

## Part Two

# Technology and Operations





# Part Two

---

## Overview

The following four chapters examine the state of industry's capability to explore for and develop oil and gas resources in an arctic environment. The spectrum of technologies and operations considered include (1) characterization of the ice environment; (2) exploring for, drilling, producing, and exporting oil; (3) logistics and infrastructure; and (4) preventing and responding to oil spills. The objective of the chapters is to describe the current state of art and then explore opportunities for conducting research or pursuing technology/capability enhancements that could materially facilitate prudent development in the U.S. offshore Arctic. Opportunities were sought that address the multiple dimensions of prudent development. Accordingly, we asked what enhancements could:

- Make operations safer?
- Reduce environmental impacts?
- Mitigate impacts on local inhabitants?
- Improve the economics of costly Arctic development?

A broad set of research and technology enhancement opportunities were identified and are summarized in the table that follows. They represent a mixed set of opportunities ranging from what could be categorized as research to design/development and demonstration projects. Consistent with the already fairly mature state of the technology, the majority would fall into the category of engineering design/development opportunities versus more basic research. It should be noted that any number of engineering-based technology improvement opportunities can be identified, but their existence does not imply that current technology is insufficient or lacking. There is and always will be room for improvement.

The opportunities were prioritized with a view toward the magnitude of impact they could have on making substantial, measurable progress toward facilitating prudent U.S. Arctic development in the next several decades. The items in the table are prioritized first on the basis of priority for prudent development of U.S. offshore Arctic oil. Categories of H (high), M/H (medium high), M (medium), and L (low) were assigned. Items within each of the categories were further prioritized by giving preference to technologies that facilitate Exploration or Both over Production. No attempt was made to further prioritize items within a category or to develop an overall prioritization. Hence, the numerical order of items in a category does not imply prioritization of say, one high priority item versus another, with the exception of demoting those that pertain to Production only.

The process for identifying and prioritizing research and technology/capability enhancement opportunities was consistently applied across the full spectrum. The technologies were first parsed into categories or areas. Subject matter experts from the industry were then tasked with documenting for each category: (1) the role of the technology in Arctic development considering all of the prudent development implications, (2) historical development and application of the technologies in the Arctic, (3) current state of the art (U.S. and global), (4) current worldwide research activities, and (5) potential technology advancement opportunities. Study topic papers were used to capture facts, draw conclusions and key messages, and to identify technology enhancement opportunities for each of the major categories considered. These papers, developed or used by the study's Technology & Operations Subgroup, are included on the NPC website. They formed the base for various study segments, such as

Ice Characterization and Offshore Arctic Exploration and Development Technologies, and were heavily used in the development of the chapters in Part Two. A list of the topic papers appears in Appendix D.

NPC study participants held a workshop to build consensus around key facts, conclusions, and messages, and to prioritize key research needs across the spectrum of technology areas. This workshop included broad representation from the study team. Priorities were assigned based on the impact the technology enhancements could make toward prudent development in the U.S. Arctic offshore over the next several decades. Since economic discoveries are required prior to any development, technologies that facilitate exploration were given more priority. The findings of the topic papers were used as background for subsequent workshops with federal and Alaskan state and local representatives to (1) inform government participants of the preliminary study findings, (2) broaden the study perspective beyond that of the NPC membership, (3) understand alignment between research opportunities and government capabilities, and (4) identify potential opportunities for government or collaborative research that would facilitate prudent Arctic development.

The basic technologies and capabilities to accomplish prudent offshore exploration and production for the U.S. waters within this study scope already exist as a result of the decades of practice and experience. Nonetheless, research to advance Arctic development technology continues, driven by relentless pursuit of gains in operations integrity and economics. The extensive list of technology enhancement opportunities identified in the table is not inconsistent with the conclusion that adequate technology already exists. There will always be opportunities to do things in a more efficient and effective manner. In fact, it is the imperative of oil and gas industry engineers to con-

stantly pursue better technology in the effort to deliver affordable energy. The majority of items identified in this study reflect continuous improvement-type opportunities that can contribute to improved operations integrity and economics. They will advance at a pace commensurate with the incentives identified by exploration and their potential for contributing to the overall prudent development objective.

In addition to technology enhancement opportunities that fall into this category of continuous improvement, this study has identified several important research opportunities—especially in the realm of demonstration trials for recent technology enhancements that could be instrumental in advancing prudent development. The highest priority opportunities are ones that both (1) address the issues of highest public concern and (2) can be key in enabling extension of exploration drilling operations beyond the open water period and into the shoulder seasons where ice is present. These include technologies that can quickly shut off the flow of oil from a blown-out well (source control technologies) and technologies for effective mitigation of the environmental impacts of spilled oil. Significant recent advancements have been made on these technologies, and there is opportunity to work with all stakeholders to build confidence in their effectiveness.

Since extended season operations involve breaking of sea ice around the drilling rig, there are also opportunities to better understand and mitigate potential impacts of these operations on ice-dependent species and the subsistence habits of indigenous people. This is discussed more in the ecology chapter in Part Three of the report. Finally, enhancements to the broad suite of technologies and infrastructure required to support station-keeping in ice could widen the boundaries of the safe extended-season operating period.

No.	Chapter	Topical Area	Primary Prudent Dev. Element Addressed	Enhancement Opportunity	Supports Exploration, Production, or Both	Priority
1	Characterization of the Ice Environment E&D Technologies Logistics & Infrastructure Oil Spill Response	Airborne Remote Sensing Aviation Logistics Ice Management Exploration Data Acquisition Escape, Evacuation, and Rescue	Safety	Increased utilization of Unmanned Aircraft Systems – Regulatory Acceptance; reduced payload size of synthetic aperture radar (SAR) and other sensors to facilitate unmanned aerial vehicle (UAV) usage. Assessment of on- and off-installation monitoring techniques to support escape, evacuation, and rescue (EER), including the provision for drones to provide information on existing and oncoming ice conditions (both local and far-field) that could impact evacuation and/or rescue success as well as the viability of evacuation routes to the evacuation points.	Both	H
2	E&D Technologies	Ice Management	Environmental	Policy-oriented studies focused on understanding and mitigating potential impacts of ice management on ice-dependent species. This would involve studies to develop a detailed characterization of marine mammal use of Outer Continental Shelf (OCS) sea ice to understand potential impact of localized ice management operations. Such studies could include development of advanced means for monitoring animal presence in very specific areas representative of those surrounding a drilling operation.	Both	H
3	Arctic Offshore Oil Spill Prevention, Control, and Response	Oil Spill Response	Environmental	Support policy that elevates all oil spill response tools (mechanical recovery, dispersants, in-situ burning, and any new/improved technology that is developed) to primary options. Decisions as to which option should be used in an emergency to minimize environmental impact will be based on Net Environmental Benefit Analysis (NEBA). Regulatory credit for all these tools should be provided when calculating how much equipment must be included in the Oil Spill Response Plan to meet worst-case discharge requirements (both at the federal and Alaska level).	Both	H
4	Arctic Offshore Oil Spill Prevention, Control, and Response	Oil Spill Response	Environmental	DOE, other federal agencies, and the state of Alaska should support pre-approval use of dispersants and in-situ burning by the Alaska Regional Response Team for all offshore OCS Alaska. Decisions regarding pre-approval should be based on sound science, including: past and ongoing research on fates and effects of dispersant-treated oil in the Arctic environment; and toxicity tests of dispersant-treated oil at realistic concentrations and exposures, and at appropriate temperatures and salinities. Pre-approval should be based on a NEBA-based approach that includes input by Industry, Oil Spill Response Organizations, academia, and other stakeholders.	Both	H
5	Arctic Offshore Oil Spill Prevention, Control, and Response	Oil Spill Response	Environmental	The NEBA-based decision process should be used in a collaborative process by government (federal, state and local) decision-makers, academia, responders, local communities, and industry to select and assess the response options that offer the greatest overall reduction of environmental impacts. This NEBA-based decision making process should be conducted for relevant Alaska Arctic regions to identify future pre-approval zones for dispersants and in-situ burning. If studies are required to support the NEBA process, DOE, other governmental entities such as the National Oceanic and Atmospheric Administration (NOAA) and the Alaska Department of Environmental Conservation, and industry should collaboratively perform them (such as the NewFields study) taking into account local knowledge. This recommendation was also supported in the National Research Council (NRC) 2014 study.	Both	H

**Recommendations from Technology and Operations Chapters**

No.	Chapter	Topical Area	Primary Prudent Dev. Element Addressed	Enhancement Opportunity	Supports Exploration, Production, or Both	Priority
6	Arctic Offshore Oil Spill Prevention, Control, and Response	Oil Spill Response	Environmental	Support the need for additional remote sensing research to enhance the ability to detect and track an oil spill in ice, including scenarios that result in oil under, trapped within, or on top of the ice. DOE and their National Laboratories should collaborate with industry to determine if any existing military technology or other research in the area of remote sensing, including satellites, can be made available and commercialized for oil spill response (OSR) use. A key consideration for this research is the need for as close to real time information as possible.	Both	H
7	Arctic Offshore Oil Spill Prevention, Control, and Response	Oil Spill Response	Environmental	ICCOPR (Interagency Coordinating Committee on Oil Pollution Research, which is composed of 15 agencies) should support the issuance of timely permits (1 year or less) to conduct Arctic oil release field experiments with lead agencies coordinating and championing the issuance of the permits. In compliance with statutory and permitting requirements, ICCOPR should encourage and facilitate controlled experimental releases of oil for offshore spill response R&D and equipment testing in coordination with regional response teams. Agencies should also include international cooperation in this area, as in the past the United States has participated and been invited to participate in controlled experimental releases in other countries such as Norway and Canada. Large-scale basin experiments to validate new technologies and strategies often precede field experiments. In that regard, continued support is recommended for the operation and maintenance of Ohmsett (the Bureau of Safety and Environmental Enforcement's [BSEE] National Oil Spill Response Test Facility, located in New Jersey) and any enhancements to facilitate more Arctic testing.	Both	H
8	Arctic Offshore Oil Spill Prevention, Control, and Response	Oil Spill Response	Environmental	Support ICCOPR as the federal body for prioritizing oil spill research. ICCOPR is designated under the Oil Pollution Act of 1990 as the means to leverage efforts of federal agencies engaged in research affecting offshore oil spill response. ICCOPR should play a strong role in conducting and/or supporting oil spill response research and technology development, both nationally and internationally, with adequate long-term support. Priorities for oil spill research should take into account available science, past and present research efforts, leverage existing joint agreements, and be addressed through a comprehensive, coordinated effort that links industry, government (federal and state), academia, oil spill removal organizations, international and local experts, and nongovernmental organizations. Interagency partners should collaborate with industry experts/consultants to evaluate selected oil spill response equipment and tactics and use this information to inform planning tools and requirements, and regulatory changes. ICCOPR should hold regular informational/educational sessions, with support by industry and Oil Spill Response Organizations.	Both	H
9	Arctic Offshore Oil Spill Prevention, Control, and Response	Oil Spill Response	Environmental	The National Laboratories should work with industry to develop an oil simulant(s) that can be used for field testing. The simulant(s), to the extent possible, needs to represent the properties of crude oil critical to testing remote sensing technologies, mechanical recovery, in-situ burning, and dispersants.	Both	H

***Recommendations from Technology and Operations Chapters (Continued)***

No.	Chapter	Topical Area	Primary Prudent Element Addressed	Enhancement Opportunity	Supports Exploration, Production, or Both	Priority
10	Arctic Offshore Oil Spill Prevention, Control, and Response	Oil Spill Response	Environmental	DOE should support development of communications strategies that explain the capability of Arctic oil spill planning, preparedness, and response to government agencies (federal and state), industry, stakeholders, and the public. The communications should include issues such as: ongoing and existing oil spill response (OSR) research and science, and rapid communication during an incident. Regulators and industry need to align on OSR expectations and ensure the public is informed.	Both	H
11	Arctic Offshore Oil Spill Prevention, Control, and Response	Oil Spill Response	Environmental	DOE and other agencies should support the process to obtain long-term permits for use of unmanned aircraft. These tools are capable of carrying multiple sensors and are small enough to be flown from response vessel. Unmanned aircraft will also expand the capabilities for 24-hour surveillance and complements the use of manned aircraft. Unmanned aircraft have much more flexibility than manned systems, but most important of all, they reduce exposure of pilots to flights in potentially hazardous conditions.	Both	H
12	Arctic Offshore Oil Spill Prevention, Control, and Response	Well Integrity	Environmental	A joint industry and U.S. government study is recommended to develop a methodology to quantify the risks and benefits of the multiple barrier technologies, using appropriately detailed reliability data and assessments. The goal of this study is to achieve source control of the well in the most rapid manner, so as to minimize the potential spill volume. The study should consider overall acceptability of risk levels, contribution of different risk mitigation practices, and other mitigations to risks that could be incorporated into arctic operations. This risk-based methodology could then be used as a basis to determine the suitable barrier requirement to prevent loss of well control, and thus serve as a performance-based requirement as opposed to the prescriptive requirements.	Exploration	H
13	Arctic Offshore Oil Spill Prevention, Control, and Response	Well Integrity	Environmental	Industry is leading efforts to enhance well capping and shut-off technology. Identification and development of technologies that can lead to material advancements (e.g., reliability, speed, and practicality) are potential areas for industry and government collaboration.	Exploration	M/H
14	Characterization of the Ice Environment E&D Technologies	Satellite Platforms Ice Management	Safety/Cost	New U.S.-controlled synthetic aperture radar (SAR) satellite to minimize reliance on other providers. Open data policy. Continue current NASA and USGS Earth-observing satellite platforms. Availability of satellite ice surveillance imagery at more reliable and more frequent revisit intervals (e.g., a U.S. public SAR satellite imagery source).	Both	M/H
15	E&D Technologies	Ice Management	Cost	Field demonstration tests to define the maximum extent of ice conditions under which modern ice management technology can reliably operate (beyond shoulder seasons successfully operated in during 1980s drilling campaigns).	Both	M/H

***Recommendations from Technology and Operations Chapters (Continued)***

No.	Chapter	Topical Area	Primary Prudent Dev. Element Addressed	Enhancement Opportunity	Supports Exploration, Production, or Both	Priority
16	E&D Technologies	Personnel Safety	Safety	Ice capable arctic evacuation craft – This R&D initiative includes the design, construction, and evaluation of a full-scale prototype craft capable of successful evacuation in a greater range of sea ice conditions than current TEMPSCs (Totally Enclosed Motor Propelled Escape Crafts).	Both	M/H
17	E&D Technologies	Personnel Safety	Safety	Mobile arctic evacuation craft with an enhanced deployment system.	Both	M/H
18	E&D Technologies	Personnel Safety	Safety	Direct transfer methods for personnel between installation and standby vessel.	Both	M/H
19	E&D Technologies	Personnel Safety	Safety	Development of an escape, evacuation, and rescue (EER) simulator that can provide close to “real life” training without the risks involved in actual deployment of the lifesaving appliances onboard the installation and support vessel.	Both	M/H
20	Characterization of the Ice Environment E&D Technologies	Drift Monitoring and Forecasting Ice Management	Safety	Improved ice drift monitoring and forecasting to aid the command and control of ice management operations and reduce operating conservatism (e.g., improved multi-day weather forecasting methods and ice drift models).	Exploration	M/H
21	Characterization of the Ice Environment E&D Technologies	Airborne Ice Surveillance Ice Management	Safety	Improved airborne ice surveillance instrumentation for broad-area ice thickness measurement and identification of potentially difficult or hazardous ice.	Exploration	M/H
22	E&D Technologies	Offshore Pipelines and Subsea Installations	Cost	Economic ice gouge protection solutions for subsea wellheads and production facilities.	Production	M/H
23	Characterization of the Ice Environment E&D Technologies	Marine Systems Ice Management	Safety	Continued advancement of marine ice radar – Enhanced ship-based ice reconnaissance capability to allow better feature resolution and tracking in poor visibility conditions and also allow discrimination of multi-year and first-year ice (e.g., enhanced marine radar or ice imaging technology).	Both	M
24	E&D Technologies	Exploration Drilling Platforms	Safety	Higher-capacity mooring systems with commensurate quick disconnect/re-connect capability for effective station-keeping in heavier ice conditions.	Both	M

***Recommendations from Technology and Operations Chapters (Continued)***

No.	Chapter	Topical Area	Primary Prudent Element Addressed	Enhancement Opportunity	Supports Exploration, Production, or Both	Priority
25	E&D Technologies	Ice Management	Safety	Arctic common operational picture (COP) is an area believed to be adequately supported by the commercial marketplace. In line with ongoing oil spill efforts, the industry should consider potential benefits from establishment of uniform practices or standards.	Both	M
26	E&D Technologies	Development Drilling & Production Platforms	Environmental	Characterization and mitigation of platform-related marine sound.	Both	M
27	E&D Technologies	Development Drilling & Production Platforms	Safety	Optimization of winterization and icing prevention technology.	Both	M
28	E&D Technologies	Development Drilling & Production Platforms	Cost	Cost-effective steels and improved qualification procedures for structural applications at temperatures below -45°C.	Both	M
29	E&D Technologies	Development Drilling & Production Platforms	Cost	Improved low-temperature ductility of lightweight concrete.	Both	M
30	Logistics & Infrastructure	Infrastructure Planning	Cost	Coordinate infrastructure planning – Local, state, and federal government agencies should coordinate infrastructure planning by carrying out, where possible, joint scenario planning to identify the intersection of mutual needs such as airfields, ports, roads, communications, to identify opportunities for investment synergies. Planning needs and considerations to include those from oil and gas industry, U.S. Navy, U.S. Coast Guard, and local stakeholders. Planning needs from the Trans-Alaska Pipeline System (TAPS) pipeline for life extension should also be included.	Both	M
31	Logistics & Infrastructure	Infrastructure Planning	Cost	Deepwater port planning – The Deep-Draft Arctic Port System Study final report, planned for mid-2015 release, should be reviewed considering the detailed functional requirements of all potential users including companies contemplating future oil and gas activity in the study area. This report is the culmination of a 3-year study conducted by the state of Alaska and the U.S. Army Corps of Engineers.	Both	M
32	Logistics & Infrastructure	Infrastructure Planning	Safety	Expanded and extended U.S. Coast Guard icebreaker role – Recognizing the potential for increasing needs in the Arctic from all industries, the U.S. Coast Guard icebreaker fleet and presence should be expanded and extended into the shoulder season to promote transportation safety, national security, and a longer exploration season.	Both	M

***Recommendations from Technology and Operations Chapters (Continued)***

No.	Chapter	Topical Area	Primary Prudent Dev. Element Addressed	Enhancement Opportunity	Supports Exploration, Production, or Both	Priority
33	Logistics & Infrastructure E&D Technologies	Maritime Offtake and Tankering	Safety	Increased support for Bering Strait and Arctic waters Maritime Safety – The United States should ratify the International Maritime Organization Polar Code to ensure that vessel traffic traversing the Bering Strait is suitably ice-strengthened and adapted to voyage safely in ice-covered waters; NOAA should complete hydrographic mapping of the region; U.S. Coast Guard should improve regional navigational and communication aids and continue development of comprehensive Arctic marine traffic awareness systems.	Both	M
34	Logistics & Infrastructure	Infrastructure Planning	Environmental	Technology for new onshore power sources – Consideration should be given to hybrid and microgrid technologies to optimize electricity generation in the sparsely populated Arctic regions as a means of increasing energy efficiency and reducing air emissions.	Both	M
35	Logistics & Infrastructure	Pipelines	Safety	Enhanced design and operational safety – Enhancement opportunities include improved passive thermosiphon design for heat removal; improved automated surveillance and security technology; improved data gathering using drone technology for pipeline routing and monitoring activities; adaptation of microelectromechanical systems for enhanced pipeline integrity monitoring and leak detection.	Production	M
36	Logistics & Infrastructure	Workforce Development	Safety	Individual companies should continue/increase discussion with local communities, state and federal agencies, and Alaska universities on workforce requirements for all sectors and how to achieve.	Both	M
37	Logistics & Infrastructure	Infrastructure Planning	Cost	Identification of gravel resources – Government should consider carrying out a study of gravel resources and usage implications across the North Slope, with focus on the region west of the Colville River.	Production	M
38	E&D Technologies	Exploration Data Acquisition	Environmental	Alternative seismic sources designed to reduce cumulative ocean noise effects, as well as mitigate potential exposure of marine mammals and endangered species that may be sensitive to impacts of conventional seismic sources (e.g., improvements to alternative sources currently under development such as marine vibroseis, or other).	Exploration	M
39	E&D Technologies	Exploration Data Acquisition	Cost	Improved subsurface handling and towing equipment and capabilities to allow for the safe and uninterrupted collection of towed seismic data in and under ice-obstructed waters.	Exploration	M
40	E&D Technologies	Exploration Data Acquisition	Cost	Improved battery/power technology to extend the useful cycle time for ocean-bottom based seismic sensor arrays.	Exploration	M
41	E&D Technologies	Exploration Data Acquisition	Cost	Improved subsea acoustic transmission capabilities for command/control/quality control and real time collection of seismic information from ocean-bottom based seismic sensors.	Exploration	M
42	E&D Technologies	Exploration Data Acquisition	Safety	Improved high bandwidth, high latitude communication systems.	Exploration	M
43	E&D Technologies	Exploration Data Acquisition	Safety	Improved ice imaging, modeling, and forecasting systems and database capability for conducting seismic data acquisition activities in the presence of sea ice.	Exploration	M

***Recommendations from Technology and Operations Chapters (Continued)***

No.	Chapter	Topical Area	Primary Prudent Element Addressed	Enhancement Opportunity	Supports Exploration, Production, or Both	Priority
44	E&D Technologies	Exploration Drilling Platforms	Cost	Bottom-founded mobile offshore drilling units (MODUs) for shallow water exploration.	Exploration	M
45	E&D Technologies	Exploration Drilling Platforms	Cost	Floating rigs for exploration drilling in moderate/deeper water depths including sea-ice incursions.	Exploration	M
46	E&D Technologies	Exploration Drilling Platforms	Safety	Further full-scale field measurements of ice loads on floating structures under different ice conditions are required to advance safety and efficient station-keeping operations in ice.	Exploration	M
47	E&D Technologies	Exploration Drilling Platforms	Safety	Technologies to support new purpose-built arctic class drillships or other specialized drilling vessels that will increase the operability window for arctic exploration drilling.	Exploration	M
48	E&D Technologies	Development Drilling & Production Platforms	Safety	Reduced offshore manning through demonstration of full system integration of automation, monitoring, and telemetry technologies for remote operation.	Production	M
49	E&D Technologies	Development Drilling & Production Platforms	Safety	A key factor in advancing design practice has been measurement and monitoring of structure loads and causal ice features. This is an area for further technology development, especially in light of the significant advancements that have been made in sensing technologies including fiber optics, etc. Installation of advanced sensors on future platforms offers opportunities to further expand industry's database of full-scale load measurements in ice.	Production	M
50	E&D Technologies	Development Drilling & Production Platforms	Cost	Designs to optimize single-season topsides mating and adaptability of topsides facilities for future modifications.	Production	M
51	E&D Technologies	Offshore Pipelines and Subsea Installations	Cost	Methods for age dating of seafloor gouges to distinguish between relic and modern gouges and hence help mitigate the need for burial depths that accommodate deep gouges that are not part of the modern record.	Production	M
52	E&D Technologies	Offshore Pipelines and Subsea Installations	Cost	Pipeline trenching methods to more efficiently attain deep burial depths of 5+ meters that may be needed for some high arctic environments where multi-year keels can interact with the seafloor and seafloor soils are soft.	Production	M
53	E&D Technologies	Offshore Pipelines and Subsea Installations	Environmental	Adaptation of new and emerging sensor technologies for enhanced leak detection and pipeline integrity monitoring.	Production	M

***Recommendations from Technology and Operations Chapters (Continued)***

No.	Chapter	Topical Area	Primary Prudent Element Addressed	Enhancement Opportunity	Supports Exploration, Production, or Both	Priority
54	E&D Technologies	Offshore Pipelines and Subsea Installations	Environmental	Special designs for minimizing or avoiding product loss from a damaged pipeline.	Production	M
55	E&D Technologies	Offshore Pipelines and Subsea Installations	Impacts on Local Residents	Improved shoreline approaches to preclude permafrost thaw or accelerated erosion.	Production	M
56	E&D Technologies	Offshore Pipelines and Subsea Installations	Environmental	Improved ice gouge databases from repeat surveys in areas where data are sparse.	Production	M
57	E&D Technologies	Offshore Pipelines and Subsea Installations	Environmental	Improved understanding of subgouge deformation phenomena with respect to soil conditions and trench configuration.	Production	M
58	E&D Technologies	Offshore Pipelines and Subsea Installations	Cost	Methods and equipment for installation of buried subsea pipelines in drifting pack ice.	Production	M
59	E&D Technologies	Offtake and Tankering	Safety	Research and training simulators for Arctic navigation – Such simulators could be used during the design process to test out various design features and to research operational techniques such as active ice-management around a drilling unit. In addition, these facilities could be used for direct training of deck officers who will be responsible for safe and efficient navigation of their ships in ice-prone waters.	Production	M
60	Characterization of the Ice Environment	Modeling	Cost	Climate modeling with focus on effects to ice cover.	Production	M
61	Characterization of the Ice Environment	Underwater Platforms	Safety	Advancements to unmanned submarine systems for possible use for real-time monitoring of ice conditions – including launch and recovery through ice, collision avoidance, GPS deprived navigation, subsea docking, recharge, and information exchange.	Both	L
62	E&D Technologies	Exploration Drilling Platforms	Safety	Enhanced positioning capability at high latitudes (geomagnetic reference field).	Both	L
63	E&D Technologies	Exploration Data Acquisition	Cost	The potential to use submarines to pull streamer cables.	Exploration	L

***Recommendations from Technology and Operations Chapters (Continued)***

# Chapter 5

## Characterization and Measurement of the Ice Environment

### INTRODUCTION

**A**rctic operating conditions can vary substantially from basin to basin and from season to season. While there are a number of different aspects of the physical environment that can have an impact on prudent exploration and development, proper characterization of the ice environment is key for safe and reliable operations and design. For example, data are used to determine seasonal operating windows for exploration drilling, design ice loads for engineering offshore structures, defining the ice strengthening (ice class) for ships operating in the region, pipeline burial depths so as to avoid damage caused by ice gouging the seabed, etc. The specific needs for defining the ice conditions will vary depending on the activity (exploration drilling; platform design; pipeline designs; logistics; escape, evacuation, and rescue [EER]; or oil spill response), and are discussed in more detail later in the chapter. It is also important to note that users of ice characterization data extend beyond the oil industry and include the U.S. Navy, Coast Guard, commercial marine traffic, fishing industry, academia, and others for their own mission requirements. Given the broad user base and industry's position that ice characterization is a noncompetitive area, our preferential model for data acquisition has been collaboration. This collaboration has included a long-time reliance on government (U.S. and foreign) assets and data products (optical and radar satellites, ice charting services provided by national ice centers, metocean data, and weather forecasting) and it is important that these continue into the future.

Industry's knowledge base of the Arctic ice environment, specific to our needs, is extensive and our understanding of the challenges presented by it have

been well developed through extensive studies over the many decades since initial interests in the Arctic offshore in the late 1960s and early 1970s up to the present day.

The focus of this chapter is to provide:

- An overview description of the Arctic ice environment with specifics to the Chukchi and Beaufort Seas
- A history of the significant studies to date that have gotten us to where we are
- Observed and projected changes to the ice environment in the next few decades
- Industry needs and standard practice for collecting and disseminating the results
- Identification of key areas of technology research with direct benefit to enhanced ice characterization.

### ICE CONDITIONS

#### General Ice Conditions in the Arctic

Ice conditions, and the challenges they present, vary widely across the Arctic. The ice in the Arctic Ocean is mobile due to prevailing winds and currents, and the area that it covers undergoes an annual cycle that varies from about 15 million square kilometers (sq. km) in late winter to about 4 to 6 million sq. km in late summer. The types of ice that influence the design and operation of offshore facilities in the Arctic include first-year ice, multi-year ice, icebergs, and drifting fragments of shelf ice known as ice islands. Depending on local conditions and overall Arctic Ocean ice transport, these primary ice types may or may not be present in a given Arctic basin.

First-year ice grows each winter to cover essentially the entire Arctic Ocean surface. Depending on weather conditions, first-year ice will generally grow to a thickness of about 1.5 to 2 meters (m). Wind and current-induced movement within the Arctic pack compresses some zones of the ice to the point of failure, which forms localized thickened areas of pressure ridges and/or rubble fields within the surrounding level ice. The thickened features, once refrozen, present the primary design and operational challenges for a first-year ice environment. Figure 5-1 shows an aerial view of first-year pack ice, which contains ridged and rubble features. Due to buoyancy effects, there is about 8 times as much ice in the keel section below the surface as in the visible sail section above.

Multi-year ice is ice that has survived two or more melt seasons. Each year around mid-September, about 5 million sq. km of Arctic pack ice persists after the summer melt season and enters the next freeze-up cycle. Surviving first-year ice becomes second-year ice; surviving second-year ice begins its third-year and is then defined as multi-year ice. Dur-

ing each freezing cycle, multi-year ice thickens and gains strength, and the loosely consolidated blocks that once made up the first-year ridge keels freeze into a solid mass. This multi-year ice presents greater challenges to design and operations than first-year ice due to its greater thickness and strength. For example, multi-year ice that is more than 4 m thick is very difficult to break with even the largest nuclear icebreakers. The largest and oldest concentrations of multi-year ice lie northwest of the Canadian High Arctic islands and north of Greenland. Some of this ice is transported southwestward and then westward across the Beaufort and Chukchi Seas by the Beaufort Gyre and southward along the northeast coast of Greenland by the East Greenland Current.

Rare but extreme ice features that occur in the U.S. Beaufort and Chukchi Seas are “ice islands.” Ice islands are large pieces of thick, multi-year shelf ice that breaks off of areas such as the northwestern coastline of Ellesmere Island. Ice islands like the one shown in Figure 5-2 can be tens of meters thick and several kilometers across and may become entrained in the Beaufort Gyre and drift into U.S. Arctic waters.



Photo: ExxonMobil.

**Figure 5-1.** *First-Year Pack Ice Containing Ridge Features*



Photo: CANATEC.

**Figure 5-2.** *Two-km-Long Ice Island Fragment Embedded in Sea Ice*

Unlike the sea ice features discussed above, icebergs are freshwater ice masses that calve off of glaciers that terminate in the ocean. Icebergs do not occur everywhere in the Arctic—glaciers that produce large icebergs exist on both coasts of Greenland and on most of the islands across the Russian Arctic such as Franz Joseph Land, Novaya Zemlya, and Severnaya Zemlya. Icebergs can range in size from a few meters to hundreds of meters with a mass of tens of millions of tons, and they present impact risks for facilities and operations. Under the current climatology, icebergs are not present in the U.S. Beaufort and Chukchi Seas.

### **Seasonal Ice Conditions in the Beaufort Sea**

Drifting pack ice can occur year-round off the Alaskan coast, although summer season occurrence has become less frequent in recent years. Landfast ice (ice that forms and remains fast along the coast, also referred to as fast ice) begins to form along the coast in shallow nearshore waters in October. By late

January the extent of this relatively stable ice zone can stretch out from shore to between 15 and 30 m of water and persist in those depths into June.

In the summer months from July to September, the fast ice breaks up and melts and is replaced by open water while the mobile pack ice retreats to the north, normally leaving the offshore drilling locations and shipping route free of ice for up to several months. The patterns and timing of ice break-up and clearing vary greatly from year to year along with the geographic extent and continuity of the ice-free window.

Recent observations show that dramatic changes have occurred in both the composition and timing of the Beaufort Sea ice cover over the past 20 to 30 years. These changes include:

- Significant expansion in summer open water duration by as much as 2 to 3 weeks (equivalent to an increase of 30 to 40%)
- Accelerating northern retreat of the ice edge during the August to October time frame as illustrated

by the ice severity index maintained by the National Ice Center

- Loss of a substantial portion of the perennial ice cover (multi-year ice) calculated recently as up to 40% by area
- Reduced stability of the landfast ice possibly related to less extensive areas of severe grounded ice on shoal areas along the North Slope.

There are three primary ice zones found in the offshore Beaufort Sea (Figure 5-3): the landfast ice zone, the shear ice zone, and the polar pack ice zone. The landfast ice zone contains a bottom-fast area where the ice is in direct contact with the seabed (extending out to ~2 m of water late in the winter) and floating fast ice, which is anchored at its seaward boundary by a complex zone of partially grounded ridge systems. The shear ice zone spans the transition from the landfast ice to the polar pack ice boundaries. An area of active ridging and rubble formation, the shear ice zone is highly variable in extent but generally occurs between the 15 m and 25 m isobaths.

The shear ice zone is composed of mainly first-year ice, with some multi-year ice that clears through the summer and the polar pack ice zone, which is predominantly multi-year ice and persists through the summer. Normally located far off the coast, the polar pack edge can advance closer to shore and into the currently proposed drilling areas (i.e., Sivulliq prospect) in extreme years. This has not happened during the past decade although some multi-year ice has been observed there.

Offshore ice concentration throughout the winter is in the range of 8/10 to 9+/10 with scattered openings and frequent leads within this so-called seasonal pack zone.<sup>a</sup> A broad, open flaw (coast following) lead often separates the seasonal pack from the landfast ice during periods of offshore wind flow (easterlies).

<sup>a</sup> Standard nomenclature for reporting ice concentrations is to report in fractions of tenths. For example, 8/10 as approximately 80% ice cover and 20% open water between ice floes; 9+/10 refers to the case where ice cover is nearly 100% but the occasional patch of water is visible.



Source: Canadian Coast Guard.

**Figure 5-3.** Beaufort Sea Ice Zones

## Beaufort Sea Ice Seasons

The offshore Beaufort Sea can be characterized by four seasons: ice break-up, a summer or open water period, ice freeze-up, and winter.

**Ice Break-Up.** Break-up is characterized by a high degree of annual variability in the ice conditions during a period of 3 to 6 weeks where dynamically changing ice concentrations mark the transition from winter to summer. Following the over flooding of landfast ice by river water in late May, initial open water corridors appear along the shore and in the lagoon areas by mid-June in most years. Beyond the barrier islands, fast ice remains stable and intact off Prudhoe Bay (in the vicinity of Northstar Island) until early July on average. By that time the sheet ice has ablated through melt to a variable thickness of 70 to 120 centimeters (cm) with numerous open holes and extensive melt ponds.

Following initial fracturing and movement of the landfast ice, the ice sheet nearshore deteriorates into increasingly thinner and smaller floes, leading to open water in late July in the vicinity of 10 to 15 m water depths.

Ice concentrations in deeper water sites (30 m and beyond) in the last half of July are highly variable, ranging from open water in unusually mild years (e.g., 1998) to a more typical condition of 7/10 to 8/10 thick first-year ice with floe sizes in the medium to big category (100-500 m to 500-2,000 m). Intermediate ice concentrations (4-6/10) are less common and generally occur for a brief period of 1 to 2 weeks from late July and early August.

**Summer.** Ice conditions in the summer months are largely dictated by the wind patterns. Persistent and predominant easterly winds tend to move the pack away from shore, promoting extensive clearing along the coast, while westerly winds tend to keep the pack ice close to shore and limit the extent of summer clearing (e.g., 2006). Open water (defined as ice less than 1/10 concentration) predominates at the drilling locations from August 20 to October 10, reaching a maximum extent in the latter half of September. Ice incursions lasting up to several weeks (often referred to as “invasions”) can occur after the initial ice clearing when the offshore pack ice is driven into shore by less common sustained westerlies and/or when thick grounded remnants of the shear zone float free in August and drift through the offshore area.

**Ice Freeze-Up.** The freeze-up transition from the first appearance of new ice to almost complete ice cover (8/10 or more) occurs rapidly with a small range of variability from year to year ( $\pm 8$  days). The first ice appears along the coast and in the lagoon areas near Prudhoe Bay in the first week of October on average. This ice generally becomes stable within 1 week following initial freeze-up.

In deeper water (typically 5 to 15 m) north of the Barrier Islands, the first continuous sheet of new ice forms on average by mid-October.<sup>1</sup> Initial ice growth rates are extremely rapid, with the sheet ice reaching 30 cm (marking the transition from young ice to thin first-year) nearshore within 2 weeks after the first occurrence of new ice at the coast.<sup>2</sup> By late October or early November, ice movements inshore of the 10 m water depth are infrequent, and the young ice is considered relatively stable out to the vicinity of the Northstar production island off Prudhoe Bay.<sup>3</sup>

Deeper water (30 m+) tends to be the last region to form new ice, and freeze-up is characterized by substantial amounts of slush in the water before the first consolidated new sheet ice appears. Ice takes longer to consolidate and progresses in a patchy fashion as wind and waves act to break up the ice as it forms (less than 15 cm). Rafting is common, as the thin ice fractures and rides over itself, forming multiple layers. A range of different ice forms will commonly occur at the same time in a localized area. In the last half of October, the ice sheet offshore is still thin enough to be easily broken in the wake of a moving vessel.

**Winter.** In the early winter period, the pack ice in the vicinity of the 30 m water depth isobath is composed almost totally of first-year ice. In recent years, ice charts from the National Ice Center in the October to December time frame reported no multi-year ice beyond trace amounts (much less than 10% coverage). Offshore ice composition at this time tends to be made up of young ice less than 30 cm thick to thin first-year ice up to 70 cm. Once the ice begins to raft and rubble in November, level ice areas are much reduced and eventually 30% or more of the ice surface can appear as deformed ridges or rubble.

Depending on the wind direction, a band of flaw leads and openings commonly occurs along the fast ice edge. The interaction between the dynamic offshore pack and the static fast ice can lead to grounded

ice features in water depths out to about 25 m and can reach elevations up to 15 m above sea level. The most active shear zone of severe ice deformation tends to be fairly narrow and concentrated between about 15 and 20 m of water, with no distinct east/west trends in severity.

Beaufort Sea pack ice in the winter moves in an episodic, meandering fashion with a net westerly drift in response to wind and currents. Ice speeds are at their maximum (typically 9 to 13 km per day) in November and December and gradually decrease as the ice pack thickens and becomes consolidated through January and February. Average speeds reach their minimum in March and April with typical values in the 2.5 to 5.0 km per day range.<sup>4</sup> Historical satellite drifter buoy observations show that the ice moves without any predominant direction for 40 to 60% of the time.

As the winter progresses and the ice becomes more consolidated, there are often periods of weeks or more with little or no ice movement in the transition zone. For example, a long-term ice drift record over seven seasons shows that the monthly incidence of no ice motion typically increases from around 20% in November to between 30 and 40% of the total time in December.<sup>5</sup> During these static periods, the boundary between the fast ice and pack ice zones becomes blurred and indistinct as the two zones merge.

## Seasonal Ice Conditions in the Chukchi Sea

Sea ice dominates the marine operating environment in the Chukchi Sea for at least 8 months of the year, from November to early July on average, 4 to 6 weeks shorter than in the Beaufort Sea.

In terms of thickness, ice severity for multi-year ice encounter and open water season is related strongly to latitude. The winter ice cover tends to be highly dynamic in response to wind and current driving forces and the predominant coastwise openings in ice cover (polynyas<sup>b</sup> and flaw leads) could provide relatively easy ice conditions for high ice class vessels even in mid-winter. To date, the only vessels that have taken advantage of this phenomenon were the Polar

<sup>b</sup> Polynyas are areas of persistent open water where we would expect to find sea ice. For the most part, they tend to be roughly oval or circular in shape, but they can be irregularly shaped, too. The water remains open because of processes that prevent sea ice from forming or that quickly move sea ice out of the region.

Class icebreakers during a series of winter research cruises in late winter during the early 1980s.<sup>6</sup>

Recent evidence shows that dramatic changes have occurred in both the composition and timing of the Chukchi sea ice over the past 30 to 40 years. Observed changes include:

- Significant expansion in summer open water duration by as much as 4 to 5 weeks (from average of 12 to 13 weeks historically in the vicinity of the Burger prospect to more than 17 weeks over the past decade). Most of the increase in season length appears to be occurring at the end of the summer, resulting in much later freeze-ups—into early December in some years for the southern Chukchi Sea.
- Accelerating northern retreat of the ice edge during the August to October time frame.

Multi-year ice floes in high concentrations (5/10 or more) can be found as far south as 70°30' N (Wainwright), but only infrequently south of 69°30' N (Point Lay). The south Chukchi Sea is mostly free of old (second-year and multi-year) ice throughout the year, except after extended periods of northerly winds when old ice from farther north can be found here.

## Chukchi Sea Ice Seasons

**Ice Break-Up.** The duration of break-up generally spans a 2-month period from mid-May at southern latitudes to mid-August at northern latitudes. Due to the latitudinal range of the Chukchi Sea, break-up will occur in the south (north of Bering Strait) much earlier than in the north (northwest of Point Barrow). In most years, the range in timing of initial break-up falls between early June to late July. The break-up period along the Chukchi coast tends to be relatively short, with ice concentrations often decreasing from almost complete ice cover to open water within a 5 to 10 day window.

In the spring, warm water influx from the south rapidly erodes the pack ice along the Chukchi coast. Winds and currents often combine to accelerate clearing of ice adjacent to the landfast ice edge as far north as Point Barrow as early as mid-May, but more commonly in late June and July.

Figure 5-4 depicts transitioning ice conditions within the Chukchi lease area in the spring of 2014.

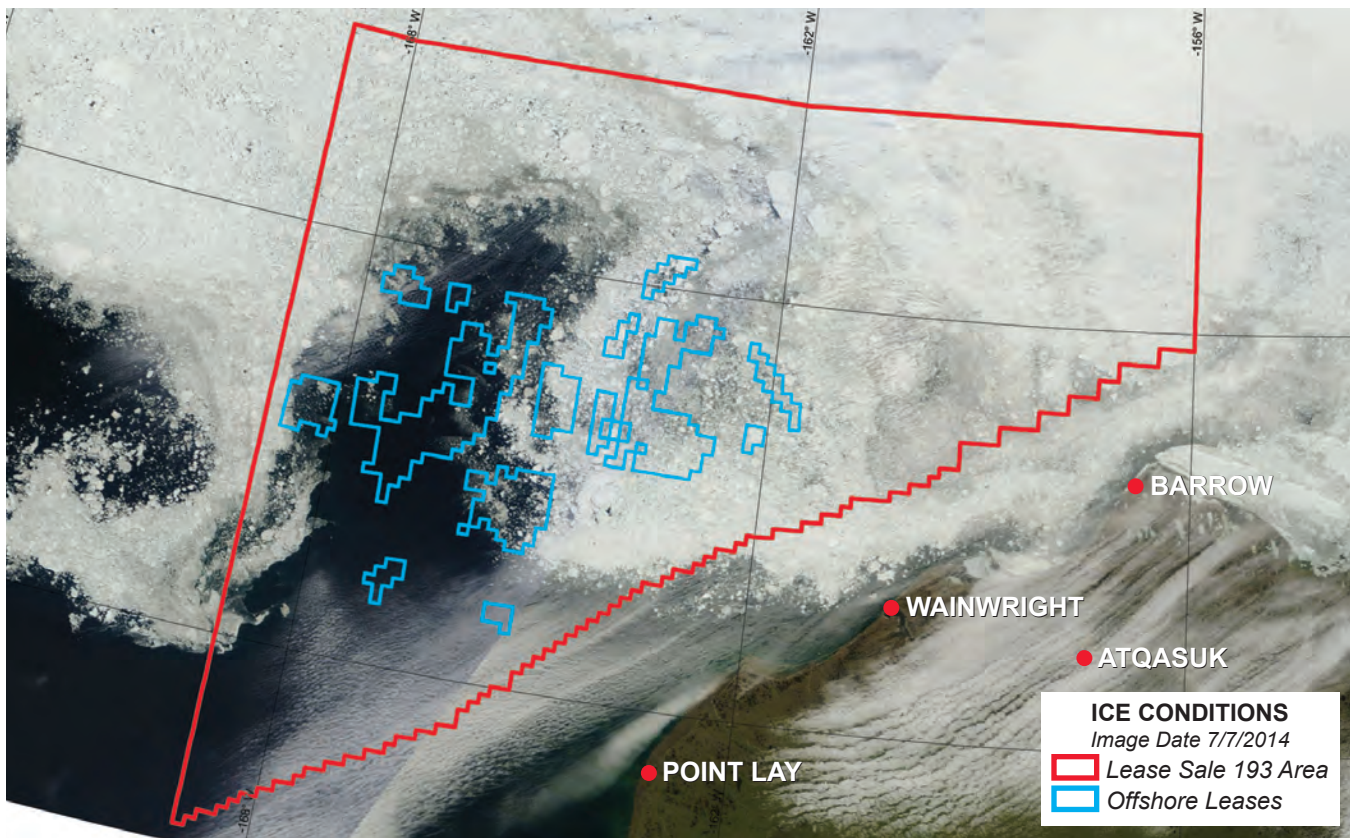

**Figure 5-4.** Late Spring, Shoulder Season, Ice Conditions in the Chukchi Sea

Photos: NASA/USGS.

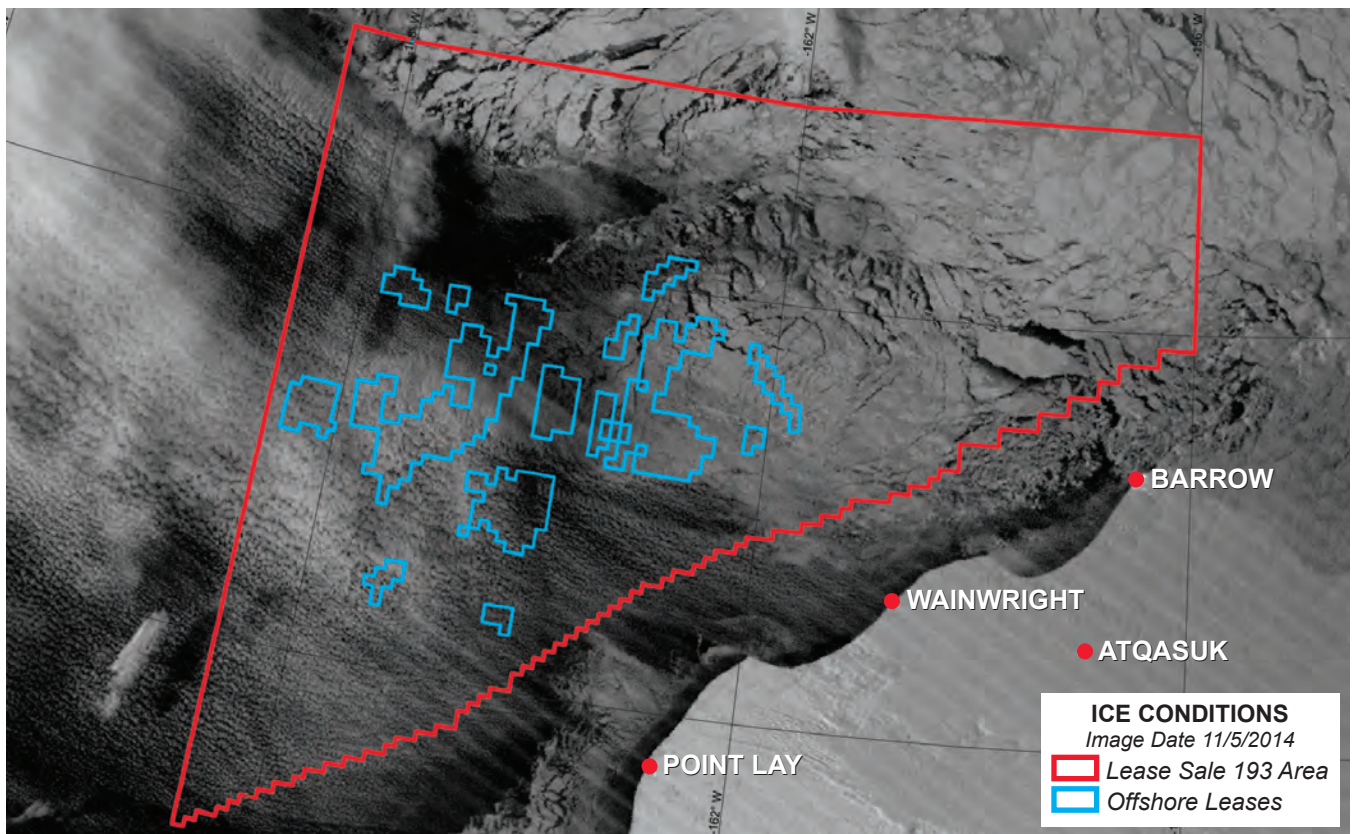

**Figure 5-5.** Early Winter Freeze-Up in the Chukchi Sea Showing Onset of Thin First-Year Ice in the Northeast Region of the Lease Blocks

During this period, referred to as the spring shoulder season, conditions can be highly variable with open water present over some of the lease acreage and high ice concentrations over others.

**Summer.** Summer ice conditions are highly variable from year to year. There is a significant south to north gradation in open water duration, from a historical average of 20 weeks or more off Cape Lisburne, to less than 4 weeks (no break-up at all in many summers) north of 72°. These durations have increased due to the recent climate warming.

Maximum ice retreat occurs in the third week of September, but ice retreat has occurred much further north in recent years. The range of open water extent is highly variable, with extreme summers seeing heavy concentrations of ice remaining as far south as 69° (historically, but not in recent years) or as far north as 75°.

**Ice Freeze-Up.** Freeze-up along the Chukchi coast begins in early October off Barrow and progresses gradually south to Cape Lisburne by late October. The occurrence of freeze-up can be highly variable both in time and space, occurring as late as the end of November in some years. Figure 5-5 illustrates the onset of freeze-up in the most northeasterly blocks within the Chukchi lease area.

**Winter.** Prevailing northeasterly winds across the northern Chukchi Sea often create an open water flaw lead or polynya offshore of the landfast ice zone along the central Chukchi coast. The flaw lead's broadest extent (up to 50 km) occurs between Cape Lisburne and Point Lay an average of 65% of the time in winter. The lead increases in frequency and extent after April.

Frequent "break-away" events can substantially alter the extent of landfast ice in a matter of hours as large floes (miles across) fracture and drift out into the polynya area. In early winter, the landfast ice remains unstable right into the coast until December. This is related to a general lack of well-grounded ridge systems to anchor the ice sheet and steeper bottom slopes in many areas. The fast ice extent tends to be a minimum in terms of seaward extent (often less than 3 km wide) along the coast north of Wainwright, in the vicinity of Point Belcher.

Winter ice drift speeds in the Chukchi average 9 to 18 km per day and can exceed 40 km per day for

a day or more. Peak ice speeds can exceed 5 km/hour for shorter periods. Offshore ice in the Chukchi Sea tends to be highly mobile for about 85% of the time in the winter. Winter winds tend to be from the east or northeast over half the time, leading to a generally low level of ice pressure along the coast and creating ice drift patterns trending to the southwest (generally against the prevailing northerly residual currents). As a result of this highly mobile ice, deformed ice (rafting, rubble, and ridging) predominates over level ice throughout the offshore pack.

Maximum late winter (March/April) thickness of level first-year ice ranges from around 1 m off Point Hope to 1.5 m in the central part (70°N) and 1.6 m or more (equivalent to the Beaufort winter pack) off Point Barrow. At the end of winter, the average calculated ice thickness along the central Chukchi coast is 1.7 m, although recent years have seen a decrease to 1.4 to 1.5 m.

## Ice Sources for the Chukchi and Beaufort Seas

There is an enormous body of accumulated knowledge, data, and published information on sea ice conditions in the Alaskan OCS, stretching back well over 40 years to the present. This overview identifies selected studies and references covering a broad base of sea ice research in the Chukchi Sea and U.S. Beaufort Sea from the 1960s to the present day. The period of highest intensity in publicly available studies of the Alaskan OCS marine sea ice environment spanned a little more than a decade from the early 1970s to the early/mid-1980s. For example, from 1970 through 1992, 452 joint industry projects related to the Alaskan offshore were performed under the umbrella of the Alaska Oil and Gas Association (Table 5-1). These projects defined, or characterized, the physical environment especially the ice environment, investigated the structural concepts required to explore and develop any discoveries and the operations of these platforms in ice environments. The subsequent decline in oil prices and along with it, industry activity in the Alaskan Beaufort, was accompanied by a general decrease in related research in that area. With more recent activities surrounding the offshore leases in the last decade, the number of ice related studies is again on the rise.

Most of the early studies in the Beaufort and Chukchi Seas focused on the Beaufort Sea break-up and

Topic	Geographical Region							Total
	North Aleutian	St. George	Navarin	Norton	Chukchi	Beaufort	All	
Ice Prop – Physical	0	8	19	17	31	90		165
Ice Prop – Mechanical							30	30
Waves	4	6	4	2	2	9	1	28
Currents	2	4	6	4	2	8		26
Geotechnical	7	4	2	4	5	14	4	40
Structures	5	6	8	5	6	24	32	86
Oil Spill						3	9	12
Whale/Mammals				1		10	1	12
Technical Development						1	18	19
Logistics		1	2	2	4	9	10	28
Cost Wells	1	2	1	2				6
								452

**Ice Prop – Physical** includes ridge and floes sizes and thickness, freeze-up, and break-up.  
**Geotechnical** includes ice gouge, strudel scour, and site surveys.  
**Structures** include measured loads, design fixed and floating.  
**Technical development** includes ice stress sensors, ice movement detectors, and measurement devices.  
**Logistics** includes pipeline and tanker studies.  
Note: Some studies were counted twice if they obtained data in the Chukchi as well as the Beaufort, etc.

**Table 5-1.** Number of Alaska Oil and Gas Association Projects, by Topic and Geographical Region (1969–1992)

freeze-up patterns, and morphology and dynamics of the floating landfast ice and shear zone. Overflights with side-looking airborne radar and laser profilers collected data on floe sizes, proportions of old ice, ridge counts, and deformed ice severity in the seasonal pack ice.

In contrast to the Beaufort Sea, the Chukchi Sea offshore marine environment remained the subject of numerous consulting studies from 1985 to 1990, the result of extensive exploration activity and development proposals from a number of companies (e.g., Shell, Sohio, Exxon, Elf Aquitaine, Mobil, etc.). In the early 1990s, increasing interest in moving North Slope gas to market led to a series of comprehensive studies of ice conditions affecting LNG port design and tanker routes serving several locations, including Kivalina in Kotzebue Sound and Wainwright on the Chukchi Coast. The 1994 Alaska North Slope Gas Commercialization Study contains some of the most comprehensive documentation of historical ice data

along shipping routes connecting the Bering Sea and north Chukchi. The paucity of new research in the public domain lasted from the 1990s through the early 2000s. A notable exception was the Northstar development and associated ice and environmental studies connected with the island and pipeline design—many of the original ice design basis reports and associated environmental assessments were filed as part of the development permit application.<sup>7</sup>

Starting in the mid-2000s, several factors in combination led to steadily increasing levels of ice research activity on the Alaskan OCS: a highly successful lease sale in the Chukchi Sea, renewed interest in developing previously explored areas in the eastern U.S. Beaufort, and new research projects involving extensive use of new high-resolution satellite image sources, sponsored by the Anchorage office of the Minerals Management Service (MMS) and involving consultants and researchers at the University of Alaska Fairbanks. During this period, industry and government-sponsored

ice studies (e.g., Shell, ConocoPhillips, BP, MMS, and Alaska Department of Environmental Conservation) examined long-term and real-time conditions within the fast ice zone and pack ice in the offshore transition zone of moving pack ice. Examples of this work include: annual surveys for density and location of strudel scours affecting the integrity of buried pipelines, sea ice over-flood boundaries affecting new developments such as Liberty and Oooguruk, reviews of landfast ice freeze-up and break-up patterns and Acoustic Doppler Current Profiles from moorings on the Chukchi and Beaufort shelf, sponsored by the oil industry.<sup>8,9</sup>

With impetus provided by the International Polar Year (2007-2008) and growing concerns about accelerating changes to the ice regimes in the Bering, Chukchi, and Beaufort Seas, a large number of studies were initiated to study the composition and dynamics of pack ice in the region. Major institutions such as the University of Washington, Institute of Ocean Sciences (Canada), the National Oceanic and Atmospheric Administration (NOAA) and the University of Alaska Fairbanks (UAF) led collaborative international efforts to study and model ice in the Beaufort/Chukchi area. The UAF, with a long history of sea ice research in Alaska, continues to lead much of the active ongoing activities related to Alaskan sea ice characteristics, composition and morphology. These activities include the following:

- *Barrow Sea Ice Observatory (1999 to present)*. UAF maintains a number of sea ice monitoring activities in Barrow that support a broad research program including studies of ice growth and melt processes, landfast sea ice dynamics, break-up forecasting, human–sea ice interactions, and range of biological and ecological studies. The principal components of the UAF’s Barrow sea ice observatory include: sea ice mass balance program (1999 to present); ice coring (1999 to present); coastal webcam (1999 to present); coastal sea ice radar (2003 to present); and local sea ice observations (2006 to present).
- *Seasonal Ice Zone Observing Network (2007 to 2014)*. The Seasonal Ice Zone Observing Network (SIZONet) is an interdisciplinary NSF-funded project that implements an integrated program of seasonal sea ice observations in the context of sweeping environmental, (geo)political and socioeconomic change in the north. In addition to sampling of sea ice state variables, the observation-system design is guided by the concept of sea-ice system services

(SISS). By assessing the nature and extent of SISS, an integrated observation network can be built that will lead to prediction of key trends in a changing Arctic in a way that provides maximum benefit for the broadest range of affected interests. In addition to the Barrow Sea Ice observatory described above, SIZONet is comprised of a number of other interconnected components:

- Airborne sea ice thickness surveys (2007 to 2014): Data from annual campaigns to measure sea ice thickness using electromagnetic techniques are available through the Advanced Cooperative Arctic Data and Information Service (ACADIS).
- Under-ice oceanographic mooring data (2009 to present): continuous time series of under-ice temperature, salinity, and ocean currents at two mooring locations near Barrow are also available through ACADIS. As of this writing, coincident ice draft measurements from ice-profiling sonars are currently undergoing final processing.
- *Leads and Landfast Ice Mapping (1994 to 2010)*. UAF has led a comprehensive analysis of leads and landfast ice in the Chukchi and Beaufort Seas relevant for offshore development activities. The final report and associated datasets provide GIS-ready grids of Advanced Very High Resolution Radiometer (AVHRR)-derived lead patterns and RADARSAT-derived landfast sea ice extent as well as monthly climatologies. A recent paper by Mahoney et al. presents a detailed summary of the landfast ice data including an assessment of multidecadal trends.<sup>10</sup>

## Traditional Knowledge

Traditional (or indigenous) and local knowledge are relevant in the study of the ice environment for a number of reasons. They can provide a long-term perspective on average and anomalous ice conditions as well as extreme ice events and hazards; inform field sampling and study design at the local level; and are relevant in the context of ice uses and adaptation to rapid climate change by Arctic coastal residents.<sup>11</sup>

Studies of indigenous knowledge of the sea ice environment have a long history, with Nelson’s 1969 study at Wainwright, Alaska, as a landmark in the field.<sup>12</sup> Recent advances owe much to the International Polar Year 2007-09, and in particular the international SIKU (Sea Ice Knowledge and Use) project, summarized in a volume edited by Krupnik et al.,<sup>13</sup>

with several contributions from the U.S. Arctic. While much more focused locally, another important effort was the Barrow Symposium on Sea Ice in 2000 that helped establish a common framework for discussing the sea ice environment from a Western and Iñupiaq perspective.<sup>14</sup> A study focusing on sea ice hazards, such as ice break-out events, ice-push events, and a general change in the stability of the shorefast ice, and on adaptations by the Iñupiaq hunting community to such decadal-scale change,<sup>15</sup> was derived from this meeting.

Building on the successes of the International Polar Year, parts of the SIKU project led by the University of Alaska Fairbanks have evolved into an ad hoc but reasonably robust network of community-based observations of the ice environment by indigenous sea ice experts in Alaska (SIZONet). The approach of this work and first results from 8 years of observations are summarized in a study by Eicken et al.<sup>16</sup> Observations include important dates in the annual sea ice cycle such as freeze-up and break-up as well as in-depth reports of ice processes (such as formation of coastal ice berms, which have been identified as an important factor in protecting the shoreline during fall freeze-up) and their impact on the community.

The Sea Ice for Walrus Outlook (SIWO) is a cooperative project that takes this approach of knowledge exchange about the ice environment one step further. In a collaboration between the National Weather Service, the Eskimo Walrus Commission, Yup'ik and Iñupiaq sea ice experts, UAF, and the Arctic Research Consortium of the United States (ARCUS), improved weather and ice forecasts, satellite data, and community-based observations of ice conditions are shared on a weekly basis to improve safety of hunters and other community members out on the ice or the water.<sup>17</sup> In the context of ice and weather forecasts, local observations and traditional knowledge can provide important feedback on the accuracy of model output in regions with complex ice circulation, strong currents not captured by simulations and ice distribution patterns not fully detectable through remote sensing.

In the context of this chapter, several points are worth noting with respect to emerging approaches and technologies relevant in capturing and sharing traditional and local knowledge. First, digital technology can greatly enhance the access as well as the extraction of specific information content from

traditional and local knowledge. This ranges from development of dedicated databases that take strong guidance from indigenous experts and communities on database design, access and other relevant constraints,<sup>18</sup> to digitization and transcription of recordings of elder and expert knowledge.

## **THE CHANGING ARCTIC ENVIRONMENT**

Changes in the Arctic environment have been an ongoing phenomenon and a topic of discussion for some time. In recent years, the ice conditions have been primarily monitored by researchers with satellite imagery, field visits, and by those who live in the region. This section describes how the Arctic has changed over the past several decades by discussing sea ice extent, sea ice thickness, and observations by Alaskan Natives. Collectively the completed work and observations made may be indicators to the future conditions of the Arctic. Effort is ongoing on the development of climate and forecast models to predict the future Arctic environment; however, spatial patterns of ice thickness are poorly represented in most climate models at this time.<sup>19</sup>

From an engineering perspective, any projected changes to environmental conditions over the time span of a project are dealt with a degree of conservatism. If conditions are projected to become less severe, the common approach is to base your design on current conditions rather than the projected “lighter conditions.” If conditions are expected to worsen over time, added conservatism must be considered in design to accommodate these changes. So from the perspective of a potentially less severe ice regime in the Arctic, the approach to design is to base it on the best understanding of current ice conditions.

### **Sea Ice Extent**

Sea ice extent has been decreasing in every season and in every decade since 1979 (Intergovernmental Panel on Climate Change, Fifth Assessment Report), with some interannual variability.<sup>20</sup> The decline has been more pronounced during the summer, almost 30% over the past 30 years, from an ice covered area of 7x10<sup>6</sup> sq. km to 5x10<sup>6</sup> sq. km. This decrease has been observed using passive microwave data, and although there may be some errors in calculating

sea ice concentrations due to melt ponds, resolution, land masking, and weather, sea ice extent has indisputably decreased.

The recent persistence of record summer sea ice extent minima or near-minima has been attributed to the depletion of multi-year sea ice and a shift to a state of predominantly first-year ice that is more susceptible to summer melting. Currently over 90% of the sea ice is estimated to be less than 3 years old. This is a stark difference to the conditions reported more than 20 years ago. In 1989, multi-year ice older than 10 years covered more than 80% of the Arctic Ocean, and by 1994 covered less than 40%.<sup>21</sup> The decrease was attributed to changes in wind and ice drift patterns due to an extended strongly positive phase of the Arctic Oscillation beginning in 1989, and it was believed that sea ice would recover only if persistent negative Arctic Oscillation conditions occurred over a number of years. Other factors that are reported to have contributed to loss of sea ice since the early 1990s include effects of a prolonged Arctic dipole anomaly and increased melting due to ice-albedo feedback mechanism, influx of warmer Atlantic and Pacific Ocean currents, and global atmospheric warming.

## Arctic Ice Thickness

Ice thickness measurements in the Arctic are most often estimated utilizing capable satellite platforms and upward looking sonar. Satellite platforms such as ICESat and CryoSat-2 launched in 2003 and 2010 respectively have the ability to provide estimates of sea ice freeboard and thickness over broad areas. Upward looking sonar from submerged platforms has been most useful in measuring sea ice thickness. Data from upward-looking sonar deployed on submarines in the Arctic extend as far back as the late 1950s. Much more local but highly detailed information from self-contained ice-profiling sonar has been routinely obtained from fixed subsea moorings since about 1990.

Most ice measurement studies over time indicate that the polar ice pack has thinned. A comparison of Arctic sea ice thickness from ICESat data collected between 2003-2008 and submarine sonar data between 1958-2000 revealed a decrease in ice thickness of approximately 50%. The overall mean winter thickness decreased from 3.64 m in 1980 to 1.89 m in

2008, an average thinning of 17.1% per decade. Additionally, ice thickness by the end of the melt season decreased by 1.6 m (53%) within 40 years.<sup>22</sup> These results suggest the gradual replacement of multi-year ice with first-year ice in the region.

Although the thickness and presence of multi-year ice is decreasing, thick multi-year ice floes and features still exist and some locations remain unchanged. Very thick multi-year ice floes (with ridges 5 to 15 m deep) are still readily found in the Canadian High Arctic two decades after the abrupt thinning of the mixed ice population of the central Arctic Ocean.<sup>23,24</sup> Similarly, a drifting ice thickness observation program across the Canadian polar shelf, (Nares Strait, Penny Strait and Byam Martin Channel) revealed that the average thickness of pack ice is identical to that measured in the 1970s and the probability distribution of thick ice is also unchanged.<sup>25,26</sup> Collectively, these studies suggest that extreme multi-year ice features are still produced in the Canadian Arctic now under much the same conditions as in the past and have been unaffected by climate change.

As one would expect, the decline in sea ice thickness is resulting in a decreasing volume of sea ice. Satellite records between 2003-2008 (ICESat) and 2010-2012 (CryoSat-2) show a decline in sea ice volume during both fall and winter season (36% and 48% respectively).<sup>27</sup>

The impact of climate change on first-year ice thickness has also been investigated in the Canadian Beaufort and northern Chukchi Seas. Studies from both areas utilizing data dating back to 1990 and 2003 for the Beaufort and Chukchi Seas respectively indicate that the thickness of first-year pack ice has not significantly changed.<sup>28,29</sup> A similar conclusion was found with fast ice thicknesses in the Canadian and Russian Arctic.<sup>30,31</sup>

## Changes as Observed by Alaskan Natives

Alaskan Natives, for whom subsistence fishing and hunting is an important part of their food supply, monitor seasonal changes to keep their activities safe and productive. As environmental changes are observed (i.e., freeze-up dates of lakes and rivers, onset of sea ice formation, spring break-ups and “brown-ups”), they are documented by hunters, thus enabling them to compare recent conditions to those of years

past. Generally, local observations validate the measured data; for example, for the past 30 to 50 years the Arctic is getting warmer, freeze-up is occurring later, and break-up is occurring earlier. In addition, marine mammal hunters (see SIWO program description in preceding section) have observed and corroborated the satellite-observed reduction in multi-year sea ice cover and its attendant effects. Examples of these effects are:

- More first-year sea ice
- Potentially less stable landfast sea ice
- Longer shoulder seasons of broken sea ice cover in the fall
- Generally more rapid retreat of deteriorating first-year sea ice cover in late springtime–early summer.

## ICE CHARACTERIZATION NEEDS

In describing ice characterization needs below, it is important to note that these describe the manner in which the available data are organized and analyzed for a particular operation rather than identifying gaps in our knowledge that need to be addressed. The way the data are described is often governed by the needs of the user. For example, engineering design for structures and vessels will focus on defining the extreme features or conditions that contribute to the limiting design whereas routine conditions are often used by others operating in the theater (coast guard, navy, shipping, tourism, fishing).

At high level, the needs for various operations are:

- *Exploration drilling.* Ice edge location, forecasts of ice edge movement, concentration and ice types if operating in ice, meteorological and oceanographic conditions and forecasts.
- *Platform design.* Statistical characterization of governing ice features that produce design-level loads (thickness, frequency, drift speed).
- *Pipelines.* Ice gouging rates as a function of water depth and any sheltering bathymetry, statistical characterization of ice keel depth and frequency of occurrence.
- *Logistics.* Routine operations, ice concentration, type, ice charts, forecasts, ice pressure.
- *Escape, evacuation, and rescue.* Statistical description of ice concentration, drift characteristics, ice topography, rubble accumulation tendencies (also

noting difference between exploration systems and platform designs).

- *Oil spill response.* Statistical description of ice concentration, drift characteristics, timing of freeze-up, transition to winter conditions, presence of leads and polynyas, operational conditions.

## Required Information for Preplanning and Design

Ice data collection and analysis during preplanning and design will build on existing knowledge and focus on building as complete a picture as possible of the ice environment. The various parameters, described in this section, are typically assembled into distributions and ranked, according to severity, thus defining light, normal, heavy, and extreme conditions. Notionally, normal and heavy conditions are used to describe the range of expected operating conditions, and extreme conditions define the limiting conditions that drive the design of vessels, structures and pipelines operating in the region of interest.

### Open Water Season

Activities such as seismic acquisition, exploratory drilling, and early phase development will most often take place in the summer period during the open water season when encounters with ice can be minimized. Key parameters used to describe an open water season include:

- *Length of open water season.* The number of days when pack ice is absent from the region or is present in concentrations less than the operational thresholds of the platform being operated.
- *Ice break-up date.* The date on which the ice concentration drops below 1/10th (or the operational threshold) and remains at that level for a period of time at a predefined operational radius around the site.
- *Ice freeze-up date.* The date on which the ice concentration exceeds 1/10th (or the operational threshold) and remains at high concentrations for an extended period of time.
- *Ice incursions (frequency and duration).* Ice from the nearby polar pack or residual seasonal ice travels through an open water area. Statistics on the frequency (number per year), duration (days), and severity (total and multi-year ice concentrations

and information on floe sizes, if available) is useful for preplanning.

### **Describing the Ice: Type, Thickness, and Floe Size**

Describing the ice by type, thickness, and floe size is important for Arctic operations to ensure that the operability of a system (platform, ice management fleet, tankers, etc.) is adequate for the expected conditions during the operating window (e.g., open water, late season with freeze-up, or year-round operations). The World Meteorology Organization, in conjunction with national ice centers (U.S., Canada, Denmark, etc.), have standardized the reporting of ice conditions describing the total concentration of ice present in a defined region, which is then further broken down into partial concentrations of ice by category type (age and thickness range) and the predominant size of ice floes present.

**Deformed Ice.** Through the dynamic processes that transport ice, level ice is frequently deformed from interactions with other pieces of ice and form ridges and rubble fields, grounded ice features, and hummocks (see Ice Conditions section earlier in this chapter).

**Ridges.** When characterizing ridges, the most commonly captured parameters include the maximum depth of the ice below the surface (keel draft), the height it protrudes above the surrounding level ice (sail height), and the length of the ridge. Ridging intensity is also an important parameter and is usually a measure of how many ridges can be expected along a given length or within a given area.

**Grounded Ice Features.** When a ridge keel or rubble feature comes in contact with the seabed, the feature can often become stationary. Another term used to define these features is *stamukha*. Grounded rubble features that remain stationary for long periods of time will consolidate into large ice masses. Occasionally, these large ice masses may have the potential to refloat, while still intact, and present challenges from an ice management or ice loading perspective. For example, Katie's Floeberg is a commonly occurring feature on the Hannah Shoal in the Chukchi Sea, composed of multiple grounded ice features some of which can refloat in summer.

**Deformed Multi-Year Features.** Multi-year ridges are typically ridges that first form through the deforma-

tion process of first-year ice (see above) and then survive multiple melt/freeze cycles. Through this process, the feature becomes more weathered and any void spaces within the ridge freeze solid. In much the same way, hummock features are highly compressed ice rubble features that have survived multiple years. Unlike multi-year ridges, which are distinct singular features, hummock fields are best described as large masses of multi-year ice that can extend tens or hundreds of meters in all directions and have thicknesses extending beyond 10 m. In regions that multi-year ridges and hummocks are present, they will often govern the calculation of design loads for permanent structures. For floating operations, they often represent “unmanageable ice,” which typically must be avoided by suspending operations and moving off station.

### **Ice Drift Trajectories**

Knowing the general ice drift behavior for a region is required for engineering and planning activities such as ice load determination, ice management, and EER measures, and for developing and validating region specific ice drift models.

### **Physical Properties of Ice**

Field measurements of salinity (or brine volume) are useful for tracking the progression of ice from first-year to multi-year. Relating ice strength to ice temperature and salinity is an important relationship that is used by engineers to calculate ice loads.

### **Extreme Ice Features**

Extreme ice features in the U.S. Arctic generally refer to ice islands and ice island fragments. These features are important design considerations for permanent structures, and understanding the risk they pose is a key objective of ice characterization studies. Likewise, understanding how a changing climate could impact the frequency of occurrence of these features in the coming decades is also required.

### **Required Information During Operations**

The type and sensitivity of the operation to changing ice conditions will dictate the need for and type of “real-time” ice data. In open water drilling, tracking potential ice incursions is required. The minimum ice feature size to be tracked will depend on vessel type,

ice class, and station-keeping system. For extended season and year-round operations, detecting potentially unmanageable features is critical. This adds the requirement for ice thickness and strength data. The areal extent over which the real time observations are required will also depend on the operations. Typically any ice within 2 to 3 days drift from the facility is monitored multiple times per day, while ice further upstream will be updated on a daily basis.

In summary, real time ice monitoring and forecasting of short-term ice conditions requires observing:

- Location and extent
- Ice drift (actual and forecast)
- Ice concentrations (total and partial)
- Ice thickness
- Pack ice pressure.

Knowing the type and amount of ice upstream of an operation enables a project to plan daily and short-term (1 to 3 days) ice management operations. Drift data and forecasts may be used to determine when ice will reach an installation. Understanding the ice concentration, thickness, and pack ice pressure moving toward the installation identifies where ice management is needed and the acceptable managed floe size. Real time ice monitoring is important in predicting if platform limitations will be exceeded.

## **TECHNOLOGY UTILIZED FOR ICE CHARACTERIZATION**

The previous section highlighted industry needs in characterizing the ice environment to enable safe operations in an Arctic offshore scenario. This section will provide a brief summary of the current practice for characterizing the ice environment utilizing available technologies. These technologies have been categorized into the following groups:

- Satellite platforms
- Airborne remote sensing
- Marine systems
- Underwater platforms
- Direct measurement
- Ice drift monitoring and forecasting.

Each of these technology groups is defined below. It is also important to note that the approach to

monitoring ice conditions will bridge across multiple technologies. A heavy reliance on a single sensor, for example, could severely impact an active operation should it suddenly become unavailable.

## **Satellite Platforms**

### **Current Practice**

Satellite remote sensing of the ice environment has been widely used for decades. Because of the remoteness of the Arctic and the large spatial area, satellite data provide the best means to provide continuous and complete long-term monitoring of the polar regions. Fortuitously, the contrast between ice and ice-free surfaces is distinct in several bands of the electromagnetic spectrum, thus allowing numerous technologies to be employed. However, all sensor types have limitations and no single sensor can provide complete information.

**Synthetic Aperture Radar.** Synthetic aperture radar (SAR) is the most utilized satellite data due to its ability to provide imagery in polar darkness, night, and periods when the area of interest may be obscured by cloud cover. Spatial resolution available from SAR satellites ranges from <5 m to 100+ m, depending on the satellite used, and can be remotely programmed to meet the needs of the client. Resolutions in the 30 to 100 m range are typically used to generate regional “pictures” of the prevailing ice conditions and produce operational ice chart products. Finer resolutions (<10 m) are used to identify and characterize specific ice features; however, they often capture a smaller scene area thus limiting their use in an operational setting. In recent years, advancements in multi-polarized beam modes have improved the ability of SAR to classify ice types and detect icebergs and ice islands in pack ice.

SAR has some limitations due to summer ice surface melt water and more ambiguity due to wind roughening than passive microwave. The backscatter characteristics of ice vary through the year, making automated detection very difficult, but this can be overcome with semi-automated processing with manual intervention provided by an expert interpreter.

**Visible/Infrared.** Ice and ocean/land are distinguishable in the visible spectrum due to different reflectance (ice is more reflective) and thermal (ice is colder) characteristics. The visible spectrum imagery

in particular is generally easy to interpret. Two significant limitations on the use of these data are the need for sunlight, limiting its use in polar regions to daylight hours between March and October, and masking due to cloud cover, which precludes its use as a reliable operational tool. Nonetheless, visible band data can be a very useful tool for characterizing the ice environment. Low sun angles in early spring and late fall, for example, can be used in conjunction with high-resolution data (SPOT, 5 m; Worldview, Quickbird, Pleiades, <1 m) to estimate the heights of ridge sails, grounded rubble features, and freeboard of ice island fragments. Data in the sub 1 m resolution range can also rival aerial photography for resolution and cost effectiveness, especially in remote locations and where large areas require surveying. Freely available data in mid (Landsat 8, 15 to 30 m) to low (MODIS, 250 m+) resolutions are also useful datasets that are available at no cost.

**Passive Microwave.** Imagery from passive microwave sensors has been available since 1972, and multichannel radiometers have been available since November 1978. These sensors have provided one of the longest satellite climate records and have been instrumental in detecting long-term changes in the ice cover.

The sensors are wide swath and can provide nearly complete daily coverage of the polar regions, but this also limits their direct use in describing the ice environment as their low spatial resolution (approximately 5 km) is too coarse for operational use. Regional scale ice charts, for instance, provide a more useable data product and are discussed below.

**Microwave Scatterometers.** Like passive microwave instruments, active microwave sensors are sensitive to water phase and thus very useful for ice-covered regions. Scatterometers measure backscatter from the surface and can provide ice extent and ice edge detection and indicate melt onset. They are even more sensitive to salinity in the ice and thus more effective in winter at discriminating ice age. Scatterometer data have been employed for sea ice extent and multi-year fraction.<sup>32</sup> Since scatterometer data resolution is very coarse (>20 km), its use is limited to large-scale ice and climate studies.

**Satellite Altimeters.** Ice thickness is a key parameter of interest for design and operation of Arctic facilities. However, most remote sensing technologies can only determine surface properties. The exception is altimetry.

Using a laser or radar, signal pulses are emitted by the sensor and the reflected signal is detected. With precise calculations, the surface height can be estimated. For sea ice, this surface height corresponds to “freeboard” or height above the ocean surface. Total sea ice thickness is calculated from freeboard using information on ice and water densities.

This technology is still relatively new, especially for sea ice, and there are several limitations. First, even with precise orbit determination, there is uncertainty in the measured signal. For ice in water, because of the density differences, 80 to 90% of the ice is below the water line. Thus uncertainty in freeboard is magnified when converting to total thickness. Snow cover is also a significant contributor to uncertainty. The small footprint size and largely vertical viewing limit spatial coverage and limit repeat visit cycles. Thus complete fields are available only at roughly monthly timescales.

Despite these limitations, satellite altimeters are now providing important information on sea ice and ice sheet thickness.<sup>33,34</sup> Currently, the large footprint size of the data limits the direct use by industry to characterize ice thickness on the scale required for operations or design.

**Use of Temporally Spaced Satellite Images.** Successive satellite scenes have been used for estimating ice movement through tracking identifiable features. Currently, the largest gap in operational use is temporal spacing of SAR images and time lag between data collection and delivery of data product to a field location. The increasing number of SAR satellites now available and being planned for launch will allow for multiple satellite images to be acquired per day to track ice movement and to update ice conditions.

**Ice Charts (Derived Product).** Ice and iceberg charts serve tactical (day-to-day) or strategic (longer-term) planning and operational purposes. They illustrate ice or iceberg conditions at a particular moment in time. The ice information is presented using a standard international code, known as the Egg Code. Satellite data, mainly SAR, is the primary data source used by national ice centers for producing ice charts, although “in-field” operational ice charts may also be produced based on localized aerial surveillance. Digitized historical ice charts, developed by the U.S. National Ice Center (NIC) and the Canadian Ice Service (CIS) since the 1970s, have been particularly useful for

defining open water season, quantifying long-term (decadal) trends in season lengths and documenting annual variability in ice conditions.

### Current R&D Satellite Systems

Advancements in satellite technologies are expected to play a crucial role in the continued advancement of ice characterization. Numerous satellite remote sensing missions with various Earth observation purposes have been planned and/or executed in Europe and Canada. These missions can potentially be beneficial to ice monitoring as they do the following:

- Provide significantly shorter revisiting period over the interested Arctic regions through the formation of constellations, such that the improved temporal resolution of image acquisitions will enable near continuous monitoring of dynamic ice conditions
- Offer high flexibility in choosing desired imagery acquisition modes whose combinations of spatial resolution and swath width are appropriate and optimized for various specific ice monitoring objectives
- Allow for existing satellite remote sensing data services to be performed at reduced costs based on projected open data
- Potentially allow the estimate of specific physical features of ice such as ice type, ridging, leads, and low-resolution thickness estimates through fusion of the data collected in multiple radar frequencies and polarization.

In addition to the conventional satellite systems, proposed small satellite systems may be able to provide powerful and cost-effective tools to react flexibly to Earth observation requirements. The motivation of most small satellite missions is to make remote Earth observation more affordable to a customer and to open application-oriented missions.

Advancements in satellite technologies are not solely limited to hardware and physical assets. Research into fully exploiting the technology through quantifying sensor performance has been critical in identifying the sensors best suited to ice surveillance.

The following are examples of current satellite technology development.

***RADARSAT Constellation Mission (RCM).*** The RCM is the evolution of the RADARSAT Program with the objective of ensuring data continuity, improved operational use of SAR, and improved system reliability. The three-satellite configuration will provide complete coverage of Canada's land and oceans offering an average daily revisit, as well as daily access to 95% of the world to Canadian and international users.

***TanDEM-X.*** As part of the Interferometric SAR mission of German Aerospace Center, TanDEM-X was launched in June 2010. This satellite is an extension of the TerraSAR-X mission, which operates as a second almost identical SAR on X-band. Flying these two satellites in a close formation with cross-track distances of 300 to 500 m provides a flexible single-pass interferometry configuration to generate global, consistent, and high-precision Digital Elevation Model (DEM). The current data product can archive 12 m planar and 2 m relative height accuracy for flat terrain.

***Sentinel.*** In the frame of the European Space Agency's Global Monitoring for Environment and Security program, a new family of missions called Sentinel is being developed for the European polar orbit satellite system. Each Sentinel mission is based on a constellation of two satellites to fulfil revisit and coverage requirements and provide robust datasets. These missions carry a range of technologies, such as radar and multispectral imaging instruments for land, ocean, and atmospheric monitoring to achieve specific objectives.

Sentinel-1A, the first satellite of the imaging SAR mission, was launched in April 2014. System design has been driven by the need for continuity of ERS/Envisat satellites with improved revisit, coverage, timelines, and reliability of service. The Sentinel-1 mission is designed to work following a preprogrammed conflict-free scenario, which means there is no need to make data acquisition requests. The two-satellite constellation offers 6 days exact repeat based on four main operational modes. As for current status, Sentinel-1A is testing its on-orbit operational qualification, and a full operation commenced in October 2014.

***ICEYE.*** ICEYE is a planned constellation of small SAR satellites, which is dedicated for Arctic ice surveillance. The design of this system was initialized in 2012 by Aalto University in Finland. An independent entity is

currently being formed to finish the system development and execute mission operation. This constellation is designed to be a dedicated commercial system, which aims to provide Arctic image acquisition service that is timely, reliable, and free of priority conflicts.

The actual configuration of constellation has not been defined, but it has been proposed that with 6 satellites' setting, less than 3 hours revisit period over an area of interest at 70 to 80 latitude can be expected. Given the proposed small payload size and limited onboard power, each ICEYE satellite is proposed to acquire at maximum 30 seconds data over the Arctic region within a single orbital pass, and then the system switches to charging mode during the rest of the orbiting period. The design lifetime of each asset is 2 years.

The main payload of ICEYE is an X-band SAR, operating on a single mode. One special feature of this system is the operation in circular polarization. This feature theoretically makes the system less subjective to the rain and fog clutter, but this polarization has not been tested on sea ice monitoring. The ground prototype is being built and a flight trial validating the sensor's imaging performance on sea ice has been planned for early 2015. The first launch of the system has been scheduled in 2016.

**CryoSat-2.** As part of the European Space Agency's Earth Explorer mission, CryoSat-2 was launched in April 2010. This satellite replaced the original CryoSat, which was lost owing to a launch failure in October 2005.

The primary payload of CryoSat-2 is a Ku-band SAR/Interferometric Radar Altimetry (SIRAL) designed to measure the ice sheet elevation and sea ice freeboard. SIRAL is the first altimeter to operate in SAR and SAR Interferometry (SIN) modes, which generates a burst of radar pulse at a much shorter interval, less than 50 microseconds. Using these two modes simultaneously has proven to significantly reduce the noise level and achieve as accurate as 1.6 cm vertical measurement resolution with 1-month temporal sampling rate over Arctic sea ice.

**Canadian Ice Service's SAR Remote Sensing Research.** The assimilation of remote sensing data from a multitude of platforms will be a valuable advancement in sea ice analysis for CIS. The development of advanced remote sensing techniques is a

strong research thrust at CIS, particularly the exploitation of SAR data. Once launched, the Sentinel-1 constellation and the RADARSAT Constellation Mission will significantly increase the amount of imagery available to CIS.

Current remote sensing research initiatives underway at CIS, in anticipation of the upcoming SAR constellations and other current and future Earth observation missions relevant to sea ice monitoring are described below.

- **Automated SAR Classification.** There are two different methodologies being examined for automated or semi-automated ice classification. One methodology, being developed in conjunction with MDA Systems Ltd, derives sea ice information from co- and cross-polarized (HH and HV) ScanSAR Wide RADARSAT-2 images using a multichannel data fusion algorithm. This method is designed for sea ice-water separation and sea ice type classification using spectral and textural information from both the HH and HV channel.

The second methodology being examined uses the MAP-Guided Ice Classification (MAGIC) software system has been designed and built by Prof. David Clausi at the University of Waterloo. MAGIC is the development platform used to implement the necessary computer vision algorithms to solve the current ice/water classification problem using RADARSAT-2 SAR imagery.<sup>35</sup>

- **Compact Polarimetry.** The availability of a compact polarimetry mode aboard the RADARSAT Constellation Mission will provide an alternative to current single- and dual-polarization SAR modes. It is understood that fully polarimetric SAR modes and associated analyses have the ability to fully explain and describe sea ice scattering. These high power modes on existing missions (e.g., RADARSAT-2), however useful for providing improved ice information, are of little operational value to the CIS and other ice services due to their narrow swath widths. The RADARSAT Constellation Mission's compact polarimetry mode has the potential to provide polarimetric-like ice information at surveillance swath widths (i.e., over 100s km). This mode may represent an important improvement over the range and type of ice information that can be extracted over large operational areas. CIS will be working with

the Canadian Space Agency (CSA) and Natural Resource Canada's Canada Centre for Remote Sensing to establish a prelaunch understanding of the potential of this new mode for operational ice monitoring.

- **SAR Ice Motion.** The CIS Automated Sea Ice Tracking System (CIS-ASITS) computes the two main components of ice movement (translation and rotation) from two overlapping SAR images that are sequential in time. The CIS-ASITS employs a phase-correlation approach to estimate both the translational and rotational components of any sea ice motion. The original algorithm has recently been ported to a new language in an effort to increase the computational speed and make it ready for full operational implementation. CIS hopes to run this algorithm on many or all incoming SAR images.
- **Data Fusion.** Two critical issues are related to an expected increase in data from the new satellite constellations: being able to fully exploit the data from different sensors and the ability to efficiently automate data processing and produce useful products. The CIS is looking at the fusion of MODIS and AMSR-E data using a regression based method; and an IHS based method to fuse RADARSAT-2 and MODIS. These methods will be transferable to future sensors.

**Canadian Space Agency—Earth Observation Applications Development Program.** The mission of the Earth Observation Applications Development Program (EOADP) is to stimulate and maintain a self-sustaining, innovative, growing Canadian industry that is able to respond to mainstream user requirements and commercialize internationally. EOADP is an essential element for the development of Canadian Earth observation and space-related capabilities, and essential for the exploitation of CSA-supported Earth observation missions. The program also prepares the industry to take advantage of CSA investments in new sensors.

Main program objectives are:

- Increase accessibility and use of satellite data
- Stimulate the development of innovative applications
- Increase the level of expertise and competitiveness of Canadian industry

- Prepare the Canadian industry to benefit from the technology advances in Earth observation.

**Enhanced Satellite Radar-Based Iceberg Detection and Sea Ice Monitoring.** A multi-year research program, conducted under the Newfoundland, Canada, R&D initiative, with a goal to develop automated techniques to optimize the effectiveness of satellite radar for sea ice and iceberg monitoring and integrate satellite-derived products into existing operations specifically for the oil and gas industry. Major elements of this work have included algorithm and software development, field validation, demonstration, and training. Based on the outcomes of the project, recommendations have been made on sea ice and iceberg services, satellite data types for these services, and information requirements necessary for successful delivery of the services.

**National Snow and Ice Data Center—Cryospheric Applications of Landsat 8.** Landsat 8 was launched on February 11, 2013, and has begun to acquire excellent images of the globe, including polar ice sheets, mountain glaciers, and sea ice. The quality of the Landsat 8 sensor supports several applications for mapping of snow and ice surfaces. This contract supports work on development of algorithms using Landsat 8 visible and thermal data for snow, ice, and sea ice research.

## Technology Enhancement Opportunities

There is a strong reliance, by all users, on satellite imagery for ice characterization, making satellites one of the most critical pieces of infrastructure required for safe and reliable operations in the Arctic. It is important to note that all of the SAR satellites (and most of the optical satellites) used are owned by foreign governments (Canada, Germany, Italy, European Union) and the highest priority for data access is often assigned to government agencies within these countries followed by commercial users. The best way to ensure the highest priority for U.S. national interests is for the U.S. government to consider an investment in a SAR satellite to minimize reliance on other providers for data.

Data costs and access can also be a barrier to advanced academic research as both real time acquisitions and archived data for most of the current satellites come at a price that is often unaffordable within university research budgets. There is a move toward

an open data policy for some of the newer satellites (Sentinel, RADARSAT Constellation) to provide the data at no cost. This would be the preferred approach for data access of any new U.S. SAR satellite.

Developing satellite technology to characterize ice thickness on the dimensional and temporal scales required for operations (sub 100 m resolution every couple of days) would be of interest although more immediate benefits could be obtained by focusing this technology on airborne platforms (see next section).

Existing satellites operated by NASA (MODIS) and USGS (Landsat) are also important tools for ice characterization and support for these platforms should continue.

## Airborne Remote Sensing

### Current Practice

Aircraft platforms can offer distinct advantages for ice surveillance and combine any or all of visual observations, optical data, or microwave data. The lower altitude provides higher spatial resolution from sensors compared to satellite platforms, and aircraft have the capabilities to fly under moderate or high cloud decks to observe surfaces not detectable by similar satellite-borne sensors. Of course, there is a significant limitation in coverage. Aircraft can only fly under acceptable flight conditions and can only cover limited distances. Repeat visits can be limited due to logistics and the cost of flight hours. Manned flight operations in remote/harsh environments also increase the exposure to risk by personnel operating in these environments. Nonetheless, aircraft can obtain validation data for satellite products and provide valuable complementary data.

**Aerial Surveillance.** Aerial surveillance through visual observation by qualified personnel enables collection of local ice cover information near the operational area in near real time. These operations will often be in the form of helicopter flights based from the operating vessel or drilling platform.

**Aerial SAR Systems.** Aircraft-based SAR systems work on the same principle as satellite SAR (see previous section) and have been used for decades in ice surveillance. Some of the earliest uses, in fact, were in support of Alaskan OCS activities in the 1980s and 1990s (STAR-1 and STAR-2 platforms). While still in

use today, the role of airborne SAR has been reduced over the years with the advent of satellite platforms. More recently, multiband SAR systems have been explored for potential use in measuring ice thickness (see R&D section).

**Photography.** Cameras mounted or used from aircraft can provide valuable qualitative information about sea ice. This can be a useful record, since an experienced analyst can note considerable details about the ice, such as approximate size, location, and quantity of multi-year ice floes and ridging, stages of development, descriptions of cracks, leads, polynyas, and location of the ice edge. Aerial photography has proved valuable to “ground truth” or validate features observed in satellite products. This helps analysts to calibrate themselves for better interpretation of satellite images. However, unless flying low (<150 m), it is difficult to estimate details like ridge height and rubble size, since spatial references are difficult at altitude. Another issue is that it is difficult to georeference features.

**Electromagnetic Sensors.** Electromagnetic induction (EMI) sounding devices have been developed that are dedicated to the measurement of sea ice thickness. With EMI sounding, the distance between an EMI instrument and the ice/water interface can be determined by means of active induction of eddy currents in the water and measurements of the resulting secondary EMI field amplitude and phase. The method relies on the strong electrical conductivity contrast between the conductive seawater and resistive sea ice and snow. No induction takes place in the latter, and the derived thickness is total thickness (i.e., ice plus snow thickness). In addition, the distance between the EMI instrument and the snow/ice surface needs to be determined. EMI measurements can be performed while walking or driving over the ice (e.g., by snowmobile). They can also be carried out from helicopters and airplanes, wherein the EMI sensor is typically tethered to avoid induction in the metal of the aircraft. EMI fields strongly decay with height above the water. Therefore EMI sensors need to be flown low above the ice, typically less than 30 m. The low-frequency EMI fields in the kilohertz range are diffusive and result in a large measurement footprint of 2 to 4 times the flying altitude, over which measurements are averaged. Therefore the maximum thickness of ridges is usually underestimated since the EMI footprint averages across the maximum

ice thickness in the ridge keel and adjacent thinner ridged or level ice.<sup>36</sup>

**Light Detection and Ranging (LIDAR).** LIDAR is an active remote sensing technology, similar to radar, that transmits laser pulses to a target and records the time it takes for the pulse to return to the sensor receiver. This technology is currently being used for high-resolution topographic mapping by mounting a LIDAR sensor, integrated with Global Positioning System (GPS) and Inertial Measurement Unit technology, to the bottom of aircraft and measuring the pulse return rate to determine surface elevations. With LIDAR mounted to an aircraft, it is possible to create swath maps of sea ice freeboard and surface elevations.

### Current R&D Airborne Systems

Some of the most operationally challenging aspects of satellite operations are: (1) revisit times to specific Areas of Interest; (2) uncertainty in acquisition, especially if orders are made on a short notice; and (3) lack of control over the satellite acquisition modes and coverage to optimize the results. It is therefore believed that airborne ice reconnaissance will remain as a complementary tool to satellite surveillance for some time to come. This section focuses on presenting the need for acquiring detailed ice information in real time using airborne sensors to evaluate ice-induced hazards on offshore facilities. Specific focus will be given here to all weather/wide swath sensors, mainly radar systems as premier candidates of supporting Arctic drilling operations.

With regard to radar systems, it can be observed over the last few years that airborne reconnaissance research efforts in Europe have been focused on developing and testing multiband/multi-polarization SAR systems. These systems can prove beneficial in the area of ice characterization as they:

- Feature a reconnaissance approach that balances between high resolution associated with high-frequency radar systems such as X-band, and lower weather attenuations associated with low-frequency radar systems such as P-band
- Provide the ability to classify different ice features based on topography using advanced signal processing algorithms of different bands and polarizations
- Allow making direct measurements of ice thickness remotely through employing low- and high-frequency radar bands.

In addition, a multi-sensor airborne approach provides some redundancy that can be beneficial if a sensor malfunctions.

In addition to radar systems, ground penetrating radar and EMI, but mainly EMI, have been used to measure sea ice thickness and aid in predicting its breakability.

The following are examples of current activities.

**Fugro GeoSAR.** The Fugro GeoSAR Sea Ice Mapping technology is a single pass, wideband, dual frequency (X-band and P-band) interferometric airborne radar mapping system mounted on a Gulfstream II jet aircraft. The system is designed to acquire sea ice data at a rate of 288 sq. km per minute, enabling large-area coverage over Arctic regions.

Sea ice thickness measurements include characterization of first-year sea ice from multi-year sea ice, as well as the identification of cracking ice networks and ice ridges. These measurements are developed utilizing a combination of the 3 m X-band and 5 m P-band digital terrain models, 1 m orthorectified magnitude imagery, and volumetric decorrelation data. Data are developed in the field, using a specially designed workflow that processes the raw radar data into sea ice mapping deliverables, available to clients within hours of the airborne mission. These data provide actionable intelligence for assessing the risk of oncoming ice conditions and enabling operators to mitigate high-risk ice floes from fixed locations in the Arctic.

**F-SAR (Microwaves and Radar Institute/German Aerospace Center).** F-SAR is the newer generation of the E-SAR, operated by The Microwaves and Radar Institute of the German Aerospace Center (DLR). F-SAR was developed to focus on simultaneous data acquisition at different wavelengths and polarizations at very high range resolution, a capability that was limited in the E-SAR. F-SAR also operates on the DLR's Dornier DO228-212 aircraft. F-SAR features X-, C-, S-, L-, and P-bands with simultaneous all polarimetric capability. Range resolution is determined by the available system bandwidth. A special antenna mount that holds seven right-looking dual polarized antennae is used (i.e., 3 X-band, 1 C-band, 2 S-band, and 1 L-band). The P-band antenna is mounted under the nose of the aircraft).

The authors could not find publicly available information about the use of this system for Arctic characterization; however, a system like the F-SAR that features multi-band/quad polarization capabilities can potentially provide significant improvements in small ice feature detection, sea ice classification, and making direct measurements of ice thickness.

***Near Real-Time Ice Thickness Measurement Technology Development.*** A project, funded by industry operators in Newfoundland, Canada, was initiated to identify technology for acquiring, processing, and reporting in near real time, ice thickness over a wide swath. A practical solution is an airborne multi-radar system. The activities of this feasibility study included a thorough literature review, a survey of client requirements, and an investigation of available commercial sensors. Results of the study recommended the development of a prototype instrument to combine two commercial radar sensors—an impulse radar for ice thickness profile measurements and a polarimetric synthetic aperture radar (polSAR) for surveying large swaths. The impulse radar data will calibrate the SAR data and output a map of ice thickness over the surveyed area. The final package would be suitable for deployment on an aircraft. The proposed technology development would see an integrated sensing unit using advanced algorithms, processes, and models based on the radar data to generate tactical, near real time ice thickness maps for offshore operators.

***Autonomous Flight Platforms.*** Manned flight is seen as an elevated safety risk for many operators and investigators in the Arctic, due to frequently poor flying conditions, limited choice of airframes, range limitations, minimal aviation infrastructure, and emergency response times. The goal is to move aviation-based science observations and measurements to unmanned platforms. In recent years, there has been good progress testing unmanned aerial systems (UAS), also called drones, in the Alaskan offshore through the Alaska Center for Unmanned Aircraft Systems Integration (ACUASI) at the University of Alaska Fairbanks. In December 2013, ACUASI was selected by the FAA to operate one of six UAS test sites that will lead to the eventual approval of UAS use in U.S. airspace. It is practical to assume that most of the observations and measurements currently possible on manned aircraft are achievable on UAS platforms. The expectations are that once fully operationalized,

UAS will provide more data due to lower operating costs, longer flight times, and greater availability.

## **Technology Enhancement Opportunities**

The largest impediment limiting a broader use of unmanned aerial systems are current regulations governing the use of UAS in U.S. controlled airspace. Efforts should continue to demonstrate safe operations of UAS that will allow the FAA to move forward with respect to defining regulations for UAS use in remote, low-density air space, such as the Alaskan OCS. The prospect of increased utilization of these systems would likely lead to more rapid advancement of work on reducing payload size of SAR and other sensors to allow for the use of smaller airframes.

Additionally, continued research and field validation is needed for multiband SAR and/or SAR and impulse radar to improve airborne ice thickness surveillance. This has the potential, through ice thickness surveys over broad areas, to identify potentially difficult or hazardous ice.

## **Marine Systems**

### **Current Practice**

***Marine Radar.*** Marine radars are used routinely to detect and avoid ice hazards. Recent advancements in “ice radars” utilize specialized workstations installed on vessels that combine advanced video processing and geospatial mapping tools. Based on the Rutter Sigma S6 scan-averaging signal processor, integrated systems like the Enfotec IceNav and Ion Narwhal allow high-resolution imaging of ice, including small, slow-moving features, over the range of the radar, which is typically to the horizon. Using the geospatial tools, georeferenced data such as satellite imagery, weather surface maps, and ice charts can be overlaid and individual ice targets can be tracked.

Unlike satellite radar, marine radar has difficulty distinguishing between first-year ice and old ice, but is currently an area of ongoing research.

***Ship Transits.*** Ice observers’ logs can be used to extract ice thickness, sail height data, ridging intensity, and the occurrence of pressured ice. If a time stamp and location information are included, the logs can also be useful for ground truthing, particularly with archived satellite imagery when available.

**Shore-Based Marine Radar.** Marine radar systems have been successfully used to monitor nearshore ice locations in Alaska. Operated by the University of Alaska Fairbanks, these 10-25 kW X-band radars are mounted on buildings near the coast in Barrow and Wales and have a range of approximately 10 km. These systems produce still images and animations for observation of ice movement, deformation, break-out events, and stability of fast ice.<sup>37</sup>

## Marine Radar Research

The use of marine radar for ice detection and tracking is a major research area, especially in Canada.<sup>38</sup> Current research is centered around improving ice tracking capability of slow moving ice targets and mitigating rain clutter effects on radar detection performance potentially through one or more of the following techniques:

- Increasing the sampling rate through increasing the pulse repetition frequency or scan rate
- Increasing dwell time and thus improving the signal to noise ratio
- Increasing power level and gain (size)
- Decreasing beamwidth, which decreases angular tracking noise
- Using multiple polarizations
- Using longer wavelength radar bands than X-band, typically S-band
- Advanced signal processing such as scan averaging.

Two advanced marine radar systems that are being used for ice characterization have been identified. These are: (1) The Selesmar Selux system developed by Consilium (Sweden) and (2) Rutter Sigma 6 marine radar (Canada).

**Selesmar Selux Marine Radar.** This is the fifth generation radar developed and manufactured by Selesmar Consilium, three of these radars recently replaced old systems on the Hibernia platform offshore Newfoundland in Eastern Canada. This system features:

- Automatic identification system that allows identification of up to 100 targets
- Automatic radar plotting aid that allows creating tracks and calculates the tracked object's course, and speed, thereby knowing if there is a danger of collision with other ships, ice features, or landmass

- An advanced guard zone system has been introduced, which automatically checks all targets around the vessel against the specified minimum safe parameters and provides acoustic and visual warnings when necessary.

**Rutter Dual-Polarized Ice Hazard Radar.** This is a program to further advance the development of an integrated dual-polarized ice navigation and detection radar. The project has included field trials of the system in the Canadian Arctic and northeast Greenland with further development planned. This has been a multi-year program with additional support from other funding agencies (Canada's Program of Energy Research and Development, Transport Canada) and support in kind from the Canadian Coast Guard and industry-supported field expeditions.

## Technology Enhancement Opportunities

Technology advancements in marine radar systems, with focus on hazardous ice feature detection, is an area of high interest. Research is ongoing through collaborative efforts between the technology developers, the Canadian government (Coast Guard/Transport Canada) and industry-sponsored trials. The main challenge is to distinguish between first-year and multi-year ice. While the main focus of this initiative is based on marine transport through northern routes, ice management activities are also likely to gain efficiencies through improved ice classification.

## Underwater Platforms

### Current Practice

Technology and logistics capability for wide-ranging, all-season surveillance of sea ice thickness lags far behind that for mapping the presence, concentration and type of sea ice. There are two reasons: first, sea ice is largely opaque to electromagnetic radiation that might otherwise be used to map its thickness from aircraft or satellite; second, sea ice thickness varies appreciably over distances of 1 to 10 m that are difficult to resolve from great distance in space. Although progress is now being made in the development of topside remote sensors to address these challenges, it is acoustic remote sensing from submerged platforms that has been most useful in providing information on sea ice thickness and its variations during the past half century.

Ice measurements from submarines or subsea moorings share two attributes that inhibit their use in tactical (i.e., real time) support. These are the difficulty of targeting surveys where and when they are needed, and the difficulty of timely delivery of data from the survey platform to operations. In consequence, with the exception of the obvious tactical value for naval operations, data from subsea sonar have to date generally been used strategically, providing great value in the conceptual planning of offshore operations (e.g., rig supply, cargo transfers at sea, product loading and transshipment, spill countermeasures) and in defining the extreme conditions of loading that offshore structures, their foundations or anchoring systems, seabed pipelines, and ships must be designed to withstand.

**Autonomous Underwater Vehicles (AUVs)/Submarines.** The method of using sound waves to derive the thickness of floating ice is straightforward. A single-beam sonar is positioned looking directly upward at a depth safe from moving ice (>35 to 50 m); the depth of the sonar is determined from the difference between measured total pressure at depth and local sea level atmospheric pressure, with knowledge of the ocean density profile enabling conversion from pressure to depth. The distance to the bottom of the ice is determined from the echo travel time, with knowledge of the ocean sound speed profile allowing conversion from travel time to distance. The ice draft (roughly 90% of its thickness) is calculated as depth minus distance to the ice, and ice thickness is estimated from knowledge of the ratio of sea ice to seawater density, assuming local isostasy.

Upward-looking sonar was deployed on nuclear submarines (United States, Russia, United Kingdom, France) in the Arctic starting in the late 1950s, for navigational purposes and later scientific analysis. Resolution has been appreciably poor for submarine systems because of wide beamwidths (2-5°) and depth of submergence (up to several hundred meters). Accuracy is in draft ranges between  $\pm 0.05$  and  $\pm 0.5$  m, depending on how well density and sound speed are known in the overlying ocean. Observations from submarines developed a vast database of ice thickness distributions, distributions of pressure ridge depths and spacings, and occurrence of leads.

Submarine sonar surveys ice-topographic transects in the conventional manner: the navigational

data from the fast-moving vessel defines the survey track below the ice, typically the slow ice drift during the surveys is ignored.

Advancements in unmanned AUV technology enable similar observations to be made by civilian operators. These missions can be run in shallower water and have more flexibility for the survey location and study timing.

**Fixed Moorings.** Self-contained ice-profiling sonar (IPS) was developed for scientific purposes in the 1980s and has been in routine use from fixed subsea moorings since 1990. A narrow acoustic beam is a key design feature of the under-ice sonar. The 1-2° beam of the IPS provides nominal resolution on the order of a few centimeters of under-ice topography from normal operating depth as the pack ice drifts overhead. IPS in the southern Beaufort Sea surveys 1,000 to 3,000 km of ice annually.

The IPS on a mooring measures the under-ice topography as a time series, thereby accumulating a distorted geometric picture of ice topography as the speed and direction of drift changes. If an acoustic doppler current profiler (ADCP), deployed either nearby (shallow water) or on the same mooring (deep water), is paired with the IPS to measure the ice drift at high temporal resolution (sub-hourly), a trajectory of the drift can be calculated. A locally accurate topographic transect can be calculated by mapping the ice draft values onto the trajectory. If the data are subsequently re-sampled to equal increments (1 m) of distance along the trajectory, spatially weighted statistical properties of ice draft can be evaluated. Over short intervals of time (days) these statistical measures are analogous to those from submarines; over longer intervals (weeks to months) they track changes in the pack ice forced by storms and over the cycle of seasons.

An added advantage to the IPS/ADCP mooring method is that these instruments also measure profiles of the water currents and water temperature at the depth of the sensor at high temporal resolutions (<1 hour) and can estimate wave heights and periods during periods of open water. While the IPS/ADCP pairing generally works well, it can be complicated by the need of two moorings and data are recorded to separate internal loggers that require reconciliation during post processing. Recently, similar utility to the IPS/ADCP combination has been achieved using a single instrument. The Nortek AWAC (Acoustic Waves

and Current) contains the vertical sonar and inclined Doppler sonar transducers and has been demonstrated in the U.S. Beaufort Sea.<sup>39</sup> Aside from simplifying the mooring and data reconciliation issues of the IPS/ADCP, it can also estimate directional wave parameters.

**Multibeam Sonar.** Single-beam sonars on underwater platforms provide valuable data on under-ice features, but they provide a linear, two-dimensional view. In 2004, a multibeam sonar, commonly used for bathymetric surveys, was mounted upward looking on the Autosub AUV to survey the underside of the ice canopy. This effectively expands the field of view several tens of meters wide, capturing a 3D elevation (depth) swath of the underwater surface of the ice. With these observations, first-year ice features are easily distinguished by their sharp, rough character, while older multi-year ice becomes apparent due to its smoother, weathered appearance. This cross-track view also gives a better estimate of the overall volume of submerged ice features and highlights the highly irregular shape of ridge features. Multibeam sonar has also been successfully used to survey the underwater profiles of icebergs, on Canada's east coast, by mounting the unit on its side onto a remotely operated vehicle (ROV) operated from a nearby support vessel.

**Sidescan Sonar.** Similar to the application of multibeam sonar, sidescan sonar can capture a wide cross track swath of the underside of the ice when used inverted (upward looking) on an underwater vehicle. Where multibeam sonar measures the time travel of an emitted acoustic pulse reflecting off of a surface, sidescan sonar measures the intensity of the returned pulse. Surfaces with a lot of roughness results in more reflected energy than smooth surfaces. Multibeam sonar is generally preferred, since it, unlike sidescan sonar, can estimate the depth or draft of the canopy over the entire swath. However, sidescan can outperform multibeam when it comes to resolving detail or small features. Sidescan sonar can measure range to a target and using this information, the keel depth along the path of travel can be estimated much like the upward-looking single-beam sonar discussed earlier.<sup>40</sup>

### **Subsea Ice Characterization Technology Research**

There are two major systems that fall into this category. The first of these is the moored ice-profiling sonar. When deployed with an ADCP, ice velocities/

trajectories and ocean currents can be calculated to add a spatial component to the ice drafts. While the measurement technology is mature, interpretation of these data is the subject of ongoing research. Given the draft profile of ice drifting over the sensor location, it is important to be able to classify the record by ice features (e.g., first-year/multi-year ridges, etc). Algorithms have been developed by different organizations that accomplish this task but validation of the results is challenging in the absence of on-ice corings or other defensible measures of ice age.

AUVs can survey remote environments that are inaccessible to other submersibles (e.g., ROVs and submarines) and are completely autonomous, which results in high efficiency through increased survey speed. They can be instrumented with a variety of sensors and provide a very stable and low-noise platform for measurements. Several system manufacturers are working to extend AUV range through improved capacity of batteries or fuel cells, which may also lead to applications of AUVs for inspection, maintenance and repair of subsea installations. Navigation under ice and launch and retrieval systems are also areas being improved. Advances in sensor technology designed specifically for AUVs will allow each mission to carry more extensive measurement programs. Longer-term development plans for the systems involve AUV gliders with a range of thousands of kilometers, AUV deployment from the air, underwater docking systems to mitigate risks associated with launch and recovery operations, and an AUV's ability to cooperate thus allowing a team of vehicles to communicate and adapt to changing conditions of the mission.

### **Office of Naval Research Programs**

The Office of Naval Research (ONR) Arctic and Global Prediction Program is motivated by the rapid decline in summer ice extent that has occurred in recent years. One of the focus areas of this program is investigating new technologies (e.g., sensors, platforms, and communications, for sustained operation and observation in the challenging Arctic environment). From this, the following programs have been undertaken.

- *Evolution of the Marginal Ice Zone: Adaptive Sampling with Autonomous Gliders.* Seaglidors have been deployed in the Beaufort Sea as part of the ONR "Marginal Ice Zone" project. They will obtain

water temperature and salinity, microstructure, and bio-optical data as they undertake surveys between late July and late September 2014. All data will be stamped with GPS positions obtained from a network of acoustic sources, which will also send adaptive sampling instructions to the gliders—see entry on acoustic communications and navigation below. Data are stored aboard the floats until they are able to surface and communicate via the existing Iridium satellite communication system.

- *Wave Gliders for Arctic MIZ Surface Observations and Navigation Support.* As part of the ONR “Marginal Ice Zone” project, two wave gliders, each equipped with an automatic weather station and an underwater acoustic source, were deployed in the Beaufort Sea in late July 2014. The acoustic sources supplement an array of sources deployed in March 2014. The wave gliders were due to be recovered in late September 2014.
- *Acoustic Communications and Navigation for Mobile Under-Ice Sensors.* Eight acoustic sources (25 Hz bandwidth, 900 Hz carrier, 183 dB SPL) were deployed in the eastern Beaufort Sea in March 2014. Suspended ~100 m below the ice, the sources provide communications and navigation services to eight polar profiling floats and four sea gliders (see above).
- *LDUUV (Large Displacement Unmanned Undersea Vehicle).* The LDUUV is an Innovative Naval Prototype for a reliable, fully autonomous, long-endurance unmanned undersea vehicle capable of extended operation (60+ days). The LDUUV might be tested in Arctic waters.

### Technology Enhancement Opportunities

Arctic-class autonomous underwater vehicle systems are a technology with potential for increased use for ice and environmental study and possible surveillance for developments. Key areas that need focus are:

- Launch and recovery through ice
- Collision avoidance
- GPS-deprived navigation
- Subsea docking, recharge, and information exchange.

## Direct Measurements

### Current Practice

The previous sections discussed remote sensing methods that do not actually come in contact with the ice and can perform their observations or measurements at a distance. While many of the remote sensing techniques excel at supporting wide area characterization, they tend to do so at the expense of spatial resolution. In some cases, the results of remote sensing surveys are inferences or proxies based on clever processing. Direct measurements, on the other hand, are those where the investigator or instruments are in contact with the ice it is measuring. These methods are capable of performing highly detailed measurements at a point or of a particular specimen, but they tend to be impractical for wide area characterization. However, when combined with remote sensing methods or used as a basis for validating remote-sensed estimates, reasonable characterizations over wide areas can be obtained.

**Drill Holes.** Direct measurement of ice thickness can be obtained by drilling a hole through the ice with an auger, corer, or steam drill and utilizing a tape with a deployable anchor to measure the distance from the bottom of the hole to the surface. Single-point measurements of this sort are poor characterizations of the pack ice since this yields a purely local estimate and there are likely many ice types and variations in floe thickness over short spatial distances.<sup>41,42</sup> Therefore, multiple measurements at a site must be made—a time consuming activity unless a steam drill is employed.

Other relevant variables can also be measured while drilling, such as information on snow thickness, ice elevation, draft, thickness, and void spaces in deformed ice, but such measurements are slow and laborious and therefore unsuited for routine monitoring or wide-scale characterization.<sup>43</sup>

**Coring.** Many studies require extraction and direct examination of samples obtained from an ice cover, in particular research into physical, chemical, and biological properties of sea ice.

The prevailing method for obtaining ice samples is to drill cylindrical ice cores. Typical corer diameters are on the order of 10 cm, a compromise between obtaining ice volumes large enough to minimize

sampling errors while keeping core weight and bulk at a manageable level.

**Borehole Indenter.** The borehole indenter system provides a convenient means of measuring a vertical strength profile through the full ice thickness. Therefore, it remedies some of the problems associated with conventional strength tests that use specimens obtained from the uppermost few meters of ice. Borehole strength tests provide a measure of the in situ confined compressive strength of the ice in an augured or cored borehole (borehole strength). The borehole strength is useful for calculating forces on structures (particularly crushing against a vertical face) and for verifying the integrity (bearing capacity) of floating ice.

**Temperature.** Thermistor strings can be deployed through ice holes and allowed to freeze in place, which will allow for measuring the vertical temperature gradient in the ice. Temperature is an important variable in determining the strength of ice, with lower temperatures suggesting stronger ice.

**Salinity.** Ice salinity is obtained by measuring the electrolytic conductivity of melted samples collected in the coring process.

**Satellite Tracked Drifting Beacons.** Surface Velocity Program beacons are small satellite tracked devices that report positional data at regular intervals (typically hourly). They can be outfitted with sensors to report sea level air pressure and surface air temperature. Depending on their construction, they can be deployed by hand, tossed from a ship, or deployed from an aircraft.

Their primary purpose is to drift with the ice, providing a record of vectors of the ice motion. This is used to characterize various traits of the ice movement, such frequency of movement/stasis, speed and direction, and distance travelled. If drift beacons are deployed in an array, study of relative movement of the ice and rotation is possible. When barometric pressure and temperature are available, these data are assimilated into Numerical Weather Prediction models that are used to forecast, and into the many long-term atmospheric reanalyses (e.g., National Centers for Environmental Prediction and the National Center for Atmospheric Research (NCEP/NCAR) Reanalysis) that are used for innumerable climate studies.

An Air-Deployable Expendable Ice Buoy (AXIB) can withstand multiple freeze-thaw cycles and operate equally well in ice-prone ocean or fresh water. The AXIB can be dropped from an airborne platform, land on an ice surface, right itself to the vertical position, anchor and stabilize itself in the ice, and continue to transmit data while anchored to the ice or floating in the ocean.

## Ice Drift Monitoring and Forecasting

### Current Practice

The final area of Arctic characterization research is ice drift monitoring and forecasting. Ice drift monitoring and forecasting are key components of an ice management system, because it is crucial to know where the ice is coming from and to estimate where it is going in order to efficiently deploy ice management resources. Ice drift monitoring and forecasting can be classified into two primary regimes: near field and far field. Near field (or tactical) ice drift monitoring and forecasting focus on short-term ice drift motions, while far field (or strategic) focuses on regional scale ice motion.

Ice drift monitoring involves tracking the motion of ice as a function of time. Monitoring can be accomplished in several different manners, including satellite imagery, aerial surveys, enhanced marine radar, and by deployment of beacons directly on floes of interest. Each of these methods has tradeoffs that must be considered when selecting ice monitoring methods. For instance, analysis of successive satellite images or aerial surveys provides estimates of ice motion with coarse temporal resolution over a relatively wide region. In contrast, enhanced marine radar and beacons deployed directly on floes of interest provide high temporal resolution of individual features. The type of ice drift monitoring required will likely depend on the ice concentration during ice management operations—broad, lower temporal resolution will be needed when operating in high concentration conditions such as in pack ice, while high temporal resolution feature tracking will be needed when operating in low ice concentration conditions characterized by isolated floes along the marginal ice zone.

Depending on ice concentration, the physics of ice drift forecasting change. For low concentration conditions, the ice drifts freely, while under heavy

concentration conditions, the ice does not drift freely. This can be clearly seen in ice drift records. In low concentration conditions, isolated floes tend to show strong inertial motion characterized by cusps and loops in the drift paths. In high concentration conditions, such as found in pack ice, these inertial motions tend to be highly damped. In order to cover the full range of expected ice conditions, ice drift forecasting must account for the physics of both low concentration and high concentration ice conditions.

## Current Research Activities

### ***Enhanced Iceberg and Sea Ice Drift Forecasting.***

The objectives of this project, conducted as an industry-sponsored joint industry program (JIP) under the Newfoundland R&D program, were to:

1. Define industry needs for iceberg and sea ice forecasts, including the most important factors and the associated time and space scales of interest
2. Benchmark existing capabilities of forecasting models that are currently available and being used, including strengths and limitations in terms of the industry needs
3. Determine the sensitivity and expected improvements in accuracy of ice drift models to new developments, and the expected benefits to current and future oil industry operations
4. Evaluate the benefits of including more real-time data into the ice drift forecast models.

Additionally the project scope included the development of a scope of work, execution plan, and cost estimates for possible future phases including:

5. Identification and evaluation of new and enhanced technologies and methods
6. Data analysis, development of improved models and software, and validation
7. Field demonstration and evaluation of models and equipment and technology integration and training.

At this stage, only the first phase has been completed with decisions on future phases pending.

***Specific Model Development.*** A model developed specifically for modestly deformed free (ice ridges remain within the mixed layer) drifting sea ice has

shown skill forecasting isolated ice floes in the Canadian Beaufort Sea.<sup>44</sup> The model is driven primarily by wind stress and the gradient of mean dynamic topography with a lesser contribution from the gradient of sea level pressure through the inverse barometer effect. The model, freely run for 6 days after initialization, was able to accurately replicate the drift of a large ice floe. It has also shown skill with other floes in the Canadian Beaufort, as well as for floes in other regions, as well.

When ice concentration reaches a level such that the ice drift becomes constrained, different models must be employed. One such model is the next generation Arctic Cap Nowcast/Forecast System (ACNFS). The ACNFS is an assimilative coupled sea ice and ocean model that nowcasts and forecasts conditions in all sea ice covered areas in the northern hemisphere poleward of 40°N.<sup>45</sup> The ACNFS is a high spatial resolution model (~3.5 km near the North Pole) with a 10-minute time step for the ice model component. ACNFS is forced with 3-hourly wind fields from the Navy Operational Global Atmospheric Prediction System. The ACNFS has shown skill at forecasting the ice drift, thickness, and concentration on broad scales throughout the Arctic.

Enhanced Verification and Interpretation of Freeze-Up Conditions for the Northeast Chukchi Shelf: field observations and process studies; freeze-up forecasts; and BOEM sea ice database enhancements. BOEM analysts and managers within the Alaska OCS Region seek more detailed spatiotemporal information pertaining to seasonal freeze-up conditions at specific planned drilling locations on the Alaska OCS. More reliable and extensive information is particularly needed during the late open water season when storm activity is anticipated, and during the seasonal freeze-up period when frazil ice formation and pack ice intrusions create environmental concern for safe operations. Additional information pertinent to understanding the physics of freeze-up and associated forces that greatly impact Arctic offshore operations is also needed. Study products will be used for NEPA (National Environmental Policy Act) analyses, including Environmental Impact Statements and Environmental Assessments, and related decision-making.

## Enhancement Opportunities

Long-term “climate” modeling should be the continued focus of non-industry researchers. These are

generally long timeline efforts that require a dedicated focus.

The (industry) high-priority item of extended season operations in ice places importance on developing reliable ice drift monitoring and forecasting capability on a local to regional scale.

## CONCLUSIONS AND RECOMMENDATIONS

A number of technology enhancement opportunities were identified in the previous section. A summary, ranked in order of priority, is provided in Table 5-2.

## REFERENCES

- 1 DF Dickins Associates Ltd. and OASIS Environmental. (2006). "North Slope Nearshore and Offshore Breakup Study." Report prepared for the Alaska Department of Environmental Conservation, Anchorage, 19 pp.
- 2 DF Dickins Associates Ltd., Vaudrey & Associates Inc., and SL Ross Environmental Research Limited. (2000). "Part II: A Review of Ice Conditions, Oil Behavior, and Monitoring" and "Appendix B: Weather and Ice Statistics." In Oil Spills in Ice Discussion Paper. Prepared for Alaska Clean Seas, Prudhoe Bay, AK.
- 3 Ibid.
- 4 Melling, H. and D. A. Riedel. (2004). "Draft and Movement of Pack Ice in the Beaufort Sea: A Time-Series Presentation April 1990 – August 1999." *Canadian Technical Report of Hydrography and Ocean Sciences* 238, Institute of Ocean Sciences, Sidney, BC, Canada.
- 5 Ibid.
- 6 Voelker, R., and F. Seibold. (1990). "Ice conditions along Alaskan marine transportation routes." Presented at ICETECH'90: Fourth International Conference on Ships and Marine Systems in Cold Regions, Calgary, AB, Canada.
- 7 Vaudrey, K. (1996). "Design Basis Ice Criteria for the Northstar Development." Prepared for BP Exploration (Alaska) Inc. by Vaudrey & Associates, San Luis Obispo, CA.
- 8 DF Dickins Associates Ltd. and OASIS Environmental. (2006). "North Slope Nearshore and Offshore Breakup Study." Report prepared for the Alaska Department of Environmental Conservation, Anchorage, 19 pp.
- 9 Hearon, G.E., D. Dickins, K. Morris, and K. Ambrosius. (2009). "Mapping Sea Ice Overflood Using Remote Sensing: Smith Bay to Camden Bay," OCS Study MMS 2009-017 under Contract No. MO6 PC 00034, sponsored by the U.S. Department of Interior, Minerals Management Service, Anchorage, AK.

Technology Enhancement Opportunity	Priority	Discussion
New U.S. controlled SAR satellite	High	SAR satellite prioritized to U.S. interests will ensure timely data access. Data would be used to support ice drift monitoring for extended season drilling and oil spill response.
Enhanced ice drift monitoring and forecasting	High	Directly supports extended season operations.
Near real-time monitoring of ice thickness	Medium	Improved airborne ice surveillance instrumentation for broad-area ice thickness measurement and identification of potentially difficult or hazardous ice.  Satellite technologies may also be utilized but this would likely require a much longer timeline.
Increased utilization of unmanned aerial systems (UAS)	Medium	Current FAA regulations are limiting use of UAS. While not directly a technology issue, limiting use of this technology is a disincentive for further advancement that would likely improve under more favorable regulations.
Continued advancement of marine ice radar	Medium	Continued research on ice type classification will lead to increased safety for ship transits and improve ice management efficiencies.
Climate modeling with focus on effects to ice cover	Medium	Important to help anticipate future ice conditions in the Arctic and assess impact on operations and engineering design in the next 40 years.
Advancements to unmanned submarine systems	Medium/ Low	Continued advancement of ice surveying technology for possible use for real-time monitoring of ice conditions.

**Table 5-2. Technology Enhancement Opportunities**

- 10 Mahoney, A.R., H. Eicken, A.G. Gaylor, and R. Gens. (2014). "Landfast sea ice extent in the Chukchi and Beaufort Seas: The annual cycle and decadal variability." *Cold Regions Science and Technology*, 103(0): 41-56.
- 11 Eicken, H. (2010). "Indigenous knowledge and sea ice science: What can we learn from indigenous ice users?" In: Krupnik, I., Aporta, C., Gearheard, S., Laidler, G.J., Kielsen Holm, L. (Eds.), *SIKU: Knowing our ice – Documenting Inuit sea ice knowledge and use*. Springer-Verlag, New York, pp. 357-376.
- 12 Nelson, R.K. (1969). *Hunters of the northern ice*. University of Chicago Press, Chicago.
- 13 Krupnik, I., Aporta, C., Gearheard, S., Kielsen Holm, L., and Laidler, G. (2010). *SIKU: Knowing our ice – Documenting Inuit sea ice knowledge and use*. Springer, New York.
- 14 Huntington, H. P., H. Brower Jr., and D. W. Norton. (2001). "The Barrow Symposium on Sea Ice, 2000: Evaluation of one means of exchanging information between subsistence whalers and scientists," *Arctic*, 54(2), 201-204.
- 15 George, J. C., H. P. Huntington, K. Brewster, H. Eicken, D. W. Norton, and R. Glenn. (2004). "Observations on shorefast ice dynamics in Arctic Alaska and the responses of the Iñupiat hunting community," *Arctic*, 57(4), 363-374.
- 16 Eicken, H., M. R. Kaufman, I. Krupnik, P. Pulsifer, L. Apangalook, P. Apangalook, W. Weyapuk Jr., and J. Leavitt. (2014). "A framework and database for community sea ice observations in a changing Arctic: An Alaskan prototype for multiple users," *Polar Geogr.*, 37(1), 5-27.
- 17 Arctic Research Consortium of the United States (ARCUS), "Sea Ice for Walrus Outlook (SIWO)," <http://www.arcus.org/search-program/siwo>.
- 18 Eicken, H., M. R. Kaufman, I. Krupnik, P. Pulsifer, L. Apangalook, P. Apangalook, W. Weyapuk Jr., and J. Leavitt. (2014). "A framework and database for community sea ice observations in a changing Arctic: An Alaskan prototype for multiple users," *Polar Geogr.*, 37(1), 5-27.
- 19 Stroeve, J. C., V. Kattsov, A. Barrett, M. Serreze, T. Pavlova, M. Holland, and W. N. Meier. (2012). "Trends in Arctic sea ice extent from CMIP5, CMIP3 and observations." *Geophysical Research Letters* 39, L16502, doi:10.1029/2012GL02676.
- 20 Intergovernmental Panel on Climate Change. (2013). "Climate Change 2013: The Physical Science Basis." Contribution of Working Group I to the Fifth Assessment Report of the Intergovernmental Panel on Climate Change [Stocker, T.F., D. Qin, G.-K. Plattner, M. Tignor, S.K. Allen, J. Boschung, A. Nauels, Y. Xia, V. Bex and P.M. Midgley (eds.)]. Cambridge University Press, Cambridge, United Kingdom and New York, NY, USA, 1535 pp.
- 21 Rigor, I. G. and J. M. Wallace. (2004). "Variations in the age of Arctic sea-ice and summer sea-ice extent." *Geophysical Research Letters* 31 (9):L09401, DOI: 10.1029/2004GL019492.
- 22 Kwok, R. and A. Rothrock. (2009). "Decline in Arctic sea ice thickness from submarine and ICESat records: 1958-2008." *Geophys. Res. Lett.*, volume 36, doi:10.1029/2009GL039035.
- 23 Johnston, M. and Haas, C. (2011). "Validating Helicopter-Based EM (HEM) Thicknesses over Very Thick Multi-Year Ice." Proc. 21st International Conference on Port and Ocean Engineering under Arctic Conditions (POAC). Montréal, Canada. POAC11-132, p. 11.
- 24 Johnston, M. (2014). "A decade of probing the depths of thick multi-year ice to measure its borehole strength," *Cold Regions Sci and Tech*, (99) 46–65.
- 25 Melling, H. (2002). "Sea ice of the northern Canadian Arctic Archipelago." *J. Geophys. Res.* 107:3181. doi:10.1029/2001JC001102.
- 26 Melling, H. (2014). "Multi-year sea ice of the Sverdrup Basin: New Observations 2009-2010" (2014 manuscript not yet published), Fisheries and Oceans Canada, Institute of Ocean Sciences, Sidney, BC, Canada. 53 pp.
- 27 Laxon, S. W., K. A. Giles, A. L. Ridout, D. J. Wingham, R. Willatt, R. Cullen, R. Kwok, A. Schweiger, J. Zhang, C. Haas, S. Hendricks, R. Krishfield, N. Kurtz, S. Farrell, and M. Davidson. (2013). "CryoSat-2 estimates of Arctic sea ice thickness and volume." doi:10.1002/grl.50193.
- 28 Melling, H., D.A. Riedel, and Z. Gedalof. (2005). "Trends in draft and extent of seasonal pack ice, Canadian Beaufort Sea." *Geophysical Research Letters*, Vol.32, L24501, 4p.
- 29 Melling, H., Francois, R., Myers, P.G., Perrie, W., Rochon, A., and Taylor, R.L. (2012). "The Arctic Ocean – A Canadian Perspective." *Climatic Change*. 115: 89-114. doi:10.1007/s10584-012-0576-4.
- 30 Brown, R. and P. Cote. (1992). "Interannual variability of landfast ice thickness in the Canadian High Arctic 1950-89." *Arctic*, Vol. 45, No. 3, pp. 273-284.
- 31 Dumas, J., Flato, G., and Brown, R. D. (2005). "Future projections of landfast ice thickness and duration in the Canadian Arctic," *Journal of Climate*, in press.
- 32 Nghiem, S.V., I.G. Rigor, D.K. Perovich, P. Clemente-Colon, J.W. Weatherly, and G. Neumann. (2007). "Rapid reduction of Arctic perennial sea ice," *Geophys. Res. Lett.*, 34, L19504, doi: 10.1029/2007GL031138.
- 33 Laxon, S. W., K. A. Giles, A. L. Ridout, D. J. Wingham, R. Willatt, R. Cullen, R. Kwok, A. Schweiger, J. Zhang, C. Haas, S. Hendricks, R. Krishfield, N. Kurtz, S. Farrell, and M. Davidson. (2013). "CryoSat-2 estimates of Arctic sea ice thickness and volume." doi:10.1002/grl.50193.
- 34 Kwok, R. and A. Rothrock. (2009). "Decline in Arctic sea ice thickness from submarine and ICESat records: 1958-2008." *Geophys. Res. Lett.*, volume 36, doi:10.1029/2009GL039035.
- 35 Clausi, D.A., Qin, K., Chowdhury, M.S., Yu, P., and Maillard, P. (2010) "MAGIC: MAP-Guided Ice Classification," *Canadian Journal of Remote Sensing*, 36(1), pp. S13-S25.
- 36 Reid, J. E., A. Pfaffling, and J. Vrbancich. (2006). "Airborne electromagnetic footprints in 1D earths," *Geophysics*, 71, G63–G72, doi:10.1190/1.2187756.
- 37 University of Alaska Fairbanks, Sea Ice Group at the Geophysical Institute, "Ice Observatories," <http://seaice.alaska.edu/gi/observatories>.
- 38 O'Connell, B. (2011). "Ice Hazard Radar," Proceedings of the 21st International Offshore and Polar Engineering Conference, Montréal, Canada.
- 39 Magnell, B., L. Ivanov, E. Siegel. (2010). "Measurements of Ice Parameters in the Beaufort Sea using the Nortek AWAC Acoustic Doppler Current Profiler," Proceedings Oceans 2010, doi: 10.1109/OCEANS.2010.5664016.
- 40 Wadhams, P, J. P. Wilkinson, and A. Kaletzkyy. (2004). "Sidescan Sonar Imagery of the Winter Marginal Ice Zone Obtained from an AUV." *J. Atmos. Oceanic Technol.*, 21, 1462–1470. doi: [http://dx.doi.org/10.1175/1520-0426\(2004\)021<1462:SSIOTW>2.0.CO;2](http://dx.doi.org/10.1175/1520-0426(2004)021<1462:SSIOTW>2.0.CO;2).
- 41 Ibid.
- 42 Melling, H. (2012). Sea-Ice Observation: Advances and Challenges Chapter 3. "In Arctic Climate Change – The ACSYS Decade and Beyond." Atmospheric and Oceanographic Sciences Library 43, doi 10.1007/978-94-007-2027-5\_3. Springer Science+Business Media B.V. 464 pp.
- 43 Ibid.
- 44 Blunt, J.D., D.A. Mitchell, D.G. Matskevitch, A.H. Younan, and J.M. Hamilton. (2012). "Tactical Sea Ice Drift Forecasting for Summer Operation Support in the Canadian Beaufort Sea," 2012 Arctic Technology Conference, Houston, USA, 3-5 December.
- 45 Posey, P.G., E.J. Metzger, A.J. Wallcraft, R.H. Preller, O.M. Smedstad, and M.W. Phelps. (2010). "Validation of the 1/12° Arctic Cap Nowcast/Forecast System (ANCFS)," NRL report NRL/MR/7320—10-9287, Stennis Space Center, Ms.

## Chapter 6

# Offshore Arctic Exploration and Development Technologies

### INTRODUCTION

The technologies involved in exploration and development of offshore oil and gas resources are some of the most advanced in the world. Likewise, the drilling and production facilities are among the largest and most complex civil structures in existence. Much research has gone into advancing the state of the art to the current level, and advancements continue as the industry turns its focus to more challenging resources. Over the decades, highly sophisticated methods have been developed for imaging subsurface geological structures and for ascertaining in advance of drilling the likely presence of hydrocarbons. The world's fastest supercomputers now process huge seismic datasets for months to render remarkably detailed three-dimensional images of rock formations miles below the earth's surface. Drilling has advanced to the point where a drill bit can be guided to a point 2 to 3 miles vertically below and 5 to 7 miles horizontally away from the drilling rig and hit within a meter of the target. Offshore platforms that are hundreds of meters tall with a base the size of the largest professional sports stadiums are routinely constructed, floated to, and installed in remote and harsh locations. From these platforms, as many as 60 to 80 wells may be drilled to tap reservoir rocks over an area of 10 miles or more in diameter. The topsides portions of these platforms that extend above the ocean surface can weigh up to 70,000 tons and carry a small village of skilled crew who drill wells and operate the complex hydrocarbon processing facilities. Many millions of barrels of oil a day are safely transported from these remote platforms to the world's markets through pipeline systems whose integrity is monitored via robotic probes that can detect early signs of corrosion or even small changes in the position of the pipe.

This chapter is focused on the specific segment of offshore technology that is aimed at the unique challenges of the Arctic offshore environment. The objectives of this chapter are to describe the current status of technology for offshore Arctic exploration and development (E&D) and identify technology enhancement opportunities with particular emphasis on the opportunities that would benefit from research by or collaboration with the Department of Energy or other federal and Alaskan state agencies. The technologies considered span the full spectrum of E&D activities from seismic data acquisition and exploration drilling to permanent production platforms, pipelines, and tankers. The E&D technology scope is focused on the U.S. Arctic offshore, which includes both Alaskan state waters (nearshore) and federal waters, also known as the OCS (Outer Continental Shelf). The full scope of technology areas considered is provided in Table 6-1. Note that well control and oil spill response technologies are not covered in this chapter. The reader should refer to Chapter 8 for a complete treatment of spill prevention and mitigation, including blowout preventers and capping stacks, and the state of the art for responding to oil spilled in an offshore Arctic environment.

The study focus is on technologies (1) driven by the challenges of the Arctic environment, (2) where substantial adaption of conventional technologies is needed to meet the challenges of the Arctic environment, or (3) where conventional technology is used in a new way. An example of (1) would be offshore platforms and pipelines that must be designed to resist loads from moving ice. An example of (2) would be storage and export where ice management may be needed to supplement tanker mooring in ice while oil is loaded on to them, and an example of (3) would be instrumentation and automation where new advances

	Technology	Detailed Examples within Technology Area	Unique Aspects Associated with Arctic Application of the Technology	Required for Exploration	Required for Development	Water Depth (Shallow, Deep, Both)	Importance for Global Arctic	Relevance/Impact for Near-Term U.S. Alaska Arctic Offshore
1	Arctic offshore geophysical data acquisition	Air gun alternatives; techniques for acquiring high-fidelity 3D seismic in and under ice; technology to reduce area impacted by acoustic signal	Interaction of ice with acquisition system	X		Both	X	H / M
2	Bottom-founded structures	Mobile concepts for varying water depths and seafloor conditions	Ice loads, platform relocation in ice, short installation window, permafrost soils, potential for interaction with drifting ice island	X		Shallow	X	H / H
	Development	Concepts to withstand loads from multi-year ice, ice islands, icebergs embedded in pack ice; concepts for maximum water depths	Ice loads, short installation window, permafrost soils, potential for interaction with drifting ice island		X	Shallow	X	H / M
3	Floating structures	Mooring and drilling riser systems allowing rapid disconnection and reconnection	Ice loads on moored vessel, disconnection, need for ice management, use as containment vessels	X		Both	X	H / H
	Development	Very high capacity mooring systems, mooring and drilling riser systems allowing rapid disconnection and reconnection, hull forms that optimize in-ice and open water performance	Extended season capability, ice loads on moored vessel, disconnection, need for ice management		X	Deep	X	L / L
4	Ice management	Remote sensing alternatives that improve ice typing reliability, thickness resolution, and mechanical properties (link with ice characterization); improved forecasting models; automatic detection of marine mammals; Common Operational Picture system for information management and display and fleet command/control	Continuous ice surveillance (overlaps with Chapter 5), reduction of ice loads on floating vessels, station-keeping in ice	X	X	Both	X	H / H
5	Emergency escape, evacuation, and rescue	Ice capable evacuation craft, and/or evacuation systems that avoid rubble ice around shallow water platforms	Ice interference with escape craft deployment and function requiring different systems for different water depths and ice conditions	X	X	Both	X	H / H
6	Winterization	Low energy technology and schemes for keeping spaces warm and preventing compartments with liquids from freezing; technology and schemes for mitigating explosion and fire consequences in enclosed spaces	Personnel safety and operations efficiency in extreme cold climate	X	X	Both	X	H / L
7	Low-temperature materials	Welding and connection methods for -50 to -60°C steels that can be practically and reliably executed for plate thicknesses up to 100 mm	Ambient winter temperatures that can fall below -55°C		X	Both	X	M / L
8	Automation and robotics	Integrated technologies that can make step change reductions in personnel (requires detailed understanding of current operation and maintenance practice)	Work under ice, reduction of personnel in harsh location		X	Both	X	M / M
9	Subsea production equipment	High reliability valves, chokes manifolds, control systems, condition monitoring	Can avoid ice interaction associated with surface-piercing structures, access and maintenance under ice, protection from ice impact in shallower water depths		X	Deep	X	H / L
10	Offtake and shipping	Independently acting icebreaking tankers, offloading connections and platform tethering facilities, ice management during offtake, ice rubble avoidance/clearing around platforms	Mooring/connection/station-keeping of tanker in moving ice, icebreaking vessels and support, escort in ice		X	Both	X	H / H
11	Offshore pipelines	Alternatives to welds for connecting large diameter pipe, deep excavation trenching equipment	Burial to large depth (e.g., >5m) below mudline for ice protection, short installation window, pipe lay in mobile sea ice		X	Both	X	H / H
12	Technologies for dealing with associated gas		Potentially difficult to inject		X	Both	X	M / L

**Table 6-1. Scope of Exploration and Development Technologies Considered in the Study**

made for other industries may be applicable to Arctic development. Not considered in the study are technologies whose use in the Arctic would be essentially identical to that in temperate environments (e.g., down-hole drilling components) because their advancement will take place independent of Arctic development.

The predominantly shallow Alaskan OCS water depth coupled with the anticipated pace of hydrocarbon development to the year 2065 eliminated any need to consider new development technologies for water depths beyond the reach of bottom-founded production platforms. Hence, Arctic development technologies needed for deeper water, such as the capability to conduct year-round floating drilling of development wells or year-round floating oil production facilities, were not considered. The E&D technologies considered include:

- Exploration data acquisition
- Exploration drilling platforms
- Ice management
- Production platforms
- Personnel safety
- Offshore pipelines and subsea installations
- Offtake and tankering.

This chapter considers the implications of individual E&D technologies on the multiple dimensions of prudent development. Prudent development depends on the ability to select an appropriate combination of technologies for both safety and cost efficiency. Many technologies by their nature are important contributors to overall safety of offshore operations. Some technologies, like escape and evacuation craft, are critical for personnel safety. Well control systems, pipelines, and tankers all provide direct barriers to hydrocarbon releases and therefore are important technologies for sound environmental performance. Many technologies, especially ice-capable drilling rigs and production platforms and Arctic pipelines, represent significant cost premium components for Arctic exploration and development. Finally, although the study is focused on offshore technology, some of the technologies have potential to affect local inhabitants, especially if they involve marine operations within

areas used for subsistence hunting or fishing or the utilization of onshore infrastructure.

In the sections that follow, each of the key E&D technology areas are discussed within the following framework:

- Role the technology plays in Arctic exploration and/or development (global and Alaska OCS specific)
- Unique technical challenges associated with application of the technology in an Arctic environment
- Brief history of the technology's development and use in Arctic conditions
- Current state of the technology (e.g., maturity of design and operating standards, extent of industry experience, performance record, key enhancements that have improved performance, and current capability limitations)
- Prudent development context considering all dimensions
- Key recent and ongoing research activities by industry, academia, and/or governments
- Prioritized technology/capability enhancement opportunities that could facilitate prudent development.

Overall recommendations regarding research opportunities and priorities are provided at the end of the chapter. Technology enhancement opportunities were not limited to hardware improvements, but also consider people, capability, and even operational restrictions. The primary conclusion is that technology to accomplish prudent offshore exploration and development for the U.S. waters within this study scope already exist as a result of decades of practice and experience. Nonetheless, there are important research opportunities—especially in the realm of better understanding potential environmental impacts of E&D operations and field demonstration trials for recent technology enhancements—that could be very instrumental in advancing prudent development.

The state of E&D technology is not static. There will always be opportunity for technology enhancement, as the industry continuously strives for better safety, environmental protection, and cost effectiveness, or to extend safe operations into more challenging ice environments. While these continuous,

incremental improvements taken collectively over time will improve performance, no single technology improvement alone could be expected to make a material difference in the ability to prudently explore and develop the U.S. Arctic offshore.

The highest priority E&D technologies are those needed to extend the drilling season length in ice while meeting the strict operational reliability requirements of hydrocarbon drilling and not creating unacceptable impacts on ice-dependent species or subsistence hunting. At the core of such capability is ice management, which comprises a variety of component technologies that collectively support station-keeping in mobile pack ice. The priority is deemed high due to the critical economic importance of extending the useful season for exploration drilling.

## **EXPLORATION DATA ACQUISITION IN ARCTIC WATERS**

Acquisition of seismic data has been conducted in the various Arctic regions for at least five decades. Early offshore efforts included acquisition of 2D (two dimensional) seismic profiles using both land acquisition equipment operated on the ice during the winter and towed marine streamer during the summer. Before 2009, towed 2D marine streamer data were typically acquired during the open water seasons where the vessels and equipment could operate in areas where the ice was not present, or in some cases operating in the open leads of the ice pack. Since 2009, and with the introduction of advanced technologies and techniques, a number of 2D seismic operations have been conducted in pack ice, including up to 90% coverage of mixed first-year and second-year, with traces of multi-year ice coverage.

Since the introduction of 3D (three dimensional) seismic technology and methodologies in the 1980s, there has been an exponential growth in exploration data acquisition, including 4D or time-lapsed seismic. These technologies have been recognized as some of the most significant developments for reducing geological risk and improving drilling and production success in the oil and gas industry. With the exception of conventional 2D and 3D seismic techniques, many of these advanced seismic technologies and methodologies have not been adapted for utilization in the Arctic. To date, the need for advanced exploration seismic data acquisition in the Arctic has been moderated by

the challenging economics in the more ice-bound areas of the Arctic, and the prioritization of more attractive opportunities in other regions with significant open water seasons or no ice.

Figure 6-1 shows acquisition technology and methodologies as they are applied currently in the various phases of the E&D lifecycle. The actual choice of seismic acquisition system (land/marine towed streamer/ocean bottom system) and the specific acquisition methodology/geometry can vary based on the resolution of the information required, as well as the area of operation.

The value as well as the cost of the information/knowledge derived from each of these technologies and methodologies generally increase later into the E&D lifecycle. Regional 2D seismic data can provide information relative to general geologic trends and structures, basin architecture and extent, source rock potential, and potential hydrocarbon migration pathways, whereas Exploration 2D grid surveys tend to be more focused on evaluating potential over lease blocks, including early prospect identification and targeting for additional studies. Three-dimensional surveys provide enhanced imaging quality of complex geologic structures and stratigraphy and reduced uncertainty compared to 2D data alone. As noted in Figure 6-1, there are a number of variations of specific 3D technologies and methodologies that can be applied currently, covering a significant range of the E&D lifecycle. Specific choice of 3D technology and methodology to be deployed can be based on the required resolution of geologic complexity (subsalt/stratigraphy/complex faulting) and/or the area and project timing and logistics (multiuse areas/environmental requirements/cultural constraints/existing wells and platforms). Time lapse, or 4D seismic, are 3D surveys that are repeated in the same location over specific time intervals during the production phase of the E&D lifecycle and provide information relating to changes in the reservoir resulting from production, which allows for planning of infill drilling or other interventions to improve overall hydrocarbon recovery rates and ultimately overall field economics.

### **Unique Aspects of Application in an Arctic Environment**

Acquisition of marine seismic data in many areas of the Arctic is challenged by the extreme operating

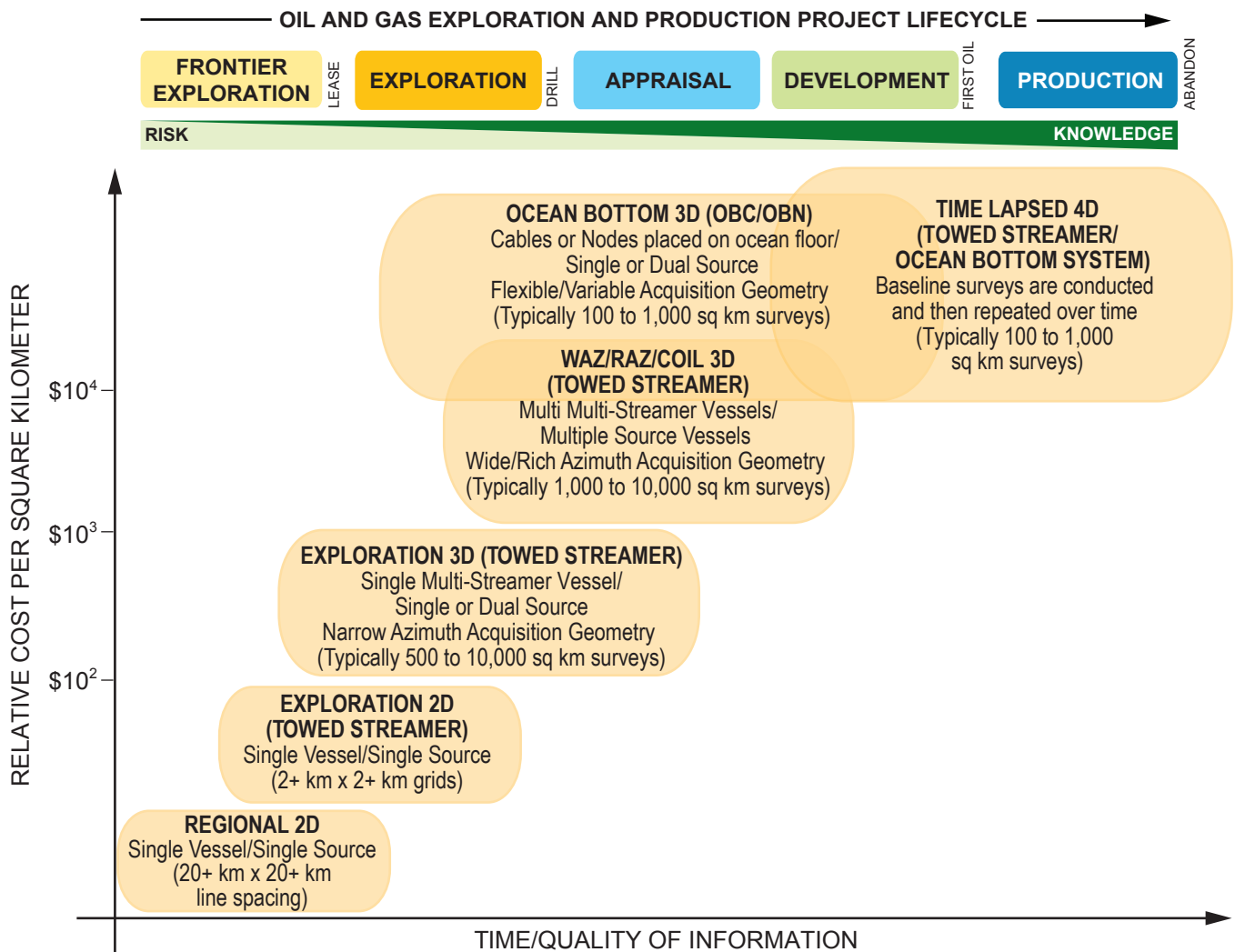

Source: ION Geophysical.

**Figure 6-1.** Relative Costs and Acquisition Times for Various Levels of Seismic Data Acquisition

conditions and local environmental sensitivities. Operating conditions, including limited or no daylight, high winds and seas, extreme cold temperatures, and presence of ice, all shorten the time window for conventional seismic operations in Arctic environments. The presence of ice either requires conventional towed systems to avoid the ice or new ways to work in and around the ice with icebreaker support.

Conventional towed seismic operations use vessels and equipment that are not designed to operate in ice-covered conditions and that can be severely damaged by contact with ice. With careful planning, the use of conventional seismic vessels and equipment is not precluded, but operating windows are limited to strictly open water conditions, and the risks of

delay or cancellation due to inter-year ice variability can severely limit the ability to acquire the requisite data for any given season. Even with the careful selection of maritime vessels of an appropriate ice class, there is still potential for damage to in-water acquisition equipment, and, in the case of icebreaking, unwanted noise can be introduced into the data. It is important to note that delays in acquiring the seismic data can have a significant effect on the overall timeline for development of any project. A number of these aspects are described in greater detail in Macdougall et al.<sup>1</sup>

Beyond the aspects described above, there are other unique challenges in the Arctic. The remoteness of Arctic locations also presents many logistical issues

for project support, and the protection of customs and traditional lifestyles of the indigenous population, including their dependence on marine wildlife, may further limit seismic activities, both in terms of timing and type of equipment used.

With regard to the acquisition of seismic data in the U.S. Arctic seas, much of the Chukchi Sea has sufficient, dependable open water seasons to conduct conventional seismic operations. Ice conditions in the Beaufort tend to be more of a factor for seismic programs as the open water season is typically shorter and more varied year on year.

## **History of Technology Development and Application in Arctic Conditions**

Seismic acquisition has been an ongoing effort in the Arctic for many years, as described by the U.S. Geological Survey.<sup>2</sup> To date, significant offshore data acquisition effort has been conducted on the fringes of the Arctic using conventional technologies and methodologies applied during open water periods. Arctic seismic surveys have generally been split between those conducted by the oil and gas industry in search of resources and non-oil and gas related acquisition activity conducted by government and academic research groups and consortiums. The latter projects used private and government assets. The majority of these regional studies were focused on developing knowledge and understanding of macro geologic structure and history, and in some cases to help develop estimates of the potential for hydrocarbon resources. The broad regional surveys were well planned and produced significant learnings. However, they were sparse, covered large aerial extents, were very expensive, generally nonrepeatable, and provided insufficient focus and resolution for advanced E&D requirements.

Early exploration seismic work was conducted in the 1970s in the Sverdrup Basin of Northern Canada utilizing land seismic technology placed on top of stable nearshore ice. Such on-ice methods, which are limited to conditions of stable or landfast ice, were utilized in Alaska in the 1990s to map potential nearshore prospects. Traditional marine 2D streamer data were collected offshore in the U.S. and Canadian Beaufort Sea throughout the 1980s and early 1990s. Beginning in 2006, extensive regional 2D streamer and some ocean bottom cable (OBC) seismic data

were acquired throughout the Beaufort and Chukchi Sea, using primarily conventional acquisition systems and methods. There were greater than 50,000 linear kilometers of modern 2D exploration-grade seismic data acquired over a 4-year period. Since 2009, there have been three exploration-grade 3D streamer surveys and at least two smaller 3D OBC projects conducted over specific Arctic lease blocks. These projects produced greater than 8,000 square kilometers of seismic data. In Eastern Canada, Russia, Norway, and Greenland, there have been similar efforts to acquire exploration-grade seismic data north of the Arctic Circle utilizing mostly conventional technology, taking advantage of the traditional summer open water seasons. In 2014, there was no activity in the North American Arctic, while there were eight 3D surveys ongoing in the Barents and Kara Seas.

## **Current State of the Technology**

Current technology is based on an array of streamers containing receivers (hydrophones) and sources (airguns) towed behind an acquisition vessel. Conventional towed seismic streamer configurations utilize surface-referenced floats for maintaining proper positioning of the streamers and sources. These floats may have GPS or acoustic equipment attached for maintaining positional accuracy during the survey. The presence of sea ice poses particular hazards for surface-referenced seismic floats, streamers, wires, lead-ins, and umbilicals as they transition from the vessel and into the water column. Contact between the sea ice and the vessel(s), and/or any of the seismic devices or cables, can cause equipment damage that could lead to the failure of the acquisition project. Given this risk and limited technology to overcome it, exploration data acquisition using conventional open water methods has generally been conducted in “ice free” conditions. Some of the more recent Arctic surveys have used special mitigation provisions, including, but not limited to, ice classing of vessels (seismic, chase, etc.), emergency preparedness plans, and ice monitoring and management, in an effort to reduce any potential risk from the sea ice.

Seismic data acquisition in the Arctic can be defined by the operational requirement of the mission relative to the sea ice. Three specific mission types are defined as “ice free,” “ice avoidance,” or “under ice.” “Ice free” refers to the use of conventional seismic

equipment and technology deployed in an operating environment where ice is not considered a hazard.

“Ice avoidance” refers to the use of vessels and seismic equipment deployed in an environment that may require the operation to be carried out proximal to broken and/or pack ice, and/or in waters that may contain scattered broken ice, which in turn may require the vessel to plan operations so as to avoid the working in ice altogether and/or to deviate from its prescribed course in an effort to avoid contact with the ice. Vessels and equipment need to be selected or adapted for these operating conditions. Chase or ice-management vessels may be used as well.

“Under ice” refers to the use of conventional and/or nonconventional seismic equipment and technology deployed in ice-covered waters with the expectation that the vessel(s) and in-water seismic equipment will likely come in contact with the ice during the course of normal operations.

The majority of exploration data acquisition to date has been conducted as “ice free,” and has used conventional seismic equipment and methods. These are subject to the limits of the vessel and equipment utilized and the ice extent and conditions over the specific project area at the planned time of the operation. While these types of surveys are planned to take maximum advantage of open water conditions, the underlying assumption is that if there is an unusual or bad ice year, the opportunity to acquire data for any given specific project may be severely compromised or lost.

Recent examples of “ice free” surveys would include:

- 2D Regional programs in the U.S. Chukchi Sea (2006 and 2009) conducted by ION Geophysical and TGS utilizing a towed marine streamer and conventional seismic airgun array.
- 2D Regional programs in the U.S. and Canadian Beaufort Sea (2006-2010) conducted by ION Geophysical utilizing a towed marine streamer and conventional seismic airgun array.
- 3D Exploration programs in the Canadian Beaufort Sea for Imperial/ExxonMobil (2008) conducted by WesternGeco; BP (2009), conducted by CGG; and Chevron (2012), conducted by WesternGeco, utilizing conventional 3D marine towed streamer arrays and conventional seismic airgun arrays.

- 2D Regional programs in the Russian Arctic (Laptev, Eastern Siberian, and Chukchi Seas), conducted by ION Geophysical (2010-2012), utilizing a towed marine streamer and conventional seismic airgun array.
- 2D Exploration programs in the Russian Arctic (Laptev, Eastern Siberian, Chukchi, and Kara Seas) conducted by Russian geophysical companies (DMNG, SMNG, MAGE) on behalf of Russian E&D companies (Rosneft, Gazprom, etc.).

“Ice avoidance” surveys have been much more limited in extent and scope. These surveys may utilize conventional seismic vessels with some ice class and/or weatherization, in-water seismic equipment adapted or configured to help mitigate catastrophic failure in the event there is incidental contact with sea ice, and with enhanced onboard ice management systems, personnel, and support. The goal is to strategically forecast ice movements and tactically locate all proximal ice to ultimately avoid any contact between the vessel and in-water seismic equipment and the ice.

Recent examples of “ice avoidance” surveys would include:

- Shell Chukchi Sea (2006) and Beaufort Sea (2007) 3D surveys, conducted by WesternGeco
- Statoil Chukchi Sea (2010) 3D survey, conducted by Fugro-Geoteam<sup>3</sup>
- Exploration 3D in Western Greenland (2012), for Shell, conducted by Polarcus, utilizing two conventional multi-streamer/multi-source seismic vessels operating in tandem, with enhanced onboard ice forecasting and management tools and personnel
- 2D Regional program in Labrador (2013), conducted by ION Geophysical utilizing a conventional 2D towed streamer and airgun source, with icebreaker escort.

For the latter two projects, the key was avoidance of the many icebergs of various large and small sizes that were present in the prospect area.

“Under ice” surveys conducted by the E&D industry for exploration purposes have been very few given the risks discussed earlier. However, there have been technologies and methodologies developed to reduce the ice contact risks with the in-water seismic equipment

and have resulted in the successful execution of several 2D data acquisition projects in ice-covered regimes. These developments have followed two approaches. One is a method-based approach that has used a conventional 2D seismic vessel with some ice-class rating and equipment deployed in such a manner that reduces the surface footprint of the in-water seismic equipment. The second is a technology-based approach that has focused on development of new equipment that allows for the complete elimination of any surface footprint of the in-water seismic equipment that trails behind the seismic vessel, as described in Rice et al.<sup>4</sup> To date, these approaches have been applied to both conventional 2D seismic vessels with some ice-class rating, as well as to an Arctic-classed icebreaker converted to tow an exploration-grade seismic streamer and source array.

Recent examples of “under ice” surveys include:

- 2D Regional seismic projects, Northeast Greenland (2009-2011), conducted by ION Geophysical, using a conventional ice-classed seismic vessel outfitted

with the under-ice technology and escorted by an icebreaker (see Figure 6-2).

- 2D Exploration seismic projects, Northeast Greenland (2010-2012), conducted by TGS, using a conventional ice-classed seismic vessel, escorted by an icebreaker.
- 2D Regional seismic project, Russian High Arctic UNCLOS project (2011), with ION Geophysical, using a converted Arctic-classed icebreaker with under-ice seismic equipment, escorted by a nuclear icebreaker (see Figure 6-3).
- 2D Regional seismic project, Russian Eastern Siberian and Chukchi Seas, as well the U.S. Beaufort and Chukchi Seas (2012), conducted by ION Geophysical, utilizing a conventional ice-classed seismic vessel, partially equipped with under-ice technology, and escorted by an icebreaker.

There have been a number of additional “under ice” surveys conducted since the 1990s, but the majority were academic/government-based and utilized a



Photo: ION Geophysical.

**Figure 6-2.** Icebreaker Oden Leading Seismic Vessel MV Geo Explorer



Photo: ION Geophysical.

**Figure 6-3.** Nuclear Icebreaker Rossiya Leading Seismic Icebreaker Federov (Seismic Vessel)

very short streamer and a very small source, so the applicability of the data acquired for E&D purposes is limited.

## Prudent Development Context

Exploration data acquisition in the Arctic has implications for several of the prudent development dimensions. It is important to conduct a complete and quality seismic survey prior to drilling an exploration well because the seismic data play a key role in the design of a safe well program. Information derived from seismic data is used to design the drilling fluid and well casing strings, which are primary barriers for well control. With regard to potential direct environmental impacts, the primary consideration is impact of sound from the seismic operation on nearby marine organisms, especially marine mammals. Detailed examples of this are discussed in Funk et al.<sup>5</sup> Other prudent development considerations for seismic operations in the Arctic offshore include (1) increased cost of operations in ice due to the use of ice-classed vessels and special equipment and often limited time windows for acquisition, (2) potential safety exposure for vessel crew in the harsh environment, and (3) the potential for schedule impacts due to more complex permitting processes.

## Recent and Ongoing Research

Given the difficulty that surface ice conditions cause in marine seismic acquisition, many alternative technologies have been proposed to address the issue, mostly related to keeping above or below the ice.

An alternative to towed marine streamer would be the use of ocean bottom cable (OBC) or ocean bottom nodes (OBN). These methods rely on deploying seismic cable, autonomous recording nodes, or a hybrid solution of autonomous nodes mounted on a cable. Because of the time and effort required to place and retrieve sensors from the seafloor, these solutions are far less efficient than moving streamer surveys, but they can be the only feasible solution when surface seismic is not viable.

Several seismic contractors are working to modify surface streamer equipment to work below the ice, using fully submerged equipment. Buoyancy for this type of equipment is typically mated to the seismic gear to provide near neutral buoyancy with con-

trol surfaces to provide trim control. However, this approach can be problematic because GPS cannot be used in the positioning of the seismic receivers. The alternative is to use a fully submerged acoustic solution.

To reduce the effects of seismic acoustic pulses on marine mammals, alternative sources have been developed that either spread the acoustic amplitude over a longer time period (marine vibroseis) or limit the frequencies that are generated by airguns (e-guns). Both technologies reduce the decibel level of the acoustic energy introduced into the water column and therefore pose less of a concern than standard airguns to most marine mammal species. These technologies, which could conceptually be used in ice-obstructed waters, require further improvements to address application issues.

## Potential Technology Enhancements

This study identified the following technology enhancements that would support safe and responsible, cost-effective seismic data acquisition in the Arctic:

- Alternative seismic sources designed to reduce cumulative ocean noise effects as well as mitigate potential exposure of marine mammals and endangered species that may be sensitive to effects of conventional seismic sources (e.g., improvements to alternative sources currently under development such as marine vibroseis or other). This need is not Arctic-specific, as the most sensitive species, whales, inhabit most of the world's oceans.
- Improved subsurface handling and towing equipment and capabilities to allow for the safe and uninterrupted collection of towed seismic data in and under ice-obstructed waters.
- Improved battery/power technology to extend the useful cycle time for ocean-bottom based seismic sensor arrays.
- Improved subsea acoustic transmission capabilities for command/control/quality control and real time collection of seismic information from ocean bottom-based seismic sensors.

Because seismic acquisition is a form of marine operations in ice, the study identified technology enhancement opportunities that are common to

other marine operations such as ice management for station-keeping. Those include:

- Improved high bandwidth, high latitude communication systems
- Improved ice imaging, modeling, and forecasting systems and database capability for conducting seismic data acquisition activities in the presence of sea ice.

Finally, enhancements to both submarine and aerial unmanned vehicle platforms have potential to improve seismic data acquisition in Arctic environments.

- Autonomous underwater vehicles (AUVs) have been in Arctic use for many years now, mainly for hydrographic use. The potential to use submarines to pull streamer cables has been discussed in the literature for over 20 years but is still viewed as impractical or cost prohibitive.
- Unmanned aerial vehicles (UAVs) have been discussed for use in ice scouting and marine mammal observation. They can be deployed from a surface ship, transmit visual, infrared, or radar images in real time, and then be retrieved onboard. Such aerial surveillance capability can be extremely useful during times of cloud cover when satellite imagery may be limited. While UAV technology has reached a fairly mature state, it has not yet been used extensively in the Arctic. Hence this opportunity would be focused on permitting of UAV use in the Arctic versus creating new technology.

## **EXPLORATION DRILLING PLATFORMS**

Offshore Arctic oil and gas exploration began in the Alaskan and Canadian Beaufort Sea almost 50 years ago beginning with the construction of artificial gravel islands in shallow Alaskan state waters during the late 1960s. Similar activity took place in the shallow waters of the MacKenzie River delta in the Canadian Beaufort Sea in the early 1970s. Both the U.S. and Canadian Arctic regions are considered herein due to their geographical proximity, the close similarity in the Arctic environments, and the commonality of the operating companies.

This early exploration activity was responsible for significant advances in icebreaker design and the development of methods for conducting drilling-related marine operations in ice such as ice management to support station-keeping of a moored drill rig. All of the icebreaking supply vessels designed and constructed for the Beaufort Sea in the 1980s are still in active service.

Exploration activity in the farther offshore areas of the Alaskan Outer Continental Shelf regions began in the 1980s and continues to the present.<sup>6</sup> Figure 6-4 shows the Alaskan offshore areas together with a tally of exploration wells that have been drilled therein.

Exploration wells have moved from shallow water to increasingly deeper water depths, and the technologies, using both fixed and floating structures, are described in Figure 6-5.

The original period of offshore Arctic exploration in Alaska and Canada saw rapid advancement in technology and experience. It was a period of investment and innovation with respect to the Arctic sciences, Arctic design and construction, and other field activities. These can be summarized as follows:

- Major investment in the ice sciences through a large number of industry and government sponsored projects.
- Large-scale ice imagery using synthetic aperture radar from fixed wing aircraft—prior to the widespread commercial access to satellite instruments.
- The use of ice as an engineering material for floating roads, airstrips, drilling pads, and other structures.
- Knowledge of ice loads on bottom-founded and floating structures through full-scale field measurements. The observations and data acquisition from the *Molikpaq* and the *Kulluk*, in particular, remain the foundation for today's engineering parameters for offshore Arctic operations.
- Ice management to protect station-keeping vessels and operations in ice during different seasons and ice conditions.
- Innovation in icebreaker design and construction. All of the vessels constructed for the Beaufort Sea are working today and have provided direction for today's ongoing technology developments for ice-class vessels.

**Department of the Interior  
Outer Continental Shelf Oil and Gas Strategy**

- Executed Leases
- Deferral Area
- Low Resource Potential and/or Low Support for Potential New Leasing
- Leasing Consideration 2012-2017 Program
- OCS Planning Area Boundary

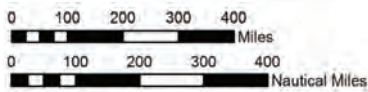

GCS NAD 83  
Alaska Albers Projection  
December 2013

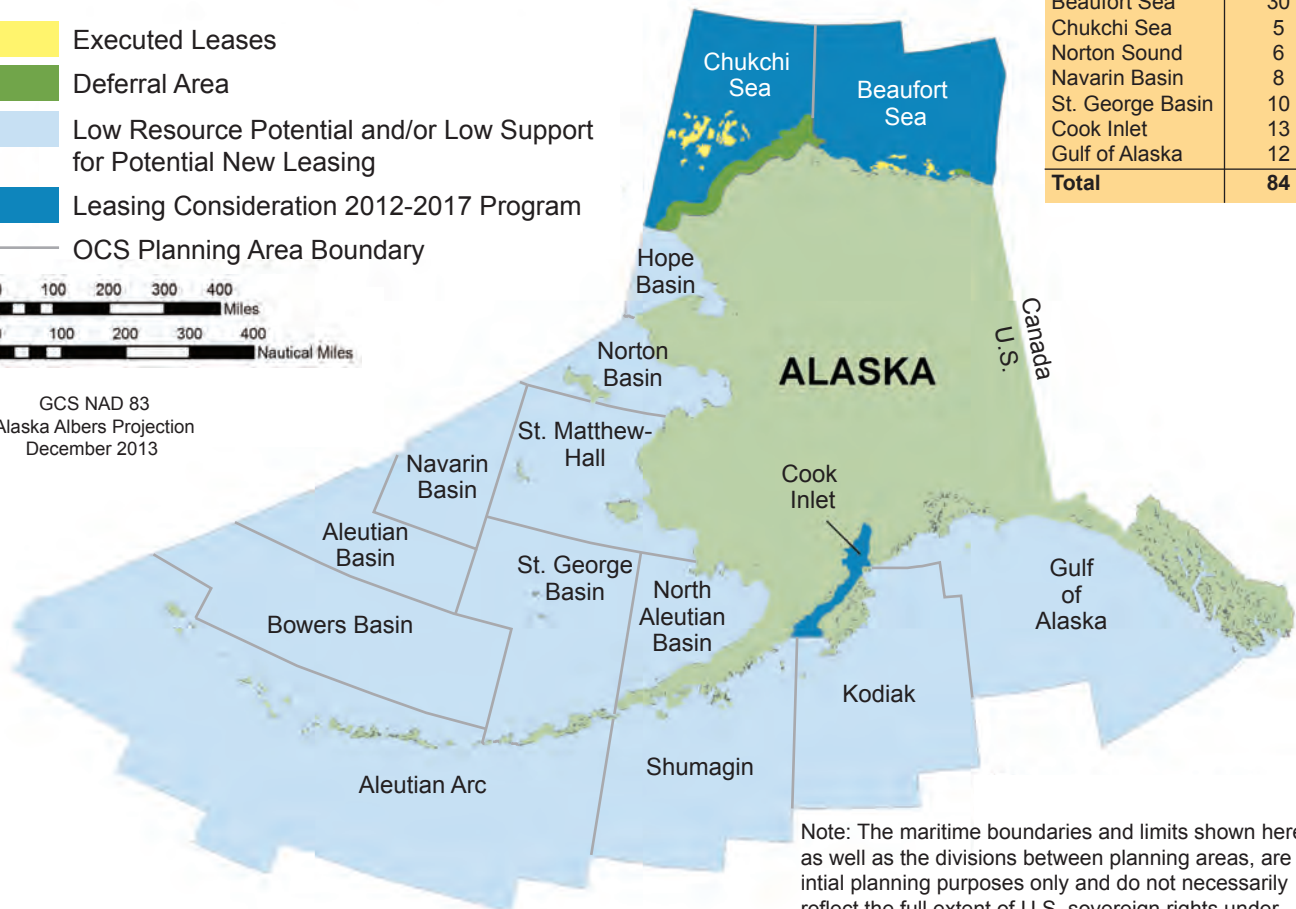

AREA	WELLS DRILLED
Beaufort Sea	30
Chukchi Sea	5
Norton Sound	6
Navarin Basin	8
St. George Basin	10
Cook Inlet	13
Gulf of Alaska	12
<b>Total</b>	<b>84</b>

Note: The maritime boundaries and limits shown hereon, as well as the divisions between planning areas, are for initial planning purposes only and do not necessarily reflect the full extent of U.S. sovereign rights under international and domestic law.

Source: Bureau of Ocean Energy Management.

**Figure 6-4.** Alaska Outer Continental Shelf – Exploration Wells Drilled

- The design and construction of bottom-founded structures for year-round deployment in a range of ice conditions from polar ice, seasonal first-year ice, and regions with iceberg incursions.

### Unique Aspects of Application in an Arctic Environment

Drilling of exploration wells in the presence of mobile Arctic ice presents unique challenges compared to temperate regions. The maximum forces or loads exerted on platforms by sea ice generally exceed those caused by wind and waves. As a consequence, bottom-founded exploration rigs must be capable of withstanding significant loads in the event of ice interaction, or conversely, careful monitoring and operational measures must be taken to ensure that

ice does not interact with the rig. In the case of floating platforms, ice loads can easily exceed the capacity of the rig’s mooring system. Hence, rigorous procedures are required to monitor and manage ice that approaches the drill rig. The potential for unmanageable ice to cause an overload situation also means that floating rigs must have the ability to safely and quickly disconnect from the well/mooring system in order to avoid being pushed off station in an uncontrolled manner.

The technical challenges in the offshore Arctic are primarily associated with ice monitoring and data acquisition, ice-class vessels, and station-keeping. The Arctic marine environment is dominated by the influence of sea ice, which covers Alaskan Arctic OCS waters for the majority of the year. Open water

## ARCTIC EXPLORATION DRILLING SYSTEMS

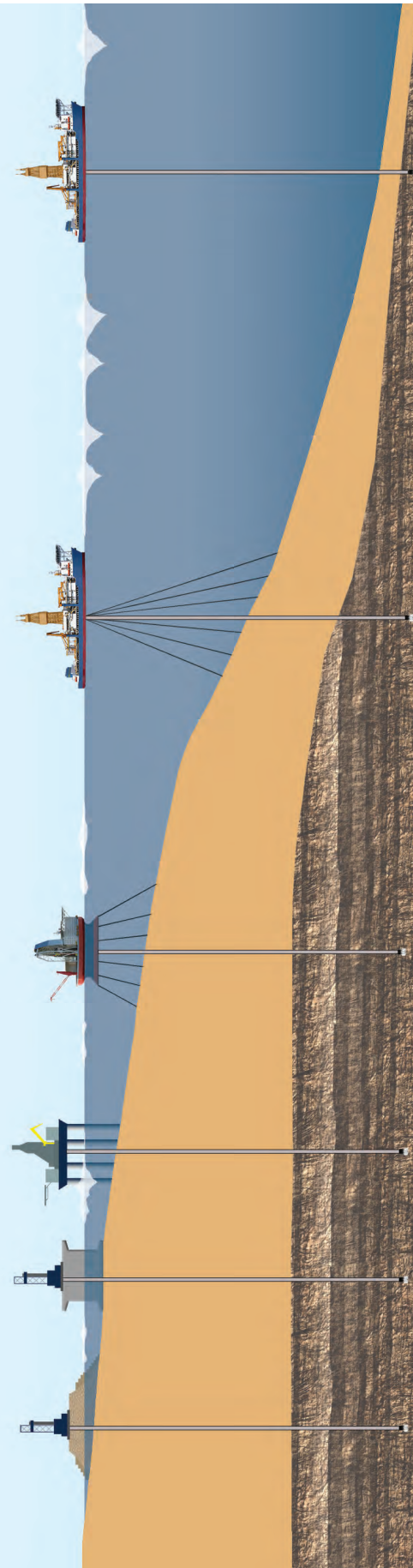
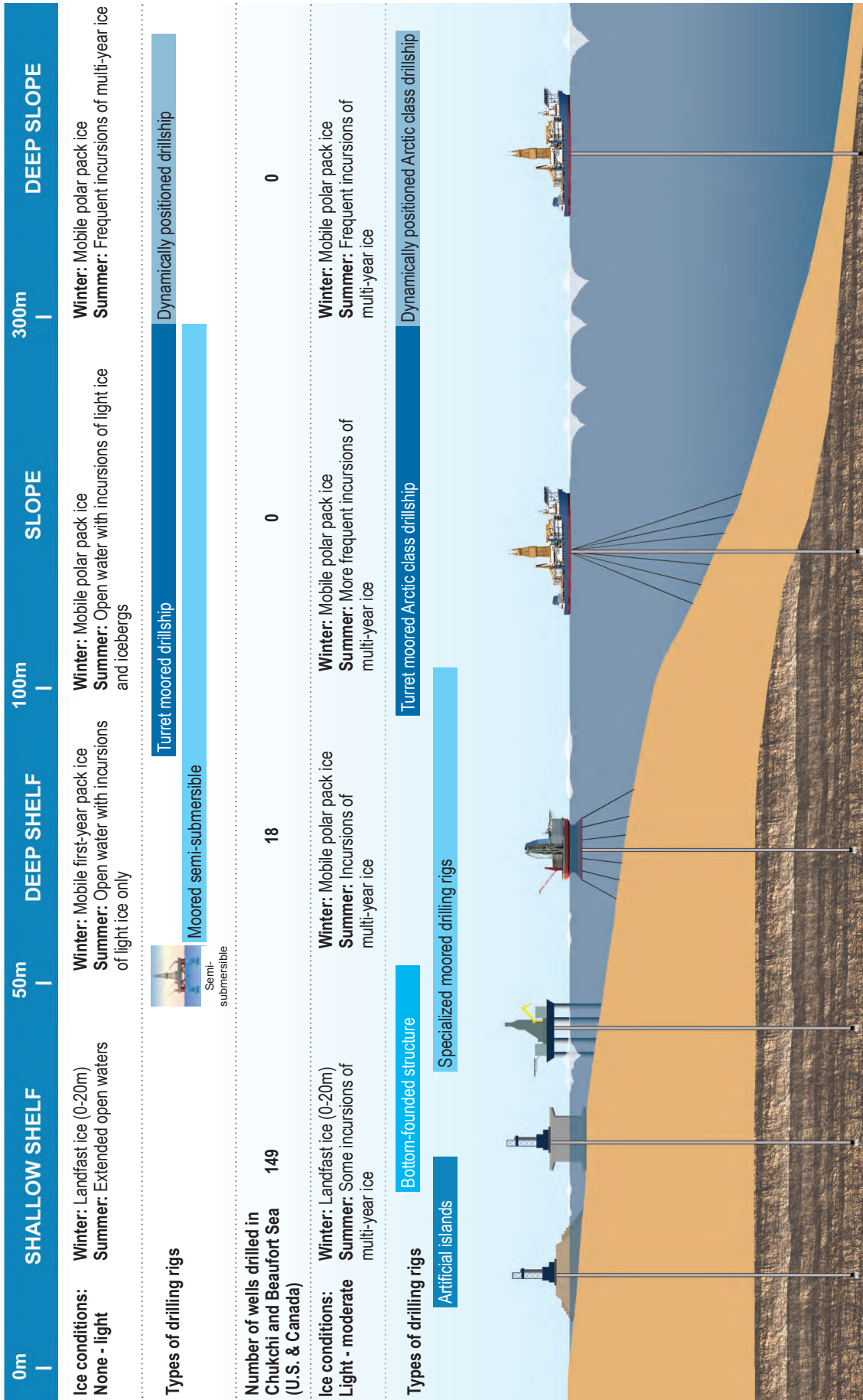

Source: BP.

**Figure 6-5.** Water Depth Progression of Exploration Drilling Technology for the Chukchi and Beaufort Seas

conditions occur in the late summer and early fall, which permits non-ice-class vessels to operate for limited periods of time. Even during these periods of open water, the polar ice pack still lies relatively close to the north and can be carried by winds over a period of a few days into the open water areas. Hence ice in the region requires constant monitoring. Ice class vessels are an important component to ensure that all vessels can safely enter and exit the Arctic, to provide the capability to remain in the theater during periods of ice incursions, and to provide the capability to extend the operating season beyond the open water period. Floating drilling vessels in the relatively shallow waters of the Alaska OCS will require a mooring system to maintain their position on station. The majority of modern drillships use dynamic positioning for station-keeping in deeper waters. There are only a few turret moored drillships that can operate in conditions that may include sea ice incursions, and even those cannot operate in significant concentrations of ice with large floes.

## History of Technology Development and Application in Arctic Conditions

This history section is divided between discussion of bottom-founded structures and floating drilling rigs. Bottom-founded structures rest on the seafloor and derive their resistance to ice and wave forces through the foundation resistance from the seafloor. Examples would include man-made gravel islands, pile-supported steel jacket type structures, and large steel or concrete caissons (typically called gravity-based structures [GBS] because their large mass gives them on-bottom stability).

Floating drilling rigs derive their resistance to wind, wave, and ice loads through either a mooring system or by “dynamic positioning,” or DP, which uses computer controlled thrusters to maintain station over a fixed position on the seafloor. Mooring systems can be either “spread moored,” which maintains the vessel in a fixed heading or, for some drillships, can be turret moored. Turret mooring allows the vessel to rotate and to be orientated into the prevailing environmental conditions. DP vessels usually cannot resist as much wave or ice loading as vessels that are moored to the seafloor, but they may have a more rapid disconnect capability.

## Design Codes and Standards

Internationally accepted Arctic codes and standards are in place (or in a few cases being developed) for design and operation of platforms and vessels. The most relevant codes and standards include the following:

- The International Maritime Organization (IMO) MODU Code governs the construction and equipment of mobile offshore drilling units (MODUs).
- The IMO Polar Code is in the process of being approved and is expected to come into force in early 2017. This covers all shipping in polar waters, but it is not specific to Arctic drilling rigs.
- For drilling rigs, Class Rules are the basic certification governing design and deployment of an Arctic class drilling rig. An Arctic notation will be required for conditions with low temperatures and/or sea ice. The International Association of Classification Societies (IACS) has recently published harmonized rules for Polar Class vessels.
- The Oil Companies International Marine Forum document *Offshore Vessel Operations in Ice and/or Severe Sub-Zero Temperatures* provides guidance and cross comparison of class rules.
- International Organization for Standardization (ISO) has published Standard 19906 for Arctic Offshore Structures—both fixed and floating.<sup>7</sup> This standard excludes MODUs (which are covered by ISO 19905 for non-Arctic conditions), but it does state that the procedures for assessing ice actions contained in the Standard are applicable to MODUs.
- ISO TC67/SC8 is currently developing a new set of Standards for Arctic Operations including ice management, escape, evacuation and rescue, ice monitoring, and other activities.

## Bottom-Founded Exploration Drilling Structures

Gravel island construction was used extensively in the 1980s for exploration in the Beaufort Sea to provide the foundations for a drilling rig and supporting facilities, with 17 wells drilled out to water depths of close to 15 meters using this technique.

Ice as an engineering material was also used to construct temporary islands to support drilling operations as shown for the Mars Spray Ice Island offshore

Alaska and the Tarsiut Relief Spray Ice Island offshore Canada in Figures 6-6 and 6-7.

The need to move exploration drilling into deeper waters led to the development of different substructure forms using caisson retained islands and then bottom-founded gravity-based structures. Five different types of caisson retained islands and GBS exploration platforms have been deployed in the Beaufort Sea:

- Tarsiut Caisson Retained Island (concrete caisson retained island)
- Molikpaq Mobile Arctic Caisson (steel GBS type MODU)
- Caisson Retained Island (steel caisson retained, sand-filled island)
- Single Steel Drilling Caisson (SSDC, steel GBS MODU with later addition of steel substructure)
- Concrete Island Drilling System (CIDS).

The Tarsiut concrete caisson retained island was the first man-made structure deployed offshore in the Beaufort Sea. This type of artificial island construction provided an economic extension of gravel island construction into deeper waters.

The Molikpaq steel GBS MODU was first deployed in the Canadian Beaufort Sea and was subsequently redeployed offshore Sakhalin Island as an early production facility and it continues to be in operation today. The Molikpaq is the most important of these early exploration structures:

- The structure was designed to resist interactions with both first-year and multi-year ice.



Photo: BP – Amoco.

**Figure 6-6.** *Spraying Mars Island 1986*



Photo: G. Timco.

**Figure 6-7.** *Tarsiut Caisson Retained Island and Ice Relief Well Pad*

- The structure experienced several encounters with major multi-year ice features in 1986.
- A significant level of instrumentation was installed on the platform to measure ice loads.

The Molikpaq currently remains as the most significant source of measured full-scale, multi-year ice loads on a structure, and the results from these events form the basis of the design ice load requirements contained in both API (American Petroleum Institute) and ISO standards for design of offshore platforms in ice.

The steel caissons for the Caisson Retained Island are similar caisson structures as the Tarsiut Island except that the caissons were connected together to improve their stability when subjected to ice loads. The SSDC is a large GBS-type MODU that was constructed from the midsection of a VLCC tanker (very large crude carrier). The hull perimeter was strengthened to resist direct contact with ice loads. The water depth range and the seabed stability requirements

of the SSDC were subsequently enhanced with the addition of a new steel substructure called the MAT. The combined structures are now referred to as the steel drilling caisson (SDC), and the system has been deployed both offshore Alaska and Canada. The structure currently remains in storage in the Canadian Beaufort Sea but could be redeployed outside of the Beaufort Sea.

The CIDS exploration structure is a concrete/steel hybrid GBS platform that was constructed in 1983 in Japan for exploration offshore Alaska. The CIDS drilled three prospects offshore Alaska before activity in the Beaufort Sea slowed. The CIDS structure was laid up in Alaska and then subsequently modified and redeployed in 2005 as a production facility offshore Sakhalin Island as part of the Sakhalin-I project. It remains in operation today as the Orlan drilling and production facility.

## Floating Structures

Offshore drilling in the North American Arctic using floating drilling units began in 1976, when Canadian Marine Drilling Ltd., a subsidiary of Dome Petroleum, brought a fleet of vessels into the Canadian Beaufort Sea by way of the Bering Strait and Point Barrow. This fleet included three ice-reinforced, spread-moored drillships and a support fleet of four supply boats, along with a number of work and supply barges and a tugboat (Figures 6-8 and 6-9).

These vessels were designed to be overwintered in the Beaufort Sea, which allowed an early start in the following season as the drilling areas often had open water conditions several weeks before the approaches to the Beaufort Sea around Point Barrow, Alaska, opened.

This equipment extended the ability to carry out exploratory drilling in water depths beyond the range of artificial islands and bottom-founded structures. However, spread-moored drillships had their limitations for Beaufort Sea work as their mooring systems were not able to resist significant interaction with ice while drilling. This was not a significant impediment during the open water season, but as freeze-up approached, this limitation was addressed by using ice-worthy support craft in ice-management roles so that ice loads on the moored vessels could be maintained within acceptable limits.

A fourth drillship was added to the Canmar fleet and, in 1979, a unique icebreaking offshore vessel the *Kigoriak* (Figure 6-10) was added. The *Kigoriak* incorporated many novel features that were designed to enhance the offshore operations and ice management capabilities in support of Arctic offshore drilling.

A second major player in the development and use of floating drilling units in Arctic waters was Gulf Oil Canada. The company, through its subsidiary Beaudril, invested in a number of innovative purpose-designed and -built units including four



Photo: R. Pilkington.

**Figure 6-8.** *Canmar Drillship Operating with Ice Management in the Canadian Beaufort*



Photo: BP – Dome Petroleum/Canmar.

**Figure 6-9.** *Canmar Ice-Worthy Offshore Supply Vessels*



Photo: A. Keinonen.

**Figure 6-10.** Kigoriak Ramming in Heavy Ice

icebreaking ships and a conical, ice-worthy drilling unit, the *Kulluk*.

The *Kulluk* (Figure 6-11) was designed to operate in early winter ice up to approximately 1.25 m thickness and did so successfully in the early 1980s. However, with the downturn in Arctic drilling that followed the depression of oil prices in the 1980s, the unit was laid up in the Arctic for many years with only brief operational periods, until she was acquired by Shell and reactivated to support the Beaufort Sea-Chukchi Sea exploration program in the late 2000s. The unit met an unfortunate end when she was seriously damaged on a tow out of the Arctic and was subsequently scrapped in China in 2014.

### Current State of the Technology

As described in the previous section, the technology for exploration drilling from artificial islands, fixed platforms, or floating rigs is well established. However, the current inventory of exploration rigs is limited (e.g., *Noble Discoverer*, *Stena DrillMax Ice*) pending opportunities that would justify the investment in new equipment. Most drilling contractors have new designs for Arctic-class drilling rigs of all types. Enhancements to existing rigs and proposed new-build designs are in the areas of winterization, automation, design for ice loads, and station-keeping.



Photo: Gulf Canada Resources.

**Figure 6-11.** Beadril Drilling Unit  
Kulluk in Ice

The current state of practice is assumed to be represented by Arctic offshore activities in the recent years since 2000. As in the previous section, the discussion is divided between bottom-founded and floating drilling platforms for exploration drilling.

### Bottom-Founded Structures

In recent years offshore Arctic and sub-Arctic exploration has moved further offshore into deeper waters, and the majority of exploration drilling has been conducted from floating rigs. However, there have been two exploration drilling programs in the Beaufort Sea since 2000. Both were conducted using the previously discussed bottom-founded structure referred to as the Steel Drilling Caisson/MAT:

- 2002/2003 Well: McCovey Operator: Encana Alaska
- 2005/2006 Well: Paktoa Operator: Devon Canada

In the future, it is anticipated that exploration drilling in shallow water depths will continue to be conducted from bottom-founded structures. These may include:

- Artificial islands—either sand/gravel or temporary spray ice islands
- Existing GBS exploration structures such as the steel drilling caisson
- New purpose-built GBS exploration platforms
- Self-elevating MODUs (commonly referred to as jack-up units because large jacks are used to push legs into the seafloor and then lift the drilling barge above the water surface).

Due to their very high cost and lack of suitability for drilling outside of Arctic waters, future new-build mobile GBS exploration structures are unlikely to be constructed unless they are dedicated to a large, multi-well campaign in similar water depths or if they are also to be dedicated to appraisal drilling or development programs.

There are many offshore Arctic areas of potential exploration interest in relatively shallow water (<50 m), which may have a significant open water season (>12 weeks). Consequently, there is increasing interest in using jack-up units for exploration during the open water season in several Arctic locations such as the Chukchi Sea, Pechora Sea, and also the Kara Sea. Some jack-up rigs with moder-

ate ice strengthening exist, but they are not intended for drilling in the presence of ice. Designs of more ice-capable rigs have been developed within industry that provide protection for the drilling riser as well as strengthening of legs to withstand contact with some level of ice (an example of which is found in Noble et al.<sup>8</sup>).

### Floating Structures

Recent Arctic or sub-Arctic exploration drilling from floating rigs includes the following exploration areas:

- Chukchi Sea/Beaufort Sea (Shell)
- West Greenland (Cairn Energy)
- Flemish Pass Newfoundland (Statoil)
- Norwegian Barents Sea (Statoil)
- South Kara Sea (ExxonMobil)

**Chukchi Sea/Beaufort Sea.** During the 2012 exploration drilling season, Shell initiated drilling at the Burger Prospect in the Chukchi Sea and the Sivulliq prospect in the Beaufort Sea. Shell submitted revisions to its previously approved Plan of Exploration in November 2013 to the Department of Interior for continued exploration in the Chukchi Sea. Shell plans to complete the drilling of exploration wells at the Burger Prospect over a number of drilling seasons.

**West Greenland.** The government of Greenland first granted offshore licenses for petroleum exploration in the 1970s and to date 14 exploration wells have been drilled offshore Greenland.

The offshore waters of western Greenland are sub-Arctic with large periods of open water in the summer and fall months. However, large icebergs are calved in the fjords of Disko Bay and other locations, and the protection of a drilling vessel from iceberg encroachment is the primary challenge. Iceberg management is employed to identify, monitor, and ultimately to tow icebergs away from a potential encounter with station-keeping vessels. Very large icebergs in the range of 5 million tons have been successfully towed or diverted.

Nine wells have been drilled since 2000 using either a drillship or a semi-submersible rig. These were harsh environment, but non-ice-strengthened, rigs with drilling conducted in open water conditions, free of sea ice. Iceberg management used a strategy

of either iceberg towing, or rig disconnect, to avoid contact with icebergs.

**Offshore Newfoundland.** Offshore Newfoundland is a sub-Arctic environment exposed to some seasonal sea ice and also significant icebergs incursions during the spring and summer months. Exploration in the shallow water conditions in the Jeanne d'Arc Basin on the Grand Banks has been conducted from anchored semi-submersible rigs suitable for harsh environments. Exploration drilling in deeper waters (1,000-2,500 m) is undertaken safely year-round using modern, winterized dynamically positioned rigs (drillships and semi-submersible rigs) suitable for deepwater. Three wells have been drilled safely in the Orphan Basin (~2,500 m water depth), and seven wells have been drilled safely in the Flemish Pass Basin (~1,000 m water depth).

From May to July, icebergs driven by the Labrador Current are transported from Greenland, toward Jeanne d'Arc Basin and inboard areas. Ice management is conducted to manage operational risk by detecting ice and avoiding contact with drilling and production installations. Iceberg management has been practiced successfully for the past 30 to 40 years using established industry capability. Iceberg detection is by aircraft surveillance, radar, and satellite technologies, with management using dedicated support vessels for physical towing or redirection.

**Norwegian Barents Sea.** The Norwegian Barents Sea is within the Arctic Circle, although the great majority of the area is free of sea ice year-round due to the influence of the Gulf Stream. The Barents Sea South was opened up for exploration in 1980, and to date, 112 wells have been drilled, with a high percentage of discoveries, but only a few of them deemed commercial to date. In 2013, new acreage was opened following the agreement of border delineation between Russia and Norway. Exploration in the Barents Sea South is carried out using harsh environment semi-submersible rigs, with all-year drilling taking place in most parts. There is the possibility for encountering sea ice in some years, and icebergs can be present. The most northern licenses in the Hoop area were safely and successfully drilled in summer 2014, with winterized semisubmersible rigs and with the availability of capping stacks and the provision for relief drilling if required. Ice management was applied to

monitor and mitigate risk from ice and icebergs in the area. Under the current framework for Barents SE, drilling into hydrocarbon bearing formations is not permitted within 50 km of the mobile ice edge for some months of the year.

**South Kara Sea.** The Rosneft-ExxonMobil Joint Venture has drilled an exploration well at the Universitetskaya structure in the South Kara Sea that began in August and ended in October 2014. The well was drilled in open water in about 80 meter water depth using a conventional, winterized, moored semi-submersible rig, the West Alpha. The West Alpha rig was towed from Norway through the Barents Sea and Kara Gate to the drill site. With the exception of scattered small icebergs, ice in the South Kara Sea completely disappears in the summer and does not return until freeze-up, which usually occurs in mid-to-late October. The Rosneft-ExxonMobil drilling program incorporated an "ice defense" program that used satellite and airborne imagery, along with enhanced marine radar, to detect any floating ice in the area so that support vessels could deflect or tow it away from a preset ice exclusion zone around the rig. The West Alpha rig completed operations and was towed back to the North Sea prior to the return of sea ice to the South Kara Sea.

## Prudent Development Context

It is well understood within industry and the general public that exploration drilling systems include many components that must perform reliably to insure crew safety and protection of the environment from a potential release of hydrocarbons. Hence, prudent development requires a high level of performance for the drilling platform and supporting operations. Exploration drilling platforms deployed in the Arctic may range from existing harsh-environment rigs to purpose-constructed Arctic platforms capable of year-round operations. Prudent development requires that the type of rig deployed operates only within the design environmental conditions and that sufficient ice monitoring and ice defense capabilities are also deployed to ensure that all operations are conducted in a safe manner. Ice management is discussed in detail in the "Ice Management" section later in this chapter, and the potential for interactions of ice management operations with ice-dependent species is highlighted in that section's "Prudent Development Context" discussion.

Finally, the cost of a new, purpose-built Arctic exploration drilling rig (bottom-founded or floating) could exceed \$1.5 to 2 billion. This represents a significant capital expenditure for a rig that may not be readily deployable to temperate theaters if sufficient prospects are not found in the Arctic to keep such a rig gainfully employed. Such rigs are unlikely to be developed for those regions where operations are limited to open water only. Hence, prudent development will most likely be constrained by the need for early, large discoveries in those areas with sufficient open water season to use available exploration rigs (e.g., drillships or jack-up rigs). Such discoveries would be needed to confirm the incentive for designing and constructing new purpose-built, high-capability Arctic rigs for more challenging environments.

## Recent and Ongoing Research

The preponderance of research on Arctic exploration drilling is focused on season extension and addresses station-keeping and ice management. Ice management and station-keeping for floating drilling platforms are discussed in later sections of this chapter.

Recent Arctic drilling activities have included scientific coring programs, sometimes in high latitude locations within the polar ice pack. These programs were relatively shallow coring programs that did not enter hydrocarbon zones. However, these programs have been conducted in challenging ice conditions and provide good field experience with respect to station-keeping in ice. These programs include:

- 2004 ACEX Program—Lomonosov Ridge
- 2008 Northeast Greenland
- 2012 Northwest Greenland

**ACEX 2004.** The Arctic Coring Expedition (ACEX) was an Integrated Ocean Drilling Program conducted by the European Consortium for Ocean Research Drilling and the Swedish Polar Research Secretariat in 2004. This was a science drilling program of the seafloor to study environmental changes, deep biosphere, geophysics, and geodynamics of the earth. The drill site was located on an elevated topographical feature of the seafloor, the Lomonosov Ridge, at a point only 250 km from the North Pole.

ACEX was a major logistical challenge for a science expedition as the coring vessel was required to

station-keep in a fixed location while in mobile polar pack ice very near to the North Pole, similar to an offshore drilling program. This required two polar class icebreakers, the Swedish icebreaker *Oden* and the Russian *Sovietskiy Soyuz*, to act as ice management vessels to protect the drilling vessel, the *Vidar Viking*. The operation is shown in Figure 6-12. The *Vidar Viking* is an ice-class anchor handling vessel that was specially converted for the drilling task. The science drilling program was successfully completed and demonstrated the capability for drilling in heavy ice with a very capable ice management system.

**Northeast Greenland 2008.** The 2008 Northeast Greenland Stratigraphic Coring Project was the second multi-icebreaker Arctic coring project. Statoil acted as operator on behalf of the Kanumas group, consisting of BP, Chevron, ExxonMobil, JOGMEC, Shell, Statoil, and Nunaoil. Two of the vessels used in ACEX 2004 were deployed, the *Vidar Viking* was again used as the drillship and the polar class supporting icebreaker was the *Oden*. An aerial view of the ice management operation at one drill site is shown in Figure 6-13. Nine boreholes were drilled in 28 days, penetrating a total of 731 meters. The *Vidar Viking* operated in a dynamic positioning mode with some manual intervention. The project was very successful and demonstrated that this type of operation can be safely undertaken with the appropriate risk assessment and mitigations using vessels of appropriate ice



Photo: M. Jakobsson.

**Figure 6-12.** Ice Management and Drilling During ACEX 2004

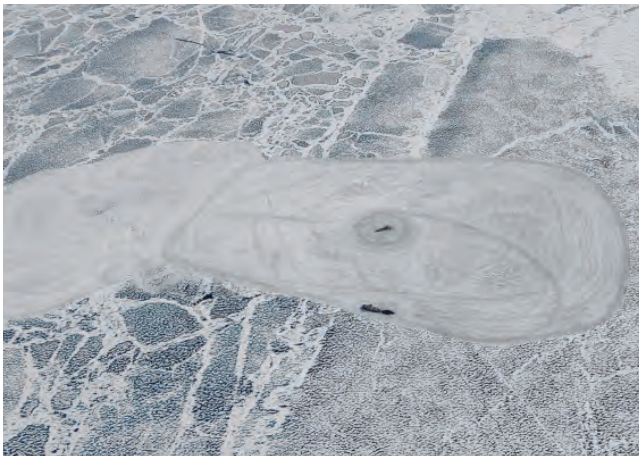

Photo: Ulf Hedman, Arctic Marine Solutions AB, Sweden.

**Figure 6-13.** 2008 Northeast Greenland Geotechnical Drilling Operations

breaking capability, mastered by experienced officers, and supported by skilled ice management staff.

**Northwest Greenland 2012.** During 2012 Cairn participated in a joint regional and shallow (up to 800 meters depth below mudline) borehole drilling program in Baffin Bay, operated by Shell on behalf of an industry consortium that includes ConocoPhillips, GdF, Nunoil, Maersk, and Statoil. This extensive core gathering program completed eleven boreholes and for the first time established a stratigraphy for the Baffin Bay Basin.

## Potential Technology Enhancements

Significant technology development has occurred in the design of bottom-founded and floating ice-class rigs and supporting ice-class vessels since the 1980s. As discussed above, the full deployment of these technologies requires a critical mass of Arctic exploration opportunities and an operating framework that will justify the future investment. Construction of new rigs is principally the responsibility of industry to progress at a pace consistent with the identified incentives. These are platforms for which the basic technology needed to construct them exists, but it is anticipated that improvements will derive from the process of designing new rigs. These would include:

- Bottom-founded MODUs for shallow water exploration
- Floating rigs for exploration drilling in moderate/deeper water depths including sea ice incursions.

Supporting technologies that will help enhance the capabilities of these rigs include the following. Some represent research or design/development opportunities, some are more appropriate for industry investment, and some would serve to inform key policy issues.

- Further full-scale field measurements of ice loads on floating structures under different ice conditions are required to advance safety and efficient station-keeping operations in ice
- Higher-capacity mooring systems with commensurate quick disconnect/reconnect capability for effective station-keeping in heavier ice conditions
- Technologies to support new purpose-built Arctic class drillships or other specialized drilling vessels that will increase the operability window for Arctic exploration drilling (e.g., automation, winterization)
- Enhanced positioning capability at high latitudes (geomagnetic reference field) is important for drilling activities.

Not included in the above are exploration drilling-related technologies under the following headings: data acquisition; ice management; oil spill response; escape, evacuation, and rescue (EER); ice monitoring and forecasting; aviation; and infrastructure. All of these are captured in other sections and chapters.

## ICE MANAGEMENT

Keeping operations safe around or in ice is the domain of ice management. Ice management refers to a range of marine activities used to mitigate the impacts of sea ice or icebergs on (primarily) floating exploration or production operations. The key elements of all ice management systems include: (1) ice and weather forecasting, detection, and monitoring; (2) an ice threat evaluation and ice alert system consistent with the objectives and risk of the operation; and (3) support vessel(s) conducting physical ice management by breaking, pushing, washing, or towing or providing ice reconnaissance. Ice management can range from simply tracking ice features in the area of operations in order to inform ice avoidance decisions, to deflecting or towing ice features away from an operation, to using icebreakers to continuously break large sea ice floes into smaller fragments in order to mitigate loads on a station-keeping

vessel. Key to any ice management program is a common operational picture (COP) or dedicated situational awareness system to support the complex data acquisition, interpretation, and display needs and the need for optimized command and control of a multi-vessel fleet. Figure 6-14 provides a schematic representation of the elements of an integrated ice management program.

While there are many potential roles for ice management in providing protection from ice interaction, the primary role of interest to this study is the reduction of ice-induced loads to facilitate station-keeping by floating vessels. The station-keeping vessel(s) could be a drilling rig, a tanker engaged in offshore oil loading operation, a maintenance or repair vessel, or an emergency response vessel. In some cases, the protected rig could be a bottom-founded drilling platform or even a jack-up rig. Ice management allows these operations to be safely conducted during periods when there is potential for vessel interaction with sea ice or icebergs. Hence, it is a key enabling technology because it prevents or reduces ice-induced interruptions and provides the opportunity to extend drilling or other key floating operations into the ice season.

Under the current Arctic ice climatology, there is no threat of icebergs in the U.S. offshore Arctic, so the focus of this chapter is on ice management to mitigate the effects of sea ice. While ice islands would be detected by the monitoring program of an ice management system, they are unlikely to be breakable by vessels.

### Unique Aspects of Application in an Arctic Environment

The U.S. offshore Arctic environment is characterized by mobile sea ice during 9+ months of the year. Depending on the length of the open water season in a given location, many marine-based exploration operations, and some development operations, can take place when ice is not present. When floating operations that involve station-keeping are conducted in the ice season, some form of supporting ice management is typically required. This is because floating vessels, whether they are moored to the seafloor or dynamically positioned, have a finite ability to resist the loads imparted by moving ice. The degree to which such vessels can safely withstand ice interactions varies with ice conditions and the vessel's ice

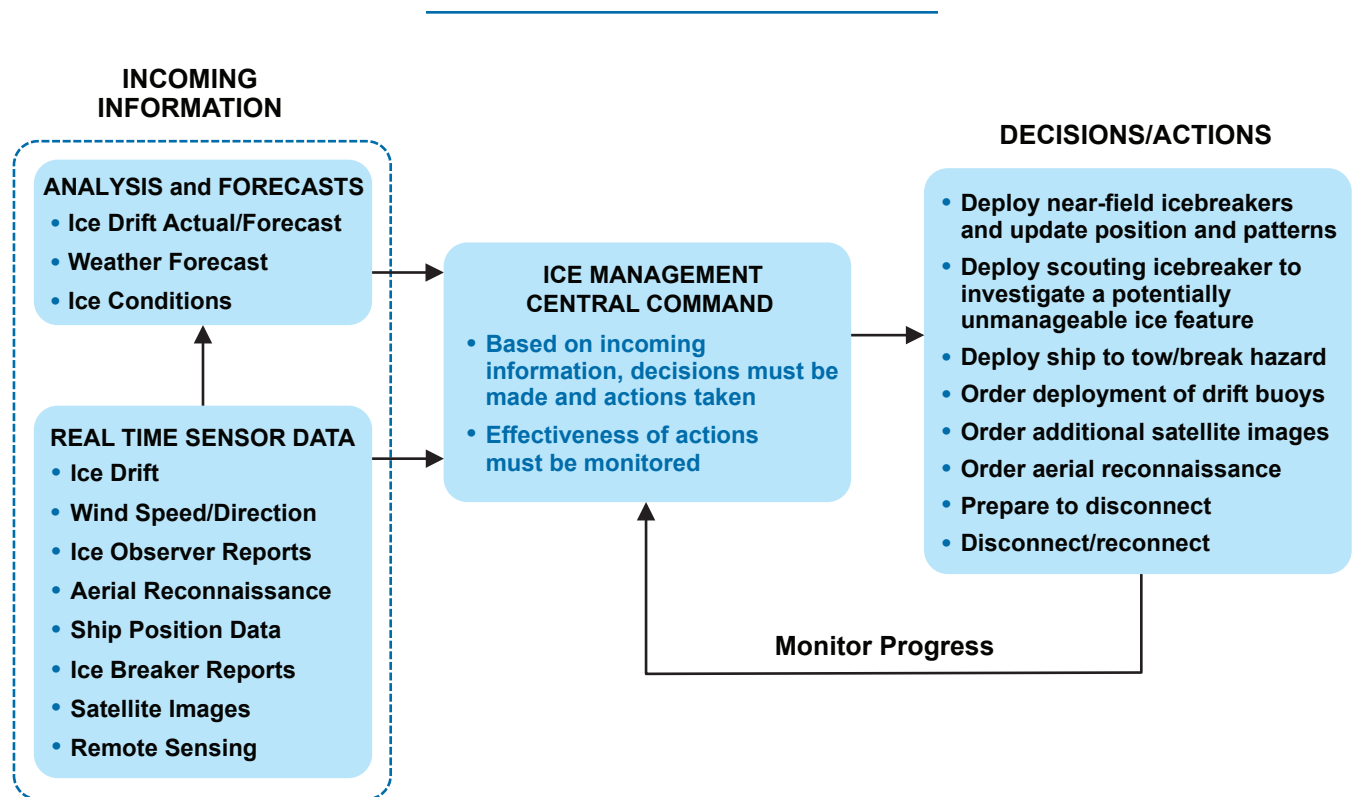

Source: ExxonMobil.

Figure 6-14. Schematic of an Integrated Ice Management Program

worthiness and station-keeping capacity, but owing to the practical limitations of mooring systems, all floating systems are vulnerable to being pushed off station by some measure of unmanaged sea ice or large icebergs.

The sea ice conditions under which ice management can take place represent a continuum that depends on the time of year and the local ice condition, which correlates generally with latitude in the U.S. Arctic. The difficulty of conducting successful ice management operations correlates with ice conditions and can range from near trivial to quite challenging. First-year ice conditions range from very thin newly formed ice during early freeze-up (October-November) to greater than 1.5 meters of ice near the end of winter (March-April), followed by rotten, melting ice in the late summer months (July-August). Ridging and rafting of ice sheets during the winter can thicken the pack in localized areas. The U.S. Arctic polar pack often carries multi-year ice floes or fragments of floes with level ice thicknesses that exceed 3 to 4 meters. Unless this multi-year ice is very rotten near the end of the summer melt season, it presents a more significant challenge to ice management due to the difficulty for icebreakers to efficiently break it into smaller floes. Hence, ice management to support extended season exploration drilling can vary in complexity depending on the length of the extension. Winter season ice management to support offloading to tankers must deal with more challenging ice; however, the station-keeping time intervals are much shorter and positional tolerances are much higher than for drilling operations.

COP systems are used in offshore Arctic marine operations to facilitate common situational awareness and decision-making. Specific Arctic challenges motivating the use of a COP include the complexity and remoteness of the operations that include many geographically distributed parties and stakeholders, dynamic ice environments, and challenging weather conditions with limited visibility. The need for COP systems is not limited to ice management, as it is a routine component of many complex marine operations and oil spill response.

## **History of Technology Development and Application in Arctic Conditions**

Offshore exploration and production operations requiring ice management have been successfully

conducted since 1976 in Canadian, U.S., Russian, and Greenland waters and in the North Caspian Sea. Dome Petroleum and Gulf Canada Resources Ltd. used ice management to extend the drilling season for exploration wells in the Canadian Beaufort between 1976 and 1993. Both fixed-heading, spread-moored drillships (the Canmar drillships) and an axisymmetric floating drilling barge (Beaudril's *Kulluk*) operated with up to four icebreakers providing ice management both during summer season ice invasions and during the “shoulders” of the summer open water season as thoroughly described by Timco and Frederking.<sup>9</sup> In all, 51 wells were drilled using the Canmar ice-strengthened drillships or the *Kulluk* drilling rig with the aid of effective ice management programs. With the support of ice management, the very ice capable *Kulluk* was able to drill in the presence of high concentrations of pack ice as early as June in the summer and into December during the freeze-up period.<sup>10</sup> The drillships, which were spread moored and unable to weather-vane into the ice-drift direction, were able on a few occasions to stay on station and drill into the October-November thin-ice season. During these campaigns, good records were kept of ice conditions and the corresponding vessel alert status.

The recently retired *Kulluk* was the only floating exploration drilling rig designed to operate in harsh ice conditions. The vessel had a circular hull shape, with a downward-breaking conical hull and mooring system capable of resisting about 100 tons of ice load. It was designed to resist the loads from interaction with unbroken level ice up to 1.2 meters thick.<sup>11</sup> In some deployments, the *Kulluk's* mooring loads were measured, and those load measurements are still being used by researchers to calibrate numerical and test basin measurements of managed ice loads on floating vessels.

In recent years, floating drilling operations have been conducted in primarily open water with the support of ice management to track nearby sea ice or icebergs and prevent ice contact with the drilling rigs. Such operations (as documented in the “Exploration Drilling Platforms” section earlier) were conducted by Shell in the U.S. Beaufort and Chukchi Seas in 2012, by Cairn in the iceberg environment off the west coast of Greenland in 2009-2012, by Statoil and others in the Grand Banks and Flemish Pass, and by ExxonMobil and Rosneft in the Kara Sea in 2014.

While these programs all avoided ice contact with the drilling rigs, they did involve extensive use of ice management system technologies to successfully avoid ice interaction and/or emergency disconnection.

Experience with non-drilling-related ice management operations has been gained through several projects that involved tanker loading and construction in ice. The Sakhalin Energy Investment Company used risk-based ice management operations offshore Sakhalin Island in the 1990s and early 2000s to extend oil offloading operations into the new ice growth season in November-December at the single anchor leg mooring system (SALM) buoy connected to the Molikpaq platform. They also conducted a pioneering operation in the spring of 1999 wherein the dynamically positioned work vessel, the *CSO Constructor*, was successfully used to conduct underwater diver-based construction activities in dynamic, fairly thick first-year ice with the assistance of ice management.<sup>12</sup>

Ice management is currently being used to facilitate two offshore tanker hook-up and loading operations in the Russian Arctic: Lukoil's Varandey offshore oil loading terminal in the Pechora Sea and Gazprom's tanker offloading operations from the Prirazlomnoye platform, also in the Pechora Sea.

COP technology has been used in historical operations, including early Beaufort Sea exploration activities, the ACEX, and Grand Banks exploration and production operations. These historical operations used COP technology to support ice management activities, including tracking and forecasting of hazardous ice conditions relative to alert zones around the ongoing operation. Several commercial COP products are identified in a review of the marketplace by Tiffen et al.,<sup>13</sup> and it is noted that proprietary tools have also been used in recent Arctic operations. Moreover, considerable development activity is occurring for COP systems for management of other multi-vessel marine operations. In particular, recent recommendations stemming from the Macondo incident have stimulated development efforts for COP technology targeted at oil spill response. The general functionality of a modern Arctic COP includes the capability to process, store, display, and share common GIS formats that can include ice data, weather data, satellite imagery, and vessel and aircraft position data. Taken in context of the required functionality, a review of

recent and ongoing activity suggests industry efforts are targeted at assembly, customization, or enhancement of existing technology rather than development of new technology.

## Current State of the Technology

Ice management is a proven technology for assisting station-keeping in a mobile ice environment. It is currently being used to support Arctic floating exploration drilling operations in the open water season. It was used extensively to support exploration floating drilling in ice from the 1970s through the early 1990s. These programs demonstrated the effective use of ice management to support floating drilling with the *Kulluk* rig and Canmar drillships during the late summer and early winter "shoulder" ice seasons. Ice management has not been used since then in support of hydrocarbon drilling by a rig in contact with ice. This is largely due to cost, operating framework restrictions, and limited availability of ice resistant drilling rigs. The components needed to conduct an ice management operation, from ice surveillance and data processing to very maneuverable icebreakers, have advanced considerably since the early 1990s and have been demonstrated to a large extent by recent programs that are discussed later.

Depending on the season and location, the demands on an ice management operation in terms of intensity and criticality for drilling operation reliability can vary from relatively routine to quite challenging. Current ice management capability has been demonstrated to be adequate to support extended season exploration drilling operations during a mid-season pack ice invasion or during several weeks into both shoulders of the open water season. However, the combination of ice management and ice-capable floating rigs has not advanced to the state required to allow economic, year-round floating drilling of development wells.

Ice management capability to support offshore tanker loading operations is much less demanding than for drilling because the time required to remain connected is short, the need for precise position control during the station-keeping operation is less, and tanker disconnection/reconnection operations can be accomplished quickly and with comparative ease. As mentioned earlier, risk-based ice management was successfully used to support seasonal tanker export

of oil by the Sakhalin-2 project prior to installation of permanent export subsea pipelines.

COP technology is essential to control a complex ice management program. This need is being adequately served by the marketplace, wherein multiple systems are available and are being actively enhanced to serve industry needs.

## Prudent Development Context

Ice management operations typically require the support of multiple icebreaking vessels, which are costly to build and operate. Use of ice management can generate a significant cost premium for operations in the Arctic that would not be incurred in temperate environments. However, ice management can enhance prudent development by enabling extended season operations, which reduce the number of operating seasons and increase exploration commercial feasibility.

Ice management operations are used to allow station-keeping and facilitate safe operations in ice for both exploration (e.g., drilling) and production (e.g., offloading). In addition, ice management could have a role in facilitating emergency response activities during extended season operations. Hence, ice management technology can play an important role in health, safety, and environmental (HSE) management throughout the E&D lifecycle.

Ice management operations conducted during times of significant ice coverage necessarily involve the breaking of sea ice into smaller floe sizes and the creation of numerous channels in the wake of the ice management icebreakers. Such channels refreeze in a matter of hours in the winter, but may remain filled with broken ice during the summer season. Depending on the season and the location of the operations, consideration must be given to the potential impact of ice management operations on usage of the ice by marine mammals in the area. This requires understanding of the specific nature of any marine mammal usage in the local area of icebreaking activities. There have been no documented incidents wherein historical ice management operations have impacted marine mammals.

Another prudent development consideration is air emissions. Ice management requires multiple marine vessels operating in an area, and depending on fuel type, they are potential sources of air emissions.

## Recent and Ongoing Research Activities

Considerable research has been conducted over the past decade on the topic of ice management. This research is driven by renewed industry interest in the use of floating drilling platforms for exploration drilling in the Arctic along with the desire to understand the economics of floating development well drilling in water depths beyond the reach of bottom-founded structures. The ice management research generally falls into categories of (1) ice management tactics and floating structure performance in managed ice and (2) improvement of supporting technologies (e.g., ice monitoring and forecasting) for ice management operations.

Several research projects have focused on prediction of managed ice loads on floating vessels (for example, see Petroleum Research Newfoundland & Labrador<sup>14</sup>). Much of this research has been driven by considerations for design of dynamically positioned vessels for exploration drilling in the presence of ice. Several researchers have reported on use of numerical simulation to study ice management tactics as a means to test system reliability and inform future field implementation (for example, see Hamilton et al.<sup>15</sup>). Many have reported on floating drilling concept designs and disconnection capabilities for vessels drilling in a managed ice scenario (for example, see Løset et al.<sup>16</sup> and Kokkinis et al.<sup>17</sup>). Some have examined the question of how to achieve ISO standards for offshore structure reliability performance targets with systems that rely on active ice management to mitigate loads (for example, see Eik and Gumestad<sup>18</sup>).

ExxonMobil and Statoil have conducted full-scale field trials of ice management operations using modern icebreakers operating in challenging ice environments. ExxonMobil's 2009 field trials (pictured in Figure 6-15) were conducted in largely second-year ice in the Fram Strait using the icebreakers *Oden* and *Fennica* as reported by Maddock et al.<sup>19</sup> Icebreaker performance characteristics were measured along with corresponding local ice thickness profiles to develop vessel performance models for use in ice management simulation.

Statoil performed similar trials in 2012 and 2013 using the icebreaker *Oden* in challenging ice conditions off of the northeast coast of Greenland.<sup>20</sup>



Photo: ExxonMobil.

**Figure 6-15.** 2009 Ice Management Trials in the Fram Strait

The 2005 Arctic Coring Expedition project (described in the “Exploration Drilling Platforms” section earlier in this chapter), which involved drilling geotechnical sample borings in ~1,500 m water depth near the North Pole,<sup>21</sup> was a successful full-scale demonstration of modern ice management techniques in Arctic pack ice.

Considerable research is/has been conducted on technologies that support ice management, such as instruments for ice measurement and monitoring and ice drift forecasting methods. A good example of recent work on ice measurement instruments is discussed in Garas et al., who describe potential use of multiband airborne synthetic aperture radar for wide-swath ice thickness measurements.<sup>22</sup> Research of this type is documented in Chapter 5 of this report, which deals with characterization of the ice environment. Blunt et al. describes recent advances in ice drift forecasting methodology for support of ice management operations.<sup>23</sup>

### **Technology/Capability Enhancement Opportunities**

While ice management operations were successfully employed to support past floating exploration drilling activities in ice, it has been more than 20 years since the industry has conducted hydrocar-

bon drilling using a floating vessel that is in contact with ice and relies on active ice breaking to keep station. Hence, there are opportunities to integrate more modern technology components (ice surveillance, data processing, computer-based COP, better vessels, etc.) into the ice management toolkit. Industry has been working toward this end for about a decade commensurate with the resurgence of interest in the Arctic, and many enhanced ice management technology components have been used to support recent open water drilling campaigns in the U.S. Arctic and the Kara Sea. The desire to safely extend the operational window for floating drilling further into the ice season will continue to provide opportunity for advancement of ice management technology to improve performance in more severe ice conditions.

Since all of the component technologies needed to execute and control ice management exist, perhaps the most important research opportunity would be policy-oriented studies focused on understanding and mitigating potential impacts of ice management on ice-dependent species. This would involve studies to develop a detailed characterization of marine mammal use of OCS sea ice to understand potential impact of localized ice management operations. Such studies could include development of advanced means for monitoring animal presence in very specific areas representative of those surrounding a drilling operation.

Also important for maximizing extended season for operations (beyond what has already been demonstrated for the June to early December shoulder seasons) would be field demonstration tests to define the maximum severity level of ice conditions under which modern ice management technology can reliably operate. Such demonstration tests would exercise to the fullest possible extent all of the key components of an ice management program suitable for floating drilling station-keeping in pack ice. Such demonstration tests would be very valuable in answering stakeholder and regulatory questions regarding the level of ice conditions under which such operations can be reliability conducted along with providing important data related to the above issue of how such operations interact with the environment. Hence, such demonstration tests should be conducted in collaboration with key regulatory and stakeholder technical representatives.

An additional technology enhancement opportunity involves ice management component technologies that could be enhanced to support operations in increasing severity of ice conditions. The first four of these related to characterization of the ice environment and are discussed in Chapter 5, but repeated here to emphasize their importance to ice management. There is always opportunity for more and improved icebreakers designed specifically for optimum performance in ice management operations. However, this is more of an industry investment need versus a research need.

- Improved airborne ice surveillance instrumentation for broad-area ice thickness measurement and identification of potentially difficult or hazardous ice
- Improved ice drift monitoring and forecasting to aid the command and control of operations and reduce operating conservatism (e.g., improved multi-day weather forecasting methods and ice drift models)
- Availability of satellite ice surveillance imagery at more reliable and more frequent revisit intervals, (e.g., a U.S. public synthetic aperture satellite imagery source)
- Arctic COP is an area believed to be adequately supported by the commercial marketplace. In line with ongoing oil spill efforts, the industry should consider potential benefits from establishment of uniform practices or standards. Finally, Arctic COPs must be supported by a communication system. Potential enhancements to communications in the U.S. Arctic are considered elsewhere.
- Enhanced ship-based ice reconnaissance capability to allow better feature resolution and tracking in poor visibility conditions and also allow discrimination of multi-year and first-year ice (e.g., enhanced marine radar or ice imaging technology).

## **DEVELOPMENT DRILLING AND PRODUCTION PLATFORMS**

Development drilling and production platforms provide for year-round drilling and processing of produced hydrocarbons in the Arctic environment. Drilling and production functionality can be provided on a single integrated platform or the functions split and provided on separate platforms. For development

drilling, the platform plays host to the producing wells and provides the specialized support for drilling and completion activities while protecting the wells from the physical environment. For production, the platform supports and protects the equipment to process the produced fluids and gas to desired specifications (e.g., export, reinjection, discharge, or use for platform power generation). Bottom-founded platform types are most suited to the offshore conditions of the Alaskan shelf. Structures of this type include man-made islands and gravity based structures. Man-made islands are suitable out to 15 to 20 m water depth, depending upon location, and require a nearby source of sand or gravel material. Gravity-based structures (GBS) are suitable in deeper water depths and could be constructed from either steel or concrete or both and are usually constructed remotely from the field location and towed to position. Platform size is a function of water depth, ice conditions, soil strength and desired drilling, and production functionality. The platform would be designed using established design codes to withstand loads and effects from moving ice during the ice-covered portion of the year and wave and current loads and effects during the open water season.

### **Unique Aspects of Application in an Arctic Environment**

The technology for bottom-founded platforms is well established, with numerous examples in both the oil and gas and civil sectors around the world. Sea ice and cold temperatures are the unique aspects when bottom-founded platforms are used in an Arctic environment. Sea ice typically presents the dominant load that needs to be resisted for stability and structural design. Cold temperatures drive the need for winterization and special material specifications.

Man-made islands are best for shallow water depth, while GBS become viable when water depth provides sufficient float-in draft. Floating systems are required beyond the feasible upper bound water depth range of GBS (70 to 120 m depending on ice and soil conditions) but are beyond the water depth range of the study focus area. As discussed in the earlier section on exploration drilling platforms, key challenges of floating platforms are the loading capacity of existing mooring systems and cost.

**Ice Loads.** Sea ice is often not stationary, but moving. Moving sea ice creates lateral and overturning

loads that must be resisted by a fixed platform. An offshore structure has to be capable of breaking the incoming ice while remaining stable. Forces exerted on the structure by ice interaction should not cause damage to the structure in this process. Design for serviceability should allow for continuous operations on an island surface or platform topside during these interactions.

The principal design ice feature for nearshore structures in the Beaufort and Chukchi Seas will be first-year ice ridges and level ice. Ice ride-up and pile-up are potential hazards to people and equipment on the island working surface. The potential for ice damage to island slope protection also needs to be considered (as well as erosional forces from waves and currents during the open water period).

Multi-year ice floe and ridges will be the principal design ice feature for structures in the >15 to 20 m water depth range. Crushing or compressive loads will generally govern the design of vertical-sided GBS. Sloping sided GBS will predominately produce bending failure of the ice. Ice loads from bending failure are lower than those from crushing and therefore loads will be lower on a slope-sided GBS than for a vertical sided structure for the same ice feature. Ice buildup and clearing is also important. Other considerations are ride-up, abrasion, current scour at the structure base, and accumulation of ice on topside components. Finally, in addition to sea ice, the risk of ice islands and fragments needs to be considered in design.

**Winterization.** Topsides functionality would include facilities for oil and gas processing, utilities including power and living quarters, and drilling rig(s). This functionality is similar to any oil and gas installation, regardless of location. Arctic specific requirements are associated with winterization and human factor engineering. A key implication resulting from the need for winterization is heavier and more costly topsides relative to temperate and tropical climates for the same functionality.

**Materials.** The extremely low ambient temperature down to -50 degree Celsius requires special consideration for construction materials, most likely steel and concrete. Steels need to be carefully specified to ensure that brittle fracture is avoided. Ice abrasion is also of concern for concrete areas exposed to moving ice.

**Design Drivers.** Key aspects driving Arctic platform type and design are water depth, ice loads, and soil strength. Also important are well count, topsides payload, consumables storage, oil storage if tanker offtake, and metocean conditions. Other considerations include tow/float-in draft for a fixed platform (GBS) and wave and current effects for man-made islands. Construction and installation considerations depend on platform type and include proximity to construction materials (sand or gravel) for man-made islands, suitable fabrication yards for GBS construction, and availability of installation and construction equipment. Lastly, concept selection needs to address HSE considerations, including personnel safety, human factors design, health and environmental issues including marine sound, liquid and solids discharge, and air emissions.

## History of Technology Development and Application in Arctic Conditions

The industry has 50 years of experience with the use of fixed platforms in mobile sea ice environments starting with the installation of Cook Inlet platforms in 1964. Major civil marine structures have also been built to resist ice forces using the same methods. Some of the most notable (and highly instrumented and studied) are the Baltic Sea lighthouses and the Confederation Bridge piers between Prince Edward Island and New Brunswick. Modern design practice with respect to external loads and stability of Arctic offshore structures is codified in the ISO 19906 international design standard released in 2010.<sup>24</sup> A brief summation of this experience follows.

Man-made island experience in the Arctic goes back to the late 1960s and includes both exploration and production islands. Recent examples include the producing islands in the U.S. Beaufort Sea: Endicott, Northstar, Nikaitchuq, and Ooguruk. Man-made islands are also used in the Kashagan development in the North Caspian Sea, which is sub-Arctic but experiences mobile sea ice some 5 months of the year.

As described in the “Exploration Drilling Platforms” section, Arctic GBS experience goes back to the 1980s with the SSDC, CIDs and Molikpaq. All of these platforms were used in the U.S. and Canadian Beaufort Seas. Additionally, the SSDC and Molikpaq were instrumented with pressure panels and strain gauges that have contributed to improve understanding of ice loads and contributed to ISO 19906.

Recent GBS examples include:

- Arctic: Prirazlomnaya platform
- Sub-Arctic: Sakhalin-2, Lunskeye-A, Piltun-Astokhskoye-A (Molikpaq), Piltun-Astokhskoye-B platforms, and Sakhalin-1 Orlan platforms; and Berkut platform recently installed in the Sakhalin-1 Arkutun Dagi field
- Iceberg: Hibernia GBS platform and the Hebron GBS platform under construction for offshore Newfoundland.

Monolithic concepts like Orlan, Molikpaq, and Prirazlomnaya, or GBS concepts optimized for design loads (e.g., conical shaped) are most likely candidates to accommodate multi-year ice loads. Steel jacket structures as used in Cook Inlet and Bohai Bay, China, are not considered feasible for the U.S. Arctic due to insufficient resistance to withstand global ice loads resulting from interaction with multi-year ice.

Examples of the different structure types are shown in Figures 6-16 and 6-17.



Photos: Shell.

**Figure 6-16.** Example Cook Inlet Structure and Man-Made Island in Beaufort Sea

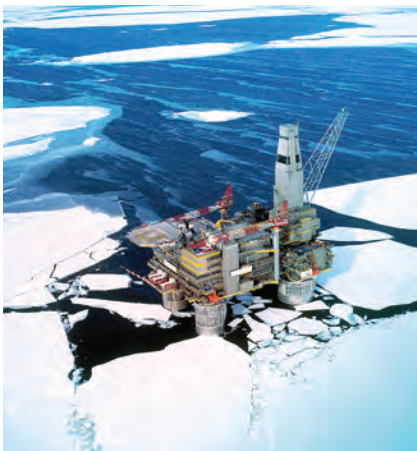
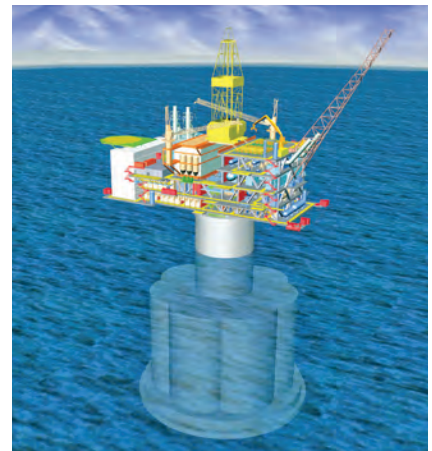

Photo: Shell.



Photo: Gazprom Shelf Neft.



Source: ExxonMobil Canada.

**Figure 6-17.** Examples of Gravity-Based Structures (l-r: Sakhalin-2 concrete platform, Prirazlomnaya platform, and Hebron platform)

## Current State of the Technology

**Design Standards.** The most important standard for Arctic offshore structures is ISO 19906. This standard, issued December 2010, codifies established practice based on input from leading experts across industry, contractors, government agencies, and academia. ISO 19906 has been broadly adopted by the Arctic states as the national standard. Numerous supporting standards from ISO, ABS, DNV, IMO, NORSOK, etc., complement and support ISO 19906. The U.S. Arctic will likely involve the first installation of a permanent structure in a multi-year ice environment. ISO 19906 has design methodology for structures in multi-year ice that is based on actual load measurements from the extensively instrumented Molikpaq mobile exploration drilling GBS, which experienced significant multi-year ice loads in the Beaufort Sea during the 1980s.

**Winterization.** Design for winterization is well established. Design features include heating or insulation of working and machinery spaces, tanks or compartments containing liquids (ballast, firewater, potable water), and possibly process-related equipment for flow assurance. Winterization requirements are also important for HVAC (heating, ventilation, and air conditioning) air intakes to accommodate snow accumulation.

**Materials.** Both steel and concrete are feasible construction materials. The extremely low ambient temperature, down to -50 degree Celsius, does introduce

additional requirements for the steel qualities to be used, but this can be accommodated with existing steel grades. For concrete, the existing “standard” offshore quality (grades B55 or B60) is documented to have acceptable performance in the low temperature.

**Construction, Transport, Installation.** Alaska construction of GBS-type platforms has so far not been considered practical due the unavailability of local fabrication yards and locations having suitable water depth for construction. A main differentiator between a concrete and steel GBS would be that the steel version most likely will require some additional solid ballast to obtain sufficient on-bottom weight to be able to resist the ice load.

Towing a platform (substructure only or complete platform) is an established practice. A number of complete GBS platforms, the majority being multi-legged with topsides installed, have been wet-towed to final location and installed. (GBS construction and towing examples are shown in Figure 6-18.) A challenge foreseen for Alaska is the limited ice-free season, which will require good operational logistics management to enable completion of all operations including installation of ballast and scour protection within the available installation period. The wet-towing distance from a potential construction site in Asia to the Beaufort and Chukchi Seas is relatively long, but feasible. Shallow water along the towing route in the Bering Sea must be considered, depending on the tow draft of the GBS.



Photo: ExxonMobil Canada.



Photo: Shell.



Photo: Hibernia Management and Development Company.

**Figure 6-18.** Gravity-Based Structure Construction and Towing Examples (l-r: Hebron platform, Sakhalin-2 concrete platform, and Hibernia platform)

Offshore (or very often nearshore) mating of topsides and substructure is the preferred method because this will reduce the activities at the final location significantly. However, if there is no deep-water area available allowing a mating, an offshore float-over at the final location, as was performed for the last three Sakhalin platforms, is feasible.

**Decommissioning.** The basic requirement when designing a GBS substructure is that it should be possible to remove it when the field life has come to an end. This has been the case for large GBS structures designed and built for the past 30 years in the North Sea. Examples are the Frigg Field Center at the border between Norway and UK in the North Sea and the Ekofisk Tank in the Norwegian sector of the North Sea.

## Prudent Development Context

Development drilling and production platforms allow for year-round drilling and processing of produced hydrocarbons in the Arctic environment. The platform provides protection of equipment and people from the unique aspects of the Arctic environment including sea ice and cold temperatures. ISO 19906 and other established design codes and standards provide the basis for ensuring a safe and reliable design. Potential environmental impacts include (1) marine sound, (2) disposition of produced liquids and solids (e.g., cuttings), and (3) air emissions. These can be reduced through design (e.g., insulation and rotating equipment isolation and emission control equipment) or eliminated through reinjection wells.

Prudent development challenges of logistics to/from the platform during routine operations and Escape, Evacuation, and Rescue in the event of an emergency, while not related to development drilling and production platforms, can be addressed via reduced platform manning. Technologies to enable reduced manning fall into the general category of topsides design and include automation, robotics, and instrumentation.

The cost and construction time of a GBS platform in the U.S. Arctic will be higher relative to similar North Sea structures due to the need for winterization, ability to handle large ice loads which typically translates into greater mass, consumables storage, remote fabrication, remote and potentially multi-

season installation, and waste handling. Data regarding the ice environment is important to ensure cost effective and fit-for-purpose design to facilitate commercial development.

## Recent and Ongoing Research Activities by Industry, Academia, and/or Governments

**Fixed Structures.** Significant enhancement of ice-structure interaction technology has occurred post-2008 via industry and government sponsored JIPs (Joint Industry Projects). These include: SILS (Sea Ice Loads Software) by Newfoundland-based company C-CORE; ISO 19906 implementation guidance by DNV (industry JIP); re-analysis of 1986 Molikpaq multi-year ice loading events by an expert consortium led by the National Research Council of Canada's Canadian Hydraulics Centre; and a project to develop an engineering model to predict ice induced vibration by Olaf Olsen. Details on each can be found in Topic Paper 6-5 (see Appendix D). The U.S. government through the Department of the Interior's Bureau of Safety and Environmental Enforcement (BSEE) participated in the DNV JIP. Most offshore contractors have new design concepts for Arctic fixed platforms to work in a variety of ice conditions. The enhancements represented by the new designs will be captured when economic discoveries are made to justify their construction.

**Materials.** Activities are ongoing to further develop lightweight concrete to increase the ductility, especially at low temperatures. This quality could be an alternative if the minimum platform draft for tow and/or installation is an issue. These include a SINTEF-led JIP having the objective to establish criteria and solutions for safe and cost-effective application of materials for hydrocarbon exploration and development in Arctic regions.

**Floating Structures.** ISO 19906 covers floating structures in ice; however, the available design guidance is limited due to the lack of experience with floating structures. Key issues were summarized as part of Barents 2020 Phase 4,<sup>25</sup> which was an industry-government study. New capability to address the acknowledged limitations are the subject of ongoing improvement initiatives with focus on ice load and structure response prediction, station-keeping in ice, and ice management. Organizations involved in

this work include academic and scientific institutions (e.g., NTNU, Memorial, TU-Delft, Marin, and HSVA), specialist contractors (e.g., AKAC and Global Maritime), Classification Societies (DNV and ABS), and industry trade organizations (e.g., IOGP and PRNL).

**New/Updated Standards.** Efforts are underway to update ISO 19906 as well as develop new Arctic standards in the areas of (1) working environment, (2) escape, evacuation and rescue, (3) environmental monitoring, (4) ice management, (5) Arctic materials, and (6) physical environment for Arctic operations. The latter fall under the relatively new ISO/TC67 Subcommittee 8 on Arctic Operations that was a direct outgrowth from Barents 2020.

## Technology/Capability Enhancement Opportunities

Key technology/capability enhancement opportunities for development drilling/production platforms include:

- Reduced offshore manning through demonstration of full system integration of automation, monitoring, and telemetry technologies for remote operation.
- A key factor in advancing design practice has been measurement and monitoring of structure loads and causal ice features. This is an area for further technology development especially in light of the significant advancements that have been made in sensing technologies including fiber optics, etc. Installation of advanced sensors on future platforms offers opportunities to further expand industry's database of full-scale load measurements in ice.

Other opportunities, seen principally as optimization, include:

- Characterization and mitigation of platform-related marine sound
- Optimization of winterization and icing prevention technology
- Cost effective steels and improved qualification procedures for structural applications at temperatures below -45 degrees Celsius
- Designs to optimize single-season topsides matting and adaptability of topsides facilities for future modifications

- Improved low-temperature ductility of lightweight concrete.

## PERSONNEL SAFETY

Protection of the health and safety of its workforce is the first priority in the oil and gas industry. This section reviews issues related to emergency evacuation of crew from an offshore asset, vehicle, or vessel.

Because the terms escape, evacuation, and rescue are not used consistently throughout the world, their definitions as used in the context of this study are consistent with the Arctic Offshore Structures Standard<sup>26</sup> and are provided below.

**Escape** Act of personnel moving away from a hazardous event to a place on the installation where its effects are reduced or removed.

**Evacuation** Planned precautionary and emergency method of moving personnel from the installation (muster station or Temporary Refuge) to a safe distance beyond the immediate or potential hazard zone, usually off the installation.

**Rescue** Process by which persons entering the sea or reaching the ice surface, directly to a standby vessel, in an evacuation craft or by other means, are subsequently retrieved to a place where medical assistance is typically available. Includes survival and recovery components.

## Unique Aspects of Application in an Arctic Environment

The Arctic offshore environment can profoundly influence the design, operation, maintenance, and success of any EER system, necessitating that the full range of physical environment conditions be accounted for when developing and implementing an EER plan.<sup>27,28,29,30</sup> Consequently, the full range of physical environmental conditions possible at the offshore installation, as well as between the shore base and the installation, need to be taken into account when developing and implementing the EER plan.<sup>31,32</sup> Ice-related factors affecting the types of EER systems that could be used in different Arctic offshore settings

include ice concentration, ice drift speed and direction, ice thickness, ice floe size, ice roughness, ice pressure occurrence, joint ice and wave conditions, and fall freeze-up and spring break-up conditions. The nature of the interactions expected between the ambient ice cover and any Arctic offshore installation is another important aspect that must be accounted for in EER system design. The range of ice-structure interaction factors affecting the type of EER system best suited to a fixed or floating offshore installation include: ice conditions immediately adjacent to the installation such as the presence of grounded or floating ice rubble, ice-failure processes around the platform in moving ice, and the possible presence of a down-drift wake.<sup>33,34,35,36</sup>

The presence of sea ice at the installation (and icebergs and ice islands if applicable) can significantly influence the reliability and performance of different evacuation and rescue systems. Solutions for evacuation and rescue must account for survivability of systems in open water and waves, in various ice-wave combinations, between floes in pack ice, on a solid ice surface, and in the presence of ice rubble. Other factors associated with the Arctic include, but are not limited to: sea spray and atmospheric icing, low air temperatures, high winds and wind chill, poor visibility, prolonged darkness, the effects of blowing snow, and fog.

An ideal evacuation system for ice-covered waters is one that allows installation personnel to abandon the facility in an orderly manner in response to an emergency under all anticipated ice and sea conditions, and to proceed to a safe distance from the disabled facility to await rescue.<sup>37</sup> Most conventional evacuation methods employed in open water elsewhere in the world would have serious limitations in the presence of ice and simply may not be viable. For instance, while survivability in the winter Arctic environment may demand a faster recovery of evacuees, the most effective open water rescue methods may be adversely impacted by ice, darkness, and extreme temperatures. Consequently, the effects of cold air and water temperatures on survival time and potentially longer response times due to remoteness and/or ice conditions necessitate a greater reliance on dry evacuation systems whereby evacuees transfer from the mode of evacuation directly to the mode of rescue without entering the sea.



Photo: G. Timco and I. Morin.

**Figure 6-19.** Example Ice Damage Zone at the SSDC Platform in the Beaufort Sea

Ice rubble may have a major impact on the winter EER strategy. As an ice floe or an ice sheet impacts a structure, it is broken into smaller fragments referred to as ice rubble. Early in the ice loading event, ice rubble drifts past the structure. The distance from the structure to the ice that was deformed as a result of its interaction with the structure is referred to as the ice damage zone.<sup>38,39</sup> The ice damage zone width varies in response to factors including the ice thickness, ice failure mode, and ice drift velocity. Additionally, the authors (referenced above) reported that the ice damage zone widths can vary depending on structure type and that 10 to 20 m widths were not uncommon. An example grounded ice rubble field is shown in Figure 6-19. Such ice rubble fields can be hundreds of meters in extent, with sail heights in the range of 10 to 20 m in places, and can pose significant challenges to evacuation systems.

## History of Technology Development and Application in Arctic Conditions

Improvements to EER in open water areas have been made over the past several decades, driven largely in response to major loss of life and/or asset incidents (such as Ocean Ranger,<sup>40</sup> Piper Alpha,<sup>41</sup> Petrobras 36,<sup>42</sup> and Deepwater Horizon<sup>43</sup>). Due to limited activity, less effort has gone into improving EER systems and procedures suitable for offshore environments where sea ice persists for at least a portion of the year.<sup>44</sup> With the recent resurgence of commercial shipping and oil and gas industry interest in the Arctic offshore, Arctic EER is now receiving more attention. However, the relatively limited commercial market reduces

the manufacturers' incentive to develop highly specialized Arctic EER systems as compared to ongoing research and development (R&D) initiatives aimed at improving open water systems.

In the early to mid-1980s, bottom-founded exploration drilling structures were first deployed in the Alaskan and Canadian Beaufort Sea, where dynamic pack ice conditions were experienced throughout the year. More recently, offshore petroleum operations have moved into regions like the Sea of Okhotsk offshore Sakhalin Island and the Kara and North Caspian Seas where dynamic sea ice conditions also occur. Future Alaskan offshore exploration and development is planned for the U.S. Chukchi and Beaufort Seas where highly mobile pack ice is a common occurrence for much of the year.

### Current State of the Technology

A number of Arctic offshore EER systems have been developed and are currently employed in a range of ice and metocean environments around the world. These EER systems have been designed to account for the sea ice, metocean, and major credible incident scenarios specific to the region deployed and to the installation.

The harsh Arctic offshore environment poses several challenges to EER system performance. There currently does not exist one, single, universal evacuation method that would be suitable for evacuation in the full spectrum of environmental, metocean, and ice conditions under all credible incident scenarios.<sup>45</sup>

In cold regions, the EER strategy for the open water season can rely heavily on the use of existing technology. However, for the most part, these conventional open water EER systems and strategies, even in modified form, can only cope with a relatively limited range of sea ice regimes. Therefore in the interim, multiple, diverse means of evacuation, including modifications of open water systems for use in ice, are utilized to ensure that at least one method is available under the full range of environmental conditions, and incident scenarios are required to form a safe and credible EER system.

Any EER strategy must account for the site-specific environmental conditions that persist in the particular region of interest.<sup>46</sup> For example, rudimentary EER measures can be used for low freeboard structures in stable winter sea ice conditions. In some instances, the EER strategy under such relatively predictable winter conditions could look similar to that for land based drilling operations and may potentially include a provision to evacuate to the surrounding ice cover along a prepared path over the ice to an intermediate place of safety beyond the hazard zone.<sup>47,48,49,50,51</sup> In contrast, an effective winter EER strategy for a platform operating in an area of dynamic pack ice may look very different.

A few systems have been specifically designed for applications in ice-cover scenarios. These include the ARKTOS survival craft,<sup>52</sup> the Ice Breaking Emergency Evacuation Vessel (IBEEV) (see Figures 6-20 and 6-21), and the full-scale prototype Seascope System



Photo: W. Spring.

**Figure 6-20.** ARKTOS Evacuation Craft



Photo: Remontowa Shiprepair Yard.

**Figure 6-21.** Ice Breaking Emergency Evacuation Vessel

of evacuation TEMPSC (Totally Enclosed Motor Propelled Survival Craft) with a conceptual articulated deployment arm. The limited availability of Arctic evacuation systems reflects in part the relatively limited market that has existed to date. It also reflects the challenge of designing a single evacuation system suited for a diverse range of ice and open water conditions.

The capabilities of evacuation systems for use in ice-covered waters have been reviewed in a number of recent studies.<sup>53,54,55,56,57,58</sup> While acknowledging that advancements have been made, the authors also identify a number of technological constraints related to EER systems, especially with regard to applying the strategy to dynamic ice environments. These limitations are largely associated with evacuating during the Arctic shoulder seasons (i.e., during the freeze-up and break-up periods) when very thin new ice and melting floes predominate and from high-freeboard structures in dynamic pack ice.

In addition to recent technology advances, a major initiative to address Arctic offshore EER involved the development of the new ISO 19906 Design Standard. This standard provides the oil and gas industry with a coherent and consistent definition of methodologies to design, analyze, and assess Arctic offshore structures worldwide, and is expected to replace existing standards and guidelines. ISO 19906 emphasizes that the EER strategy be an integral part of the platform design and operations. The standard's objective is to ensure that offshore structures, deployed where Arctic conditions prevail, provide an appropriate level of reliability with respect to personnel safety, environmental protection, and the asset.<sup>59</sup> The standard addresses EER design requirements that are largely performance-based and also provides background and guidance on the use of the document. For evacuation in particular, the ISO Standard instructs that the same level of safety and reliability be achieved for personnel evacuations (and EER systems) on offshore platforms year-round.

## Prudent Development Context

Because the probability of having to abandon a manned offshore structure or vessel due to a major incident cannot be reduced to zero, a robust EER system is of paramount importance to protect offshore personnel. The EER system must function under the

full range of environmental conditions, including the ice conditions that the installation will be subjected to. As previously discussed, there is currently no *single* evacuation system that can be used in the full range of physical environment and evacuation scenarios anticipated for a high-Arctic installation. Hence, multiple systems are required, which are costly. For example, the operational costs of a standby ice management icebreaker over the design life of an offshore facility could be in the \$1 to \$2 billion range.

In instances where there are multiple offshore installations, standby icebreakers may well have to be stationed at each installation during the winter (if ice management is integral to the success of the evacuation system) due to the longer transit times in ice. Consequently, the increased costs associated with a robust EER strategy can affect the economics of developing some oil and gas fields.

## Recent and Ongoing Research Activities

A number of recommendations for improvements to EER systems were made in the Cullen Report<sup>60</sup> and by the Royal Commission<sup>61</sup> in response to loss of life incidents on the Piper Alpha and Ocean Ranger, respectively, which have led to improvements in open water EER capability. By contrast, a limited number of new evacuation systems have been designed and purpose-built for in-ice applications or systematically evaluated and tested in different sea ice conditions. That said, there are a number of recent and ongoing, noteworthy research and development initiatives inspired by renewed interest in Arctic development that include the following:

- A Canadian Panel for Energy Research Development (PERD) funded effort to pursue and evaluate viable EER systems for use in the Canadian Beaufort Sea<sup>62</sup>
- A Newfoundland, Canada R&D effort (via PRNL) to design, construct, and test an ice strengthened lifeboat in a wide range of sea ice conditions
- A Canadian PERD-funded initiative to assess the use and limitations of direct support vessel applications for personnel evacuations from platforms operating in ice environments
- A Joint Industry Study to assess the capabilities of a conventional lifeboat with the aim of ultimately

designing a TEMPSC with a “Fram-shaped” hull designed to resist high ice forces by rising out of the ice (Figure 6-22)

- A Joint Industry Study with Seascope to design an articulated lifeboat launching arm (and an ice enhanced TEMPSC) designed to place a TEMPSC on an ice cover or in the sea beyond the hazard zone
- The development and implementation of EER systems in the northern Caspian Sea, including the IBEEV and ARKTOS evacuation crafts (Figures 6-20 and 6-21)
- Refinements to the ARKTOS evacuation craft as part of its use at Northstar Island in the Alaskan Beaufort Sea, particularly during the freeze-up period
- A Joint Industry Study to modify the design of the Viking chute to allow deployment onto the deck of a standby icebreaker and/or onto the ice
- A Joint Industry Study to assess the performance of aviation and marine exposure suits
- Field measurements of local ice impact loads on a full-scale TEMPSC moving through an ice choked channel in a fresh water pond in Newfoundland.

In addition to the aforementioned studies, industry has undertaken R&D initiatives aimed at modifying conventional open water EER appliances to extend their capabilities in sea ice. Examples include the following:

- Ice characterization and risk studies carried out to identify and verify the power and station-keeping requirements for the Orlan Platform standby icebreaker offshore Sakhalin Island. The icebreaker proactively maintains a clear path through the ice rubble collar to the platform to enable launch of the TEMPSCs and a chute system directly to the vessel deck.
- Studies performed on the flat-bottom keel Survival Systems Inc. TEMPSCs to evaluate design modifications that enabled launch directly to a standby icebreaker vessel deck and to the ice, employing a “cushion mat” and slower winch descent speed. Additionally, winterization enhancement studies were carried out resulting in the design of shelters placed over the TEMPSC winch and canopy to reduce the amount of sea spray and atmospheric



Photo: Fleet Technologies.

**Figure 6-22.** *Lifeboat Ice Interaction Study of Craft Deployment and Recovery Icebreaker and Lifeboat*

icing and snow buildup, the use of low temperature lubricants and provision for fuel additives and the addition of cabin heaters and a coxswain window fan.

- The Viking SES-2 Arctic chute underwent design modifications employing a slower winch descent rate, a rail launch system to store the system behind the wave deflector when not in use, and other enhancements allowing launch to a vessel deck and/or to the ice.

### **Technology/Capability Enhancement Opportunities**

EER R&D initiatives are summarized below. Given that the greatest challenges to EER are associated with limitations in the evacuation and rescue areas, the focus of the R&D initiatives is on these two components.

- **Ice Capable Arctic Evacuation Craft.** This R&D initiative would include the design, construction,

and evaluation of a full-scale prototype craft capable of successful evacuation in a greater range of sea ice conditions than current TEMPSCs. It would also include an assessment of the requirements of ice management support of the craft in scenarios where this type of support is needed.

- **Mobile Arctic Evacuation Craft with an Enhanced Deployment System.** Strategies that can provide a successful means of evacuation independent of off-installation support are generally preferred as the primary means of evacuation compared to an evacuation strategy that relies for example, on the assistance of a standby vessel. A mobile Arctic evacuation craft with an enhanced deployment system R&D initiative would be to develop an evacuation craft with mobility sufficient to transit beyond the hazard zone to an intermediate point of safety (e.g., onto an ice floe) without the need for ice-breaker assistance over/through a range of stationary and dynamic sea ice and metocean conditions, including rough ice, ice rubble, and water. This R&D initiative would include the design, construction, and evaluation of a full-scale prototype craft capable of successful evacuation from low and high freeboard offshore installations in a greater range of sea ice and open water conditions than current technology (e.g., the ARKTOS). Craft mobility would need to be such that it could transit through all combinations of ice and water that might exist near an installation to reach a point beyond which the installation hazards pose no threat. The need for a deployment system capable of launching the craft beyond the ice damage zone from low and high freeboard offshore installations would also be evaluated as part of this effort in the event mobility across ice and/or water was impaired to the extent that evacuation success criteria were not met.
- **Direct Transfer Methods for Personnel Between Installation and Standby Vessel.** Simple, relatively low-tech EER strategies utilizing systems with which installation personnel are already familiar are preferred, as they reduce the training requirements and ultimately the success of EER under an actual incident scenario. Moreover, evacuation systems that transition directly to the means of rescue without crossing over or transiting through the sea ice or having to first enter the sea are desirable because rescue is achieved without evacuees having to survive for a period of time outside the hazard zone. This R&D initiative involving

direct transfer methods for personnel between the installation and a support vessel would improve upon any direct transfer methods currently available. Methods could include gangways, chutes or some combination thereof. These systems could originate either from the vessel or the installation.

This R&D initiative would include the design, construction, and evaluation of a full-scale prototype direct personnel transfer system for use over a range of installation deck heights. Note that for this evacuation and rescue strategy to be viable, the attendant vessel would require station-keeping capability in the range of sea ice and metocean conditions anticipated, over the anticipated duration of the transfer operation. A range of vertical and horizontal motion design criteria at the installation or on the vessel would need to be agreed to as part of the system design.

- **Education and Training Simulator.** The winter Arctic environment poses challenges to deployment of evacuation and rescue systems for the purpose of training and drills required to maintain personnel competency in response to an emergency. Whereas damage to lifesaving appliances may be an acceptable outcome when deployed under emergency conditions, provided EER success is not compromised, damage to EER systems as a result of training exercises may compromise the operational readiness of these systems for use in an emergency. Additionally, replacement of lifesaving appliances damaged during drills or training exercises may have long lead times and be cost prohibitive. Finally, practical training may not be possible during the winter due to increased exposure to the elements by the trainees. The education and training simulator R&D initiative would allow installation personnel the ability to maintain competency in the use of EER equipment and procedures.

This R&D initiative would include the development of an EER simulator that can provide close to “real life” training without the risks involved in actual deployment of the lifesaving appliances onboard the installation and support vessel (if part of the EER strategy).

- **Situational Awareness.** In some regions and/or at certain times of the year, ice conditions at an offshore installation can vary widely over relatively short periods of time. The success of the EER

system may be challenged more so by certain ice environments than by others. This may include both the performance of the evacuation system(s) as well as the ability to rescue evacuees once they have abandoned the installation. Upon sounding of the emergency alarm, installation personnel generally head to a designated Temporary Refuge, which provides protection while the severity of the incident is assessed and the incident response managed. The refuge is designed to withstand the effects of the incident for a prescribed period (i.e., the impairment time) until such time the incident is either brought under control or a decision to abandon the installation is made.

To address the potentially longer evacuation times in ice and advantages of selecting the optimum time to evacuate when ice conditions are less onerous, one EER strategy is to design a Temporary Refuge with a longer impairment time. To aid the evacuation decision-making process, information regarding ice conditions at and up-drift of the installation as well as an assessment of the evacuation route integrity is needed. The situational awareness R&D initiative would result in the incorporation of real-time situational awareness capability into the offshore installation's extended life Temporary Refuge design, such that the optimum timing for evacuation (if needed) can be made as the environmental conditions and incident severity dictate.

This R&D initiative would entail an assessment of on- and off-installation monitoring techniques, including the provision for drones to provide information on existing and oncoming ice conditions (both local and far-field) that could impact evacuation and/or rescue success as well as the viability of evacuation routes to the evacuation points.

## **OFFSHORE PIPELINES AND SUBSEA INSTALLATIONS**

Offshore pipelines may be used to transport produced fluids from an Arctic offshore production platform to an onshore facility for treatment and further transport via overland pipeline or tanker to market. Offshore pipelines may also be used for in-field transfer between platforms, from subsea wellheads to a production platform, or to carry fluids from a production platform to a nearby offloading buoy for export by tanker. Finally, offshore pipelines may be used to

export production from subsea wellheads directly to shore. Subsea wellheads and production facilities are important technologies for deeper water Arctic developments because they can be tied back to shore or a fixed platform in shallower water, and hence eliminate the need for floating production facilities in ice. Subsea wellheads may also be used to minimize the number of platforms required for drill centers in fields with distributed reserves.

### **Unique Aspects of Application in an Arctic Environment**

There are a number of unique aspects of pipeline and subsea installation and operations that differentiate the offshore Arctic environment from an open water environment. Key Arctic offshore factors (not present in every circumstance) include (1) interaction of ice keels with the seafloor and subsea facilities, (2) presence of a continuous sea ice cover during the winter, (3) cold ambient temperature, (4) finite duration of open water season, (5) strudel scour during thaw season, and (6) presence of near-surface permafrost in the pipeline burial zone.

The most important design concern for offshore Arctic pipelines and subsea facilities is protection from interaction with ice. In the U.S. Arctic waters, the keels of first-year and multi-year pressure ridges and occasional ice island fragments cut gouges up to several kilometers long into the seafloor, as is well documented by seafloor bathymetric surveys.<sup>63,64</sup> Figure 6-23 shows a schematic of the ice gouge process. First-year ice ridge keels consist of relatively lightly consolidated blocks of ice rubble, while multi-year ridge keels and ice islands consist of more consolidated, stronger ice. Due to the mechanics of their formation (pushing of buoyant fragments of broken ice below the ice sheet), the maximum extent to which first- and multi-year ice keels extend beneath the sea surface is about 35 to 40 meters. There is some evidence that a rare keel may reach deeper. For instance, the Geologic Survey of Canada reports an extensive, multi-year database for the Canadian Beaufort Sea wherein the deepest water depth for what is classified as a *modern* seafloor gouge is 52 meters (from the 2008 repeat survey).<sup>65</sup> Icebergs, which are not present in the U.S. Arctic, can also produce gouging, and experience from offshore locations with icebergs contributes to the overall design practice.

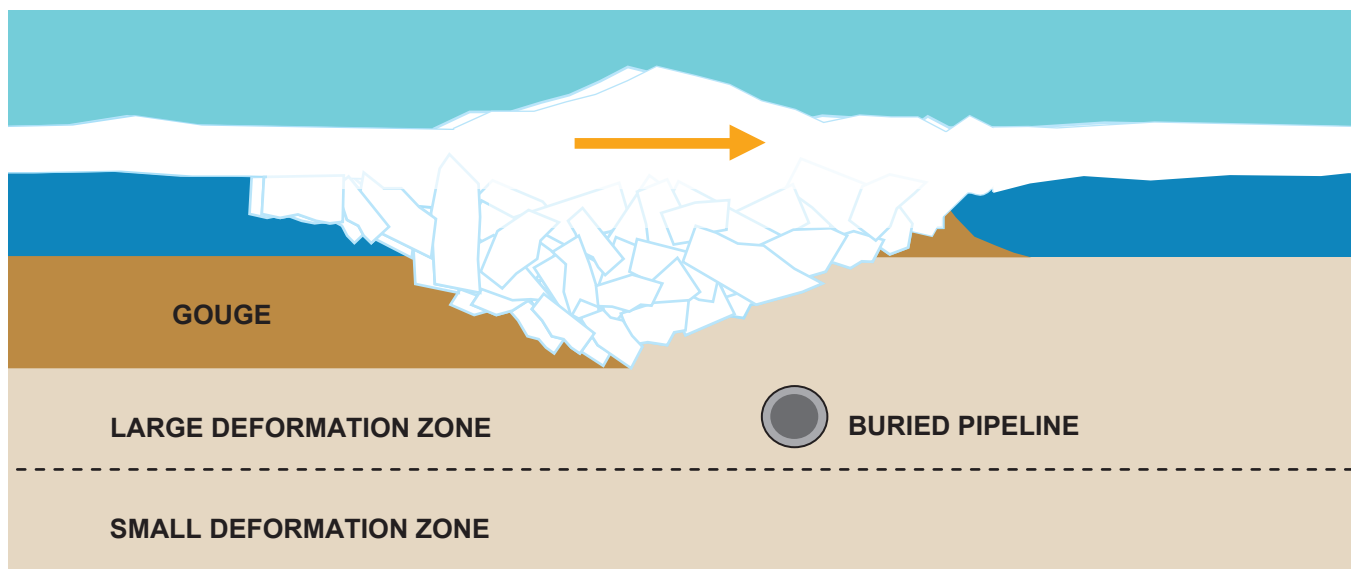

Source: ExxonMobil.

**Figure 6-23.** *Ice Gouging Process*

Any subsea facilities located in water depths within the reach of ice keels must be protected from interaction with the ice. For seafloor pipelines, this usually means burial below the depth of gouging ice, and for subsea wellheads and production templates, this could mean use of an engineered protection structure and/or placement in an excavation or buried caisson that extends below the seafloor. In some locations, deep trenching can be challenged by rock outcrops or presence of rocks and boulders.

Buried pipelines installed in cold ambient temperatures must be designed to prevent upheaval buckling due to high thermal expansion when the pipe is later heated by production fluids. All Arctic pipelines could be subject to flow assurance issues (gas hydrate formation or solidification of waxes in crude oil) because of the cold ambient temperatures, but both of these issues are also common to all deepwater pipelines where seawater temperature is just above freezing.

During the winter months in most Arctic offshore areas, sea ice grows to 1.5 to 2.2 meters thickness and covers 90+% of the sea surface. Beyond the landfast ice edge (usually beyond the 15 to 20 meter water depth contour in the U.S. Arctic), the sea ice is dynamic and may drift up to tens of kilometers per day. In most years in the U.S. Arctic, there is an open water season that varies depending on location and year from about 2 to 4 months. The short open water

season limits the time available to install pipelines, maintain subsea facilities, or perform workovers of subsea wells, if these operations cannot be conducted in the presence of ice. Pipeline installation in the presence of thick, drifting sea ice is not possible with current technology due to difficulty of maintaining station and heading of the pipe lay vessel. Hence, for a very long pipeline, installation may have to span multiple open water seasons, which is a significant cost factor for offshore Arctic pipelines. Rapid detection of oil leaks under the ice is also important to avoid a long-term release.

Subsea permafrost zones, remnants from the last ice age, are relatively common in shallow water in the Arctic, although the top of permafrost often lies many meters below the seabed due to gradual heating from the overlying seawater. In some offshore Arctic locations, however, shallow permafrost exists near the seabed. This permafrost would be susceptible to thawing from an uninsulated product line and hence, and in addition to being difficult to trench through, could also be the source of significant potential settlement of the pipe. In areas where the subsea permafrost is discontinuous, high differential settlements can occur as the pipeline settles in thawed permafrost zones and remains stable in nonpermafrost zones. These differential settlements can induce significant strains in the pipeline. While no commercially operating offshore pipelines have been installed in

permafrost, shoreline crossings in Alaska have been insulated to avoid thawing of nearby or underlying permafrost.

## History of Technology Development and Application in Arctic Conditions

What follows are brief descriptions of installed Arctic subsea pipelines. Extensive descriptions can be found in Palmer and Croasdale<sup>66</sup> along with details of the overall Arctic pipeline technology development. These descriptions illustrate the technology, capabilities, and experience that have been developed in the United States and elsewhere that are applicable to future U.S. Arctic offshore hydrocarbon developments.

**Drake Pipeline (installed 1978).** The first major subsea hydrocarbon-carrying pipeline to be installed in an ice environment in the Western Hemisphere was by Panarctic Oils in the Drake field in 1978. This was a 1.1 km demonstration pipeline for transport of gas from the Drake 76 well to Melville Island. The pipeline consisted of a pipe-in-pipe bundle of two 6-inch pipes plus other control umbilicals. The pipe-in-pipe concept was used to introduce a refrigerant to keep the soil around the buried pipe frozen. The shore approach was constructed by directional boring, and the offshore portion beyond the drilled-in section was buried to a depth of 1.5 meters by trenching from a floating vessel.

**Alaska Nearshore (installed 2000, 2007, 2009).** Northstar, Oooguruk, and Nikaitchuq are all shallow

water offshore developments in the Beaufort Sea that consist of a gravel drilling island with buried shallow-water pipelines to carry produced fluids to shore. They were all constructed using a conventional onshore-type methodology, which involved excavation from thickened landfast ice using long-reach track hoes as shown in Figure 6-24.

The Northstar Production Island is located about 10 km offshore in the U.S. Beaufort Sea. The oil export line was installed in the winter of 2000. It consists of two bundled 10-inch pipes along with a hydrocarbon-permeable tubing that was included as a test system for pipeline leak monitoring. Design burial depths of 1.8 to 2.1 m were established based on multiple seasons of surveys of seafloor gouges in the area. The Oooguruk pipeline was installed in 2007 in up to about 2-m water depth. It consisted of bundled 12-inch production line, 6-inch gas lift and injection flowline, and a heating fuel line, all contained within a 16-inch outer pipe. The Nikaitchuq pipeline was constructed in 2009 in up to 3 m water depth. It is 5.6 km long and consists of a pipeline bundle with a 14-inch pipe-in-pipe production flowline in an 18-inch carrier, a 12-inch insulated water injection line, 6-inch spare line, and a 2-inch diesel line. Due to natural sheltering and very shallow water, gouging for the Oooguruk and Nikaitchuq pipelines is a minor issue.

**Sakhalin Island Export Pipelines (installed 2005-2013).** The Sakhalin-1 project installed export pipelines from offshore gravity-based platforms to carry produced fluids to onshore treatment facilities



Photo: INTECSEA.

**Figure 6-24.** Excavation and Installation of Northstar Pipeline Bundle from Atop the Ice

and injection water back to the platform. The pipelines were concrete-weight-coated and of various diameters up to 28 inches. They were installed during the open water season, which for this location is generally 6 months. Because there were no existing international standards at the time, a strain-based design methodology was used in the Project Specific Design Code developed by the project in conjunction with Russian design institutes and with approval of Russian design authorities.<sup>67</sup> With the exception of areas where water depth exceeded about 30 m (roughly maximum design ice keel depth), the pipelines were buried to a depth that exceeded the design ice keel gouge depth.

Design burial depths were based on extrapolation of hazard curves developed from repeat seafloor gouge surveys conducted along the pipeline routes over a period of several years. The designs also accounted for potential seafloor erosion over the life of the pipelines. Shore approaches through the surf erosion zone and through the dynamic shoreline were constructed by deep trenching in a cofferdam-supported section. These pipelines have been in service since 2005 without incident or reported contact with gouging ice. The latest is the pipeline (installed in 2011) connecting the Berkut platform in 35 m water depth to the Chayvo onshore production facilities.

The Sakhalin-2 project has offshore pipelines totaling nearly 270 km in length connecting platforms in the Piltun-Astokhskoye and Lunskoye fields with the onshore oil and gas pipeline systems to the Onshore Processing Facility/LNG plant at the southern end of Sakhalin Island. Four separate 14-inch concrete-weight-coated pipelines deliver crude oil and dry gas from two platforms to an onshore manifold at the Chayvo landfall. Two 30-inch multiphase concrete-weight-coated pipelines run to the Lunskoye landfall over an offshore distance of approximately 15 km.

Sakhalin-2 pipeline design accounted for high strain capacity and extremes of ambient temperature. Significant portions of the offshore pipelines lie in water depths shallower than 32 m and therefore burial was required to protect them from ice gouge damage. Shore approaches through the surf erosion zone were constructed with extra-deep trenches, using major dredging equipment and cofferdams. These pipeline systems have been in service since 2009 without incident or reported contact with gouging ice. The pipeline systems are equipped with an

Atmos leak detection system and an oil spill blockage system.

***Varandey Oil Terminal Line (installed 2008).*** The Varandey offshore oil export terminal consists of a fixed or bottom-founded platform located 18 km from shore in about 21 meters water depth in the Russian Pechora Sea. The facility was installed in 2008. It is connected to onshore crude oil storage facilities via two 20-km, 36-inch pipelines that are buried with 1.5 meters cover for protection from potential first-year ice ridge keel gouges. A fleet of icebreaking tankers evacuate oil from the platform year-round. The Varandey pipelines were trenched using a trailing suction dredge and backfilled with barged-in sand.

***Baydaratskaya Bay Pipeline Crossing Project (installed 2008).*** The project consists of installation in the summer of 2008 of two 48-inch concrete-coated gas pipelines to carry product from the Bovanenkovaya and Harasawejskoje gas fields on the Yamal Peninsula, Russia, 68 km across the Baydaratskaya Bay in the southern Kara Sea. Water depth for the 40-km dredged portion varied between 9 and 23 meters. The pipeline was buried with a cover depth of 1.5 meters in a dredged trench and backfilled with dredged sandy borrow material from near the Ural coast. Preconstruction gouge surveys indicated deepest gouge depth of 1.0 meter. The construction extended into November, and based on published photographs, some of the floating operations may have been conducted in very thin newly grown sea ice.

***Terra Nova and White Rose Excavated Drill Centers (installed 2001, 2005).*** There are currently two operating floating production, storage, and offloading (FPSO) vessels on the Grand Banks offshore Newfoundland where there is potential for icebergs to gouge the seafloor. Terra Nova was installed in 2001 and White Rose in 2005. The subsea well templates for these FPSO developments are located within excavated pits in the seafloor, commonly known as excavated drill centers (Figure 6-25). The excavated drill centers were dredged with cutter suction dredging equipment in about 100 meters water depth to produce large pits that would allow the wellheads to remain below the level of the seafloor to protect from seafloor-gouging icebergs. Subsea flowlines for these fields are sacrificial—not buried, but instead designed to be flushed and isolated in the rare event that an iceberg threatens contact with them. The seafloor in the Grand Banks area contains hardpan and boulders,



Source: Husky Energy.

**Figure 6-25.** *Excavated Drill Centers for Protection of Subsea Wellheads*

rendering it very challenging to bury pipelines. As a consequence, there are not pipelines to shore and product is transferred to tankers for export.

## Current State of the Technology

As evidenced by the relatively large number of installed facilities that have been performing successfully for years, this category of E&D technology is well established. Design practice, installation methods, and integrity monitoring systems have been advanced significantly over the past several decades.

**Offshore Arctic Pipeline Design Practice.** Protection from damage due to contact by ice is the primary unique design requirement for Arctic offshore pipelines. Methods used for offshore Arctic pipeline design to date have been well documented by DNV<sup>68</sup> and will not be repeated herein. Design of offshore Arctic pipelines is discussed in section A.14.3.5.1 of ISO 19906. Design of pipelines subjected to potential ice interaction is also discussed in DNV OS-F101 and API RP2N (3rd edition will adopt ISO 19906). DNV OS F101 does not present an explicit methodology for the assessment of loads imposed on offshore Arctic pipelines, but does require ice load effects to be considered in areas with probable occurrence of ice gouging. C-CORE prepared a report for the U.S. Minerals

Management Service on design options for pipelines in the U.S. Chukchi and Beaufort Seas.<sup>69</sup>

Establishment of pipeline burial depth requirements requires consideration of three components:

1. No ice is allowed to contact the pipeline (i.e., the pipeline must be buried deeply enough to avoid any contact with the pipe by a defined, extreme gouge feature).
2. An additional burial allowance may be required to maintain design pipeline cover in the event of loss of cover due to seafloor erosional processes.
3. A further burial allowance may be required to avoid excessive pipeline strains from being induced by subgouge soil deformation.

With regard to the first component, the extreme gouging feature is commonly based on a design return interval meant to yield a specific target reliability against failure. It is determined primarily from an extrapolation of a gouge depth database collected over multiple seasons. It is determined based on the gouge depth distribution and the frequency of gouges that occur per kilometer of pipeline length per season. Gouge depth surveys are made during the open water season using multibeam sonar bathymetry measurement, which have accuracy on the order of 0.05 m. In some cases, seafloor gouges can become infilled by sediment, so infill allowances may be in order. In areas like the Beaufort Sea or Grand Banks, where gouges are not obliterated annually by seafloor lithodynamics, it can be very difficult to determine the age of measured gouges. Hence, repeated surveys over a period of years are required to estimate the frequency of gouging occurrence.

A subgouge deformation allowance is established based on an analysis of strain induced in the pipeline by soil deformations that occur for some depth below the gouging ice feature. The subgouge deformation profile below a gouging ice feature is estimated from principles of soil mechanics, and the deformation field is applied analytically to the pipe using various models from structural spring models to three-dimensional finite element methods.

In all design cases, the objective is to ensure that pipeline strains are limited to values that prevent rupture and leakage. Typically a two-tier design criterion is used wherein the strain in the pipe for an intermediate return interval event (say several hundred

years) is kept below a value that would lead to damage needing repair (i.e., a serviceability limit, but no leakage). The extreme performance limit is meant to limit pipeline strains from the extreme design ice gouge below a level that could lead to pipe rupture.

**Pipeline Installation.** The primary challenge for offshore Arctic pipelines is in attaining the required burial depth in an expeditious and economical manner. Based on the design considerations discussed above, required burial depths can be several meters of cover over top of pipe in the U.S. Beaufort and Chukchi Seas. There are various technologies available for trenching and burial of offshore pipelines. These include backhoe excavators in very shallow water, standard dredging equipment, pulled plow-type sleds, or even seafloor-crawling cutting and jetting excavators. The choice of appropriate equipment depends on the water depth, depth of trench required, and the type of seafloor soil conditions. The greatest challenges are associated with deeper water depths and hard or cemented seafloor soils or soils containing large boulders.

Shoreline approaches and crossings in the Arctic can be particularly challenging if the shoreline soils consist of frozen permafrost. Arctic shorelines are susceptible to rapid erosion due to the melting of permafrost. Disturbance of the permafrost by excavation or the presence of a warm pipeline, can lead to accelerated erosion in the shoreline crossing area and potential exposure of the pipe. Shoreline approaches are constructed either by tunneling, horizontal directional drilling, or direct excavation and backfill. Excavated shore crossings in permafrost areas have been over-excavated and backfilled with thaw stable material and also include thermal siphons to keep surrounding permafrost frozen. Excavated crossings usually involve the construction of a temporary cofferdam to maintain soil stability until pipe lay and backfilling are completed.

**Pipeline Tie-In and Subsea Wellhead/Equipment Protection from Ice Interaction.** As discussed previously, offshore Arctic pipelines are best protected in a sea ice environment by burial so that the seafloor soils shield it from gouging ice keel features. Pipeline tie-ins to bottom-founded gravity-based structures typically enter the platform above the seafloor. If the water depth is within range of ice interaction with the seafloor (say less than 40 meters), the tie-in spool is vulnerable to interaction by ice and hence requires

protection. Protection has commonly been achieved by structural tunnels and/or rock armament. Likewise, subsea wellheads and subsea production equipment requires protection when within range of interaction with sea ice ridge keels. Various subsea protection structures have been proposed, which typically involve embedded or partially embedded steel or concrete caissons or steel protection structures that extend above the seafloor. Such structures must be designed with sufficient foundation capacity to resist ice interaction without being displaced into the protected wellhead or subsea template.

Protection of subsea facilities from multi-year ice or ice island interaction involves significantly higher loads since the ice interacting with the structure can be much more competent than first-year ridge keels. In the Subsea Ice Risk Assessment and Mitigation Joint Industry Program (SIRAM JIP), C-CORE developed conceptual designs for wellhead protection structures for a Grand Banks free-drifting ice-berg environment.<sup>70</sup> More substantial designs may be needed for protection of wellheads or subsea facilities that are susceptible to interaction with ice islands or multi-year ice keels. The U.S. Arctic offshore would fall into the category of having potential interaction with ice islands and multi-year ice keels in water depths ranging from the landfast edge out to about 35 to 40 meters.

**Pipe-in-Pipe Designs.** Some of the offshore Arctic pipelines have been installed as pipe-in-pipe systems. In every case, the functionality of these pipe-in-pipe systems was to provide insulation, confine a bundle of pipes and umbilicals, or provide for pipe-platform relative movements at platform tie-ins. When not required for flow assurance purposes, pipe-in-pipe is not an effective, efficient, or economic system for increasing pipeline integrity against ice-induced damage, because it is only minimally effective in reducing local strains in the pipe material. Potential losses of inventory can best be managed through means such as pipeline geometry and isolation valves. The most reliable means for safeguarding against pipe damage is to bury the lines below the depth of extreme gouges and thereby avoid ice-pipe contact.

**Long-Term Monitoring of Subsea Pipelines and Production Facilities in the Arctic.** Routine surveillance of Arctic subsea pipelines can be challenged by the presence of ice cover. Consequently, most Arctic pipelines either constructed or proposed include provisions for

some form of enhanced leak detection so they can be shut-in quickly in the event of a breach and thereby minimize spilled product. Leak detection can range from computational differential flow and/or pressure measurements along a pipeline segment, continuous fiber optic lines, or hydrocarbon-permeable detection lines buried in the pipeline bundle to regular pipeline route surveys with underwater vehicles equipped with sensitive hydrocarbon detection instruments such as fluorimeters or mass spectrometers.<sup>71</sup> Emergency isolation valves could be located in strategic points along the pipeline (say at shore crossings) to allow the flow of product to be stopped in the event of a detected leak and to minimize the volume of product that might be released from a ruptured pipeline. The subsea facilities industry has been developing sensitive leak detection instrumentation that could be readily adopted for Arctic subsea applications.

In areas of active ice gouging, the seafloor can be re-surveyed periodically (if warranted, say, based on observations of unusual ice features) at the end of the ice season to inspect for seafloor erosion and to characterize any seafloor ice gouging that occurred during the winter. Ice gouge monitoring allows confirmation that gouges have not exceeded the design criteria and verification that there has been no potential for pipeline disturbance by ice. Vessel-mounted multibeam bathymetry surveys are conducted in a swath around the pipeline so that gouge depths can be measured and gouge frequency determined. The gouge survey might trigger a pipe deformation survey if any deep (i.e., design-level) gouges are observed crossing the pipeline.

Another potential method to monitor pipeline integrity in the event of an unexpected gouge event is to use deformation monitoring. Deformation monitoring is possible using a “smart” pigging device (e.g., geopig or caliper pig) capable of detecting changes in pipeline geometry and/or changes in pipe deformation or strain. Such surveys would typically be run upon completion of the ice season as discussed above.

## **Prudent Development Context**

With regard to human health and safety, offshore pipelines and subsea installations play a relatively minor role because there is minimal direct human exposure outside of potential crew exposure from gas line rupture near the platform tie-in. Offshore pipelines and subsea installations play a major role in the

prudent development dimension of environmental stewardship and sustainability because they are containment systems that provide environmental protection from spills stemming from ice interaction. This functionality is thoroughly addressed in the design process, which provides for industry-standard minimum safety margins. There is an additional minor environmental protection dimension associated with installation and operations, which involve potential for short-term ecological impacts due to the excavation of the seafloor for buried pipelines or subsea facilities and some long-term operations-related considerations such as marine sound emissions from subsea facilities. All of these factors are normally addressed in Environmental Impact Assessment processes.

Potential impact to local inhabitants is also minor and is associated with installation activities and shoreline crossings. Installation activities have the potential to temporarily impact seasonal migration paths of mammals important to subsistence hunting. Such impacts and their mitigation are also normally addressed in the Environmental Impact Assessment process. Improperly designed shoreline crossings have the potential to initiate or exacerbate shoreline erosion. This dimension is addressed in the design process.

This technology plays a major role in terms of costs and economics of Arctic development projects. Burial requirements make Arctic subsea pipelines more costly than their non-Arctic counterparts, and understanding of the ice environment is important to ensure cost effective design and protection. Installation can take multiple years due to the short open water construction season. The offshore pipeline challenge is exacerbated in the U.S. Arctic due to lack of availability of Jones Act-compliant vessels for seafloor excavation. If the Jones Act is to be applied to offshore pipe laying in Alaska, then an initial development would have to bear the high cost of constructing a Jones Act-compliant fleet of pipeline burial and installation vessels, which may not be commercially feasible.

## **Recent and Ongoing Research Activities**

***Burial Depth Requirements.*** Most of the recent and ongoing research work on pipeline burial relates to subgouge soil deformation and pipe strain prediction.

Large joint industry funded programs have been conducted since the mid-1990s to study the gouging process and associated soil deformations and induced strains in buried pipelines. These programs included the Pressure Ridge Ice Scour Experiment (PRISE) and Pipeline Ice Risk Assessment and Mitigation (PIRAM) JIPs, whose results have been extensively documented. Petroleum Research Newfoundland-Labrador (PRNL) is also progressing work using the Newfoundland-Labrador producer's research obligation funding in conjunction with Petroleum Research Canada with the intent to ultimately conduct large-scale gouge tests in prepared soil beds with embedded instrumented pipes. Scores of finite element modeling studies have been conducted by many academic and industry researchers to advance methods for prediction of pipe strain due to ice gouging. All of these are well documented in the previously referenced DNV study. This work has advanced significantly over the past 20 years and is reaching a fairly mature state of incremental improvements aimed more at improved economics versus enabling technology. For instance, the goal of the most recent work is to reduce pipeline burial depths and hence reduce the high cost of burial while maintaining target levels of reliability.

**Seafloor Gouge Surveys.** Seafloor surveys are discussed in more detail in topic papers developed for Chapter 5, "Characterization and Measurement of the Ice Environment." The need for historical datasets to help establish design criteria are site specific. Much work has been done with repeat seafloor gouge surveys in various areas to better understand the frequency of occurrence and depth distribution of ice gouges. The best work (from a perspective of long-term record of repeat surveys) has been performed by the Geologic Survey of Canada. Industry has conducted proprietary gouge surveys in most areas of interest for exploration and development. Since few datasets extend back more than a decade, additional repeat surveys will continue to improve the basis for design criteria and hence overall pipeline reliability.

**Pipeline Trenching Methods.** Since burial depth requirements in some theaters could be substantial (e.g., ~5 meters in the Beaufort Sea and Grand Banks and potentially 7 meters in the iceberg environment offshore West Greenland), some research has been conducted on improved trenching methods, both for trenches in deeper water iceberg environments and for deeper depth trenches. One of the Newfoundland-

Labrador research projects being stewarded by PRNL on behalf of the Newfoundland-Labrador producers has as its objective to develop an offshore pipeline trencher that can excavate to a depth of 8 meters in seafloor soils containing boulders and in water depths to 300 meters. This is a proprietary study that for some confidentiality period will belong to the sponsoring companies.

**Subsea Wellhead and Production Facilities Protection.** The primary work in this area has been conducted under the SIRAM JIP and focused mainly on protecting seafloor facilities from ice or iceberg contact using fabricated steel structures. This work, conducted by C-CORE, is documented in the previously cited Randall et al.<sup>72</sup>

## Technology/Capability Enhancement Opportunities

Due to a large body of work related to recent sub-sea pipelines installed in ice environments, current opportunities for research are mostly confined to cost saving as opposed to enabling—for example, shallower burial criteria, improved reliability, better leak monitoring instrumentation, and better trenching capability to deeper depths. An exception would be radically quicker pipe construction and installation methods that could allow installation in a single season. Depending on location and distance from shore, pipeline installation that takes numerous years to complete can be a significant barrier to commercial feasibility of a pipeline-based export strategy. Solutions would most likely require methods and equipment for installation of buried subsea pipelines in drifting pack ice.

An inventory of other areas where technology extensions would be useful (albeit probably not enabling) includes the following:

- Methods for age dating of seafloor gouges to distinguish between relic and modern gouges and hence help mitigate the need for burial depths that accommodate deep gouges that are not part of the modern record
- Pipeline trenching methods to more efficiently attain deep burial depths of 5+ meters that may be needed for some high-Arctic environments where multi-year ice ridge keels can interact with the seafloor and seafloor soils are soft

- Adaptation of new and emerging sensor technologies for enhanced leak detection and pipeline integrity monitoring
- Special designs for minimizing or avoiding product loss from a damaged pipeline
- Improved shoreline approaches to preclude permafrost thaw or accelerated erosion
- Improved ice gouge databases from repeat surveys in areas where data are sparse
- Improved understanding of subgouge deformation phenomena with respect to soil conditions and trench configuration
- Economic ice gouge protection structures for sub-sea wellheads and production facilities.

## OFFTAKE AND TANKERING

The use of tankers is well established as a means to transport hydrocarbons in ice-prone waters, as has been demonstrated with long experience in sub-Arctic areas such as the Baltic, Great Lakes and St. Lawrence River, Far East Russia, and in Cook Inlet Alaska, where navigation continues throughout the winter season. In addition, there have been regular fuel oil deliveries made to Arctic communities in North America and Russia for decades and a few pilot programs have been undertaken such as the Bent Horn oil export in Canada from 1985 to 1997. There is more limited, but growing experience with such tanker traffic, year-round, in the Arctic. Since the Oil Pollution Act of 1990, and further reinforced by international regulations, all tankers operating in the Arctic are required to be double skinned (i.e., no cargo oil is carried against the outside shell plating). In addition, the IMO Polar Code is expected to be fully in force by 2017, whereby ships operating in Arctic waters will be subject to regulations governing design (including a requirement for no pollutants against the shell), equipment (certificated against temperature), and operational aspects (recommendation of limitations for ice conditions versus ice class).

### Unique Aspects of Application in an Arctic Environment

Operation of tankers in a sea ice environment requires ice-classed vessels and potentially the aid of escort icebreakers to create a channel in the ice ahead of the tanker. Offloading of oil from an off-

shore platform to a tanker requires that the tanker be able to connect to the offloading line and maintain its position during the time it takes to transfer the product. The presence of drifting sea ice in an Arctic setting presents unique station-keeping challenges beyond those for open water environments, as the mooring system holding the tanker in position must be able to resist ice forces on the tanker hull. This is accomplished with the aid of an ice management system that reduces the size of incoming floes to maintain loads on the tanker that are within the capacity of the mooring system. The ice management system may also assist the tanker in maneuvering for hook-up and possibly weather-vaning to remain aligned with the ice drift direction. Offloading in the Arctic during winter months is particularly challenging as there may be thick ice cover with very high concentration of ice coverage. Brash ice accumulation from repeated icebreaking and artificial thickening of the ice due to refreezing under slow drift conditions presents additional challenge. The relatively short connection time of about 12 hours allows for some selectivity in ice and ice drift conditions in which to conduct tanker loading operations.

### History of Technology Development and Application in Arctic Conditions

**Tanker Loading and Navigating in Ice.** There is a long successful history over many decades of using tankers to transport hydrocarbons in ice-prone waters, such as the Great Lakes and St. Lawrence Seaway, Cook Inlet, Alaska, in the Baltic, and along the Northern Sea Route off Russia's northern coast. There have been some pilot programs in the Arctic such as the 1969-70 voyages of the SS *Manhattan* from the U.S. East Coast to the North Slope of Alaska<sup>73</sup> and the seasonal export of oil from the small Bent Horn field in the Canadian Arctic Archipelago.

The following paragraphs describe some of the recent experience with tanker offtake and transport in Arctic and sub-Arctic waters, which illustrate well the advanced state of the art of design, construction, and operation of the physical plant required.

**Modern Tanker Operations in Baltic Ice.** In 2001, the Finnish oil company Fortum ordered two 106,000 DWT (deadweight tons) double acting tankers from Sumitomo Heavy Industries to replace the company's older tankers that, because of their lower

ice class, could not deliver their cargo all the way to the refineries in western Finland due to traffic restrictions during the worst part of the winter in the absence of icebreaker assistance. The new ships are equipped with a single tractor-type 16 MW Azipod propulsion unit and have the highest Finnish-Swedish ice class, 1A Super. They are designed to be capable of independent navigation and icebreaking in Baltic ice conditions with a possibility to operate also in the Pechora Sea, in the Russian Arctic. The ships follow the double acting principle with a bulbous bow for open water performance and a stern designed for icebreaking performance as shown in Figure 6-26. These ships can break level ice up to 1 meter thick at 3 knots when operating in the astern mode.<sup>74</sup>

**SS Manhattan—Northwest Passage.** The oil tanker *SS Manhattan* (Figure 6-27) was built in 1962 in Quincy, Massachusetts, and became the first commercial ship to cross the Northwest Passage in 1969. Extensive research and design went into developing a conversion suitable for Arctic transits. She was fitted with an icebreaker bow and other reinforcements in 1968-69.

*Manhattan's* first Arctic voyage began in August 1969 on the East Coast of North America and transited the passage from east to west and then returned to the U.S. East Coast.<sup>75</sup> The following year, 1970, the *Manhattan* again went into the Arctic on an experimental voyage; however, the decision to build the Trans-Alaska Pipeline was made and oil is now

tankered from southern Alaska to U.S. ports in the Lower 48.

**Bent Horn Oil Export.** In 1985, Panarctic Oil Company became a commercial oil producer in the Arctic on an experimental scale, exporting oil during the summer season from the Cameron Island field in the Canadian Archipelago. This began with a single 100,000-barrel tanker load of oil from the Bent Horn oil field to Montreal via the double hulled OBO MV *Arctic* (Figure 6-28). The MV *Arctic* carried two shipments per year until Bent Horn operations ceased in 1996.

### Current State of the Technology

There are several recent major projects and installations that characterize the current state of technology both in tankering in ice and for tanker offtake in ice. The projects are described below.

**Sakhalin-1 Project Tanker Offtake.** Sakhalin-1's oil transportation system was commissioned in August 2006. Construction was completed on a 226 kilometer (140 mile) pipeline to transport crude oil from the onshore processing facility across Sakhalin Island and the Tatar Strait to the De-Kastri Terminal in Russia's Khabarovsk Krai. Tanker loading operations (shown in Figure 6-29) began at De-Kastri in September 2006.

The De-Kastri Terminal includes two 100,000-cubic meters (650,000 barrel) capacity storage tanks



Photo: Aker Arctic.

**Figure 6-26.** *MV Tempera – Double Acting Icebreaking Tanker*



Photo: ExxonMobil.

**Figure 6-27.** *SS Manhattan – Icebreaking Tanker*



Photo: Fednav Limited.

**Figure 6-28.** *MV Arctic*



Photo: Sakhalin-1 Project.

**Figure 6-29.** *Tanker Loading at De-Kastri Single Point Mooring Platform*

to hold the Sakhalin-1 crude oil. From storage, the crude oil is transported via a subsea loading line to the single point mooring facility, located 5.7 kilometers east of the Klykov Peninsula in Chikhacheva Bay.

A dedicated fleet of double-hulled Aframax-class tankers each carrying up to 100,000 tons (720,000 barrels) is used for export of crude oil from the De-Kastri Terminal to world markets. Sakhalin-1 was the first project to successfully operate tankers year-round in the sub-Arctic conditions of Russia's Far East.

In November 2009, the De-Kastri Terminal was named Terminal of the Year 2009 at the Oil Terminal Conference in St. Petersburg. This prestigious award was voted on by top industry experts and government officials and granted to the international terminal achieving the best results in terms of the efficiency of its operations in such areas as economics, environmental, and social. As of July 2011, the Sakhalin-1 Consortium had uploaded over 400 tankers from the De-Kastri Terminal without a single offshore spill incident.

**Varandey Offshore Loading and Tanker Offtake—Pechora Sea.** The Varandey terminal (Figure 6-30) was placed in service in 2008 and in the first 5 years of operation, 26.37 million tons of oil were shipped by 381 ice-class tanker-loads through the fixed offshore ice-resistant oil terminal (FOIROT), a steel conical structure equipped with a loading boom for bow loading of tankers. The FOIROT is located approximately

15 miles offshore and is in about 17 meters of water. The terminal is serviced by three specially designed icebreaking tankers of 70,000 DWT, built by Samsung in Korea. These ships operate year-round and are supported, at the terminal only, by two ice-management vessels, built in Singapore by Keppel. The Varandey oil terminal serves as a venue for annual maneuvers dedicated to emergency oil spill response. No actual emergency situations were registered during the above 5-year period.<sup>76</sup>

**Norilsk-Nickel Tanker.** Norilsk-Nickel, one of the leading nickel mining companies, has built a number



Photo: MacGregor Pusnes AS.

**Figure 6-30.** *Tanker Loading at Varandey Terminal*

of ships for year-round navigation to Dudinka on the Taimyr Peninsula in Siberia. The initial ships in the fleet were cargo ships, but recently the company built a tanker to provide year-round service to its facilities. The tanker *Yenisei*, built in Germany, is capable of breaking ice up to 1.5 m thick and is capable of operating in temperatures as low as -50 degrees Celsius.

**Direct Offtake Loading to Tanker—Prirazlomnaya Platform.** The field development for the Prirazlomnaya project is based on the single stationary fixed platform. The oil platform, constructed by Sevmash shipyard in Severodvinsk, and entered service in the spring of 2013. Produced oil is directly loaded onto tankers using arms at the opposite corners of the platform (Figure 6-31) and is transported by two icebreaking tankers built in Admiralty Shipyard, St. Petersburg, and operated by Sovcomflot, to floating storage and offloading vessel *Belokamenka*, located in Kola Bay near Murmansk.

**Yamal Arctic LNG Carrier on Order.** The double acting ship concept has also been selected as the main transportation concept for the Yamal LNG project. In July 2013, Daewoo Shipbuilding & Marine Engineering won the tender for the construction of sixteen Arc7 ice-class LNG carriers and the contract for the first vessel, worth 339.3 billion South Korean won

(\$316.4 million), was signed in March 2014. The Arctic LNG carriers are fitted with three 15 MW ABB Azipod propulsion units, and will be the largest icebreaking vessels in the world with an independent ice-going capability in level ice up to 2.1 m in thickness.

**International Regulations, Polar Code, and IACS Polar Class.** During the past decade considerable international effort has resulted in the creation a set of unified requirements for the construction of Polar Class ships. These are now contained in the rules of members of the International Association of Classification Societies, resulting in a harmonized set of design and construction requirements know as Polar Class with ice classes PC1 through PC7 reflecting ship operational capability in ice conditions varying from PC1 in year-round operation in all polar waters to PC7 in summer/autumn operation in thin first-year ice which may include old ice inclusions.<sup>77</sup>

Further, the multi-year effort at the International Maritime Organization (IMO) to create a Polar Code (formally the “International Code for Ships Operating in Polar Waters”) is being finalized and is anticipated to come into force in 2017. The safety provisions in the Polar Code are incorporated into the IMO Safety of Life at Sea (SOLAS) regulations as the new Chapter 14 (approved at MSC93 in May 2014). The



Photo: Gazprom.

**Figure 6-31.** Direct Offtake Loading to Tanker – Prirazlomnaya Platform Pechora Sea

pollution prevention measure in the Polar Code are incorporated into IMO Marine Pollution (MARPOL) regulations as amendments to Annexes I, II, V and VI (anticipated to be approved at MEPC67 in October 2014). It is noted that the IACS Polar Class rules are included in the Polar Code by reference.<sup>78</sup>

All ships that are certificated under SOLAS and operating in polar waters will be required to comply with the Polar Code. Ships of 500 gross tonnage, engaged on international voyages are, in general, required to be in compliance with SOLAS and are certificated as such.

### **Prudent Development Context**

Direct offtake of oil from an offshore platform and transport by tankers involves several dimensions of prudent development. Since crude oil is being transferred, high integrity operations are required to protect against spills. While large spill volumes are very unlikely due to the ability to rapidly shut off flow, transfer activities take place on a frequent basis, which presents more opportunity for incidental spills that must be managed. Of course, tanker operations must be carefully managed to prevent grounding or holing from impact with ice that exceeds design and operational allowances.

Direct offloading from platforms would involve ice management whose potential impacts on ice-dependent species needs to be understood and minimized, as discussed previously in the section on ice management. Likewise, year-round tanker traffic through ice could have impacts on ice-dependent species that need to be understood and minimized.

The cost of year-round tanker operations in ice can be very high due to the additional capital and operating costs of icebreaking tankers, and especially if escort icebreakers are required to facilitate on-schedule transit in heavy winter ice. There are export option trade-offs between direct offloading to tankers from an offshore platform and pipelines to shore that will differ for every field depending on the location and ice conditions. The choice of tanker or pipeline for crude oil evacuation may be linked to the presence or lack of existing pipeline infrastructure. Depending on tax and revenue structures, the choice between offshore offtake and pipeline to shore may impact revenue to local communities.

### **Recent and Ongoing Research Activities**

Considerable effort has been expended over the past three or more decades on R&D associated with ice transiting ships. The majority of the vessels referenced above have been used through dedicated trials and ongoing operational studies to gain further knowledge of ship-ice hull structure interaction, propulsion system-ice performance, safe navigation practices, etc.

Laboratories and research institutes such as Aker Arctic and VTT, Finland; HSVA, Germany; Krylov Institute, Russia; National Research Council and Memorial University, Canada; and others have all contributed to this knowledge base. Much of the research on the basics that allow for safe operations of ice transiting ships has already been done in support of effort such as the IACS Polar Rules and the IMO Polar Code, but some recent research aimed at developing design and analysis tools has been ongoing, as well as work to look at improving the efficiency of ships navigating in ice.

For example, the STePS2 project is a recently completed 5-year investigation into ice loads and structural response, conducted at the Memorial University of Newfoundland. The aim was to develop scenario-based design and analysis tools that would enable progressively improving safety, durability, economic viability, and technical confidence. The STePS2 project has examined range of load and strength behaviors by combining small and large-scale physical tests with high-performance and high-fidelity numerical simulations.<sup>79</sup>

### **Technology/Capability Enhancement Opportunities**

***Research and Training Simulators for Arctic Navigation.*** Technical developments of ships and off-take structures are well advanced, and opportunities for improvement lie mainly in training and operational experience development and in enhancement of aids to navigation and charting of Arctic waters. As Arctic navigation expands, there is a need for more trained operational personnel. Within the IMO Polar Code there are specific requirements for the competence and experience of deck officers on ships in polar waters. This requirement combined

with the need to establish operating envelopes as part of the front end design process suggest that the design, construction, and operation of ice navigation simulators might be desirable. Such simulators could be used during the design process to test out various design features and to research operational techniques such as active ice-management around a drilling unit. In addition these facilities could be used for direct training of deck officers who will be responsible for safe and efficient navigation of their ships in ice-prone waters.

***Aids to Navigation.*** The Arctic is an area of the world where aids to navigation and bathymetric charting are less available, or less accurate, than in southern waters. Enhancement of these systems is a governmental responsibility; however, the industry may have more assets available, so some level of cooperation should be of benefit to all parties.

## **CONCLUSIONS AND RECOMMENDATIONS**

The technologies to accomplish prudent offshore exploration and development for the U.S. waters within this study scope (i.e., Alaskan state waters and the Alaskan OCS out to water depths amenable to development using conventional bottom-founded structures) already exist as a result of decades of practice and experience; and industry is continuing to improve its technology. Overall, prudent development depends on the ability to select an appropriate combination of technologies for both safety and cost efficiency. There will always be opportunity for technology enhancement, as the industry continuously strives for better safety, environmental protection, and cost effectiveness, or to extend safe operations into more challenging ice environments. Many such advancement opportunities have been cited in the preceding sections that discuss the various technology components for offshore Arctic E&D. While these incremental improvements, taken collectively over time, will improve performance, no single one of the technology improvements could be expected to make a material difference in the ability to prudently explore and develop the U.S. Arctic offshore.

Exploration drilling is the important first step for progressing toward prudent development of oil and gas offshore Alaska because commercially viable oil accumulations are needed to justify development. Better demonstration of the link between technology

capability, operating season, and operating framework is needed to improve cost effectiveness and risk management for exploration drilling. The highest priority E&D technologies are those needed to extend and enhance extended season drilling operations (in ice) that meet the strict operational reliability requirements of hydrocarbon drilling while simultaneously not creating unacceptable impacts on ice-dependent species or subsistence hunting. At the core of such capability is ice management, which comprises a variety of component technologies that collectively support station-keeping in mobile pack ice. The priority is deemed high due to the critical economic importance of extending the useful season for exploration drilling. Extension of the drilling season must also be supported by robust emergency response capabilities (oil spill response and well capping) that are discussed in Chapter 8 of this study.

The most significant opportunity under extended season drilling is to perform research studies and tests that directly inform key policy or regulatory issues regarding usable season length. Such studies should be conducted as collaborative efforts involving industry, government, and key stakeholders. Aligned with this objective are studies to determine the interaction of extended season ice management activities in specific locations with ice-dependent species and the potential impacts on local inhabitants' use of the ice for traditional and subsistence activities.

Beyond studies to understand impacts of ice management on ice-dependent species, field trials of integrated ice management activities could be used to demonstrate the extent or severity of ice conditions under which reliable ice management can be conducted with the current state of technology (beyond limits already proven by past programs). Such demonstrations could include how ice management operations can be used to facilitate other key technologies like installation of well control equipment in ice-covered water.

As exploration drilling efforts prove up commercial accumulations of oil in the U.S. Arctic offshore, focus will naturally turn to making significant advancements of the technologies needed for the development phase. In addition to the types of technology improvements discussed above, this will require collection of additional data characterizing the ice environment to facilitate the safest and most cost effective designs for platforms, vessels, and pipelines.

## REFERENCES

- 1 Macdougall, J. Richard, Verhoef, Jacob, Sanford, Wendell, and Marcussen, Christian (2008), "Challenges of Collecting Data for Article 76 in Ice Covered Waters of the Arctic," in 5th IHO-IAG ABLOS Conference, International Hydrographic Bureau, Monaco, 15-17 October 2008.
- 2 U.S. Geological Survey (2004), *Seismic reflection and refraction data acquired in Canada Basin, Northwind Ridge and Northwind Basin, Arctic Ocean in 1988, 1992 and 1993*, U.S. Geological Survey Western Region Coastal and Marine Geology. ([http://pubs.usgs.gov/of/2004/1243/data\\_acquisition.html](http://pubs.usgs.gov/of/2004/1243/data_acquisition.html)).
- 3 Barentsen, K. (2011), "2010 Statoil Seismic Survey," presented at National Oceanic and Atmospheric Administration Arctic Open Water Meeting, Anchorage, Alaska, March 7, 2011.
- 4 Rice, S, Dudley, T, Schneider, C, Pierce, R, Horn, Cameron, BS, Bloor, R, and Zhou, Z (2013), "Arctic seismic acquisition and processing," *The Leading Edge*, May 2013.
- 5 Funk, DW, Ireland, DS, Rodrigues, R, and Koski, WR (eds.) (2010), *Joint Monitoring Program in the Chukchi and Beaufort seas, open water seasons, 2006-2008*, LGL Alaska Report P1050-2, Report from LGL Alaska Research Associates, Inc., LGL Ltd., Greeneridge Sciences, Inc., and JASCO Research, Ltd., for Shell Offshore, Inc. and Other Industry Contributors, and National Marine Fisheries Service, U.S. Fish and Wildlife Service. p. 506 plus appendices.
- 6 IMV Projects Atlantic Inc. (2008), *Arctic Offshore Technology Assessment of Exploration and Production Options for Cold Regions of the US Outer Continental Shelf*, prepared for the U.S. Department of the Interior, Minerals Management Service, IMV Project No. C-0506-15, January 31, 2008.
- 7 ISO 19906 "Petroleum and natural gas industries – Arctic offshore structures," 2010.
- 8 Noble, PG, Shafer, RS, Berta DP, Chow, YY, Cheung, TO, Foo, KS, Quah, CK, and Cynthia Wang, C (2013), "Dual-derrick ice-worthy jack-up drilling unit," U.S. Patent Publication US 20130101357 A1, Application Number US 13/396,457, April 25, 2013.
- 9 Timco, GW, and Frederking, R (2009), *Overview of Historical Canadian Beaufort Sea Information*, NRC Canadian Hydraulics Centre, Technical Report CHC-TR-057.
- 10 Hnatiuk, J and Wright, BW (1984), "Ice Management to Support the Kulluk Drilling Vessel," 35th Annual Technical Meeting of the Petroleum Society of CIM Held Jointly with the Canadian Association of Drilling Engineers, Calgary, June 10-13, 1984.
- 11 Gaida, KD, Barnes, JR, and Wright, BW (1983), "Kulluk – An Arctic Exploratory Drilling Unit," OTC 4481, OTC, Houston, Texas, May 2-5, 1983.
- 12 Keinonen A, Wells H, Dunderdale P, Pilkington R, Miller G, Brovin A (2000), "Dynamic Positioning Operation in Ice Offshore Sakhalin, May-June 1999," Proceeding of the Tenth International Offshore and Polar Engineering Conference, Seattle USA, May 28-June 2, p. 683-690.
- 13 Tiffin, S, Pilkington, R, Hill, C, Debicki, M, McGonigal, D, and Jolles, W (2014), "A Decision Support System for Ice/Berth Surveillance, Advisory and Management Activities in Offshore Petroleum Operations," Proceedings of the OTC Arctic Technology Conference, Houston, TX, Paper No OTC 24657.
- 14 Petroleum Research Newfoundland & Labrador (2014), "Joint Industry Program: Development of Improved Ice Management Capabilities for Operations in Arctic and Harsh Environments," November 2014, [www.petroleumresearch.ca](http://www.petroleumresearch.ca).
- 15 Hamilton J, Holub C, Blunt J, Mitchell D, and Kokkinis T (2011), "Ice Management for Support of Arctic Floating Operations," Proceedings OTC Arctic Technology Conference, Feb. 7-9, Houston, Texas.
- 16 Løset, S, Kanestrøm, Ø, and Pytte, T (1998), "Model Tests of a Submerged Turret Loading Concept in Level Ice, Broken Ice and Pressure Ridges," *Cold Regions Science and Technology*, 27(1), 57-73.
- 17 Kokkinis, T, Brinkmann, CR, Ding, J, and Fenz, DM (2010), "Arctic Deepwater Development Drilling Design Considerations," Paper Ice-tech10-115-RF, Proceedings, Ictech 2010 Conference, Anchorage, Alaska, 2010.
- 18 Eik, K and Gudmestad, OT (2010), "Iceberg management and impact on design of offshore structures," *Cold Regions Science and Technology* 63 (2010) 15–28.
- 19 Maddock B, Bush A, Wojahn T, Kokkinis T, Younan A, and Hawkins J (2011), "Advances in Ice Management for Deepwater Drilling in the Beaufort Sea," Proceedings Ports and Ocean Engineering under Arctic Conditions Conference, July 10-14, Montreal, Canada.
- 20 Scibilia F, Metrikin I, Gurtner A, and Henrik S (2014), "Full-Scale Trials and Numerical Modeling of Sea Ice Management in the Greenland Sea," Proceedings Arctic Technology Conference, February 10-12, Houston, TX, OTC 24643.
- 21 Keinonen A, Shirley M, Liljestrom G, and Pilkington R (2006), "Transit and Stationary Coring Operations in the Central Polar Pack," Proceedings Ictech '06 Conference, Society of Naval Architects and Marine Engineers, July 16-19, 2006, Banff, Canada.
- 22 Garas, V, Simms, A, Lennox, T, Jonasson, B, Blunt, J, and Kokkinis, T (2014), "Aerial Reconnaissance in Support of Arctic Drilling Operations: Requirements, Challenges and Potential Solutions," Proceedings of the Arctic Technology Conference, Houston, TX.
- 23 Blunt, JD, Mitchell, DA, Matskevitch, DG, Younan, AH, and Hamilton, JM (2012), "Tactical Sea Ice Drift Forecasting for Summer Operation Support in the Canadian Beaufort Sea," 2012 Arctic Technology Conference, Houston, TX, 3-5 December.
- 24 ISO 19906, "Petroleum and natural gas industries – Arctic offshore structures," 2010.
- 25 DNV (2012), *Barents 2020: Assessment of international standards for safe exploration, production and transportation of oil and gas in the Barents Sea*, Final Report Phase 4, Report No. 2012-0690.
- 26 ISO 19906, "Petroleum and natural gas industries – Arctic offshore structures," 2010.
- 27 Barker, Anne, Timco, Garry, and Wright, Brian (2006), "Traversing Grounded Rubble Fields by Foot – Implications for Evacuation," *Cold Regions Science and Technology*, V. 46, pp. 79-99.
- 28 Bercha, FG (2010), "Arctic EER Today," Proceedings, International Conference and Exhibition on Performance of Ships and Structures in Ice, ICETECH-10, Anchorage, Alaska, USA, 2010.
- 29 Polomoshnov, A (1998), "Scenario of Personnel Evacuation from Platform on Sakhalin Offshore in Winter Season," Proceedings of the International Conference on Marine Disasters: Forecast and Reduction, pp 351-355, Beijing, China, 1998.
- 30 Spencer, Paul, Graham, Bill, Barker, Anne, Timco, Garry, and Wright, Brian (2007), "Construction Aspects of Building an Evacuation Route Through Rubble Surrounding Beaufort Sea Structures," Proceedings 19th International Conference on Port and Ocean Engineering Under Arctic Conditions, POAC'07, June 27-30, 2007, Dalian, China, pp. 823-832.
- 31 Poplin, J.P., Wang, A.T., and St. Lawrence, W. (1998), "Considerations for the Escape, Evacuation and Rescue from Offshore Platforms in

- Ice-Covered Waters,” Proceedings of the International Conference on Marine Disasters: Forecast and Reduction, pp 329-337, Beijing, China.
- 32 Timco, G.W. and Dickins, D.F. (2005), “Environment Guidelines for EER Systems in Ice-Covered Waters,” *Cold Regions Science and Technology* 42, pp 201-214.
  - 33 Wright, B., Timco, G., Dunderdale, P., and Smith, M. (2002), “Evaluation of Emergency Evacuation Systems in Ice Covered Waters,” B. Wright & Assoc. report submitted to NRC-CHC (PERD/CHC Report 11-39), Canmore, Canada.
  - 34 Wright, B. (2010), “Key Considerations related to the Use of Support Vessels for Personnel Evacuation from Offshore Structures in the Canadian Beaufort Sea,” B. Wright & Assoc. report submitted to NRC-CHC, Canmore, Canada.
  - 35 Poplin, J.P. and Timco, G.W. (2003), “Ice Damage Zone around Conical Structures: Implications for Evacuation,” Proceedings 17th International Conference on Port and Ocean Engineering under Arctic Conditions, POAC’03, Vol. 2, pp 797-806, Trondheim, Norway.
  - 36 Timco, G.W., Wright, B.D., Barker, A., and Poplin, J.P. (2006), “Ice Damage Zone around the Molikpaq: Implications for Evacuation Systems,” *Cold Regions Science and Technology* 44, pp 67-85.
  - 37 Bercha, F.G. (2010), “Arctic EER Today,” Proceedings, International Conference and Exhibition on Performance of Ships and Structures in Ice, ICETECH-10, Anchorage, Alaska, USA.
  - 38 Poplin, J.P. and Timco, G.W. (2003), “Ice Damage Zone around Conical Structures: Implications for Evacuation,” Proceedings 17th International Conference on Port and Ocean Engineering under Arctic Conditions, POAC’03, Vol. 2, pp 797-806, Trondheim, Norway.
  - 39 Timco, G.W., Wright, B.D., Barker, A., and Poplin, J.P. (2006), “Ice Damage Zone around the Molikpaq: Implications for Evacuation Systems,” *Cold Regions Science and Technology* 44, pp 67-85.
  - 40 Royal Commission on the Ocean Ranger Marine Disaster (1984), Safety Management Seminar Proceedings, Royal Commission on the Ocean Ranger Marine Disaster, St. John’s, Canada.
  - 41 Cullen, W. D. (1990), *The Public Inquiry into the Piper Alpha Disaster*, UK Department of Energy, 488 p.
  - 42 Petrobras 36 Inquiry Commission Final Report, June 2001.
  - 43 National Commission on the BP Deepwater Horizon Oil Spill and Offshore Drilling, Report to the President, “Deep Water: The Gulf Oil Disaster and the Future of Offshore Drilling,” January 2011.
  - 44 Bercha, F.G. (2010), “Arctic EER Today,” Proceedings, International Conference and Exhibition on Performance of Ships and Structures in Ice, ICETECH-10, Anchorage, Alaska, USA.
  - 45 Poplin, J.P. and Bercha, F.G. (2010), Arctic Offshore Escape, Evacuation, and Rescue Standards and Guidelines. Proceedings ICETECH 2010. Paper No. ICETECH10-108-RF. Anchorage, USA.
  - 46 Spencer, Paul, Graham, Bill, Barker, Anne, Timco, Garry, and Wright, Brian (2007), “Construction Aspects of Building an Evacuation Route Through Rubble Surrounding Beaufort Sea Structures,” Proceedings 19th International Conference on Port and Ocean Engineering Under Arctic Conditions, POAC’07, June 27-30, 2007 Dalian, China, pp 823-832.
  - 47 Barker, A., G. Timco, A. Simões Ré, and B. Wright (August 2013), “Seasonal Strategies for Evacuation From Offshore Structures in the Beaufort Sea,” In *Oil Gas and Mining*, Vol. 1, Issue 1 (<https://www.oilgasandmining.com/volume1/issue1/83-v1n1-barker>).
  - 48 Barker, A., Timco, G, Wright, B., and McDermott, S. (2009), “Decision Process for Emergency Evacuation Shelters in the Beaufort Sea,” Proceedings of the 20th International Conference on Port and Ocean Engineering under Arctic Conditions, June 9-12, 2009, Lulea, Sweden.
  - 49 Barker, Anne, Wright, Brian, and Timco, Garry (2007), “Assessment of the Viability of On-Ice Evacuation Shelters in the Beaufort Sea,” Proceedings of the 20th International Conference on Port and Ocean Engineering under Arctic Conditions, June 27-30, 2007, Dalian, China.
  - 50 Barker, Anne, Timco, Garry, and Wright, Brian (2006), “Traversing Grounded Rubble Fields by Foot – Implications for Evacuation,” *Cold Regions Science and Technology*, V. 46, pp. 79-99.
  - 51 Barker, A., Timco, G.W., Wright, B., and McDermott, S., “Assessment of the Viability of On-Ice Evacuation Shelters in the Beaufort Sea,” PERD/CHC Report 29-9, CHC Report CHC-TR-037.
  - 52 Seligman, B. and Bercha, F. (2012), “ARKTOS New Developments,” ICETECH 2012, Banff AB.
  - 53 Poplin, J.P., Wang, A.T., and St. Lawrence, W. (1998), “Escape, Evacuation and Rescue Systems for Offshore Installations in Ice-Covered Waters,” Proceedings of the International Conference on Marine Disasters: Forecast and Reduction, pp 338-350, Beijing, China.
  - 54 Wright, B.D., Timco, G.W., Dunderdale, P., and Smith, M. (2003), “An Overview of Evacuation Systems for Structures in Ice-Covered Waters,” Proceedings 17th International Conference on Port and Ocean Engineering under Arctic Conditions, POAC’03, Vol. 2, pp 765-774, Trondheim, Norway.
  - 55 Timco, G.W. and Dickins, D.F. (2005), “Environment Guidelines for EER Systems in Ice-Covered Waters,” *Cold Regions Science and Technology* 42, pp 201-214.
  - 56 Poplin, J. P and Bercha, F.G. (2010), “Arctic Offshore Escape, Evacuation, and Rescue Standards and Guidelines,” Proceedings ICETECH 2010, Paper No. ICETECH10-108-RF, Anchorage, USA.
  - 57 Wright, B., Browne, R., Timco, G., and Barker, A. (2011), “Key Considerations Related to the Use of Support Vessels for Personnel Evacuation from Offshore Structures in the Beaufort Sea,” Proceedings of the 21st International Conference on Port and Ocean Engineering under Arctic Conditions, July 10-14, 2011, Montréal, Canada.
  - 58 Poplin, J., Bercha, F, Brummelkamp, C., Dickins, D., Knight, S., Mansurov, M., Mørland, M., Onshuus, D., Santos-Pedro, V., Simões Re, A., and Timco, G. (2011), ISO 19906 – Implications for Arctic Offshore Escape, Evacuation and Rescue, Proceedings of the 21st International Conference on Port and Ocean Engineering under Arctic Conditions, July 10-14, 2011, Montréal, Canada.
  - 59 Bercha, F.G. and Gudmestad, O.T. (2008), Reliability of Arctic Offshore Structures, Proceedings ICETECH-08, Banff, Canada.
  - 60 Cullen, W.D. (1990), *The Public Inquiry into the Piper Alpha Disaster*, UK Department of Energy, 488 p.
  - 61 Royal Commission on the Ocean Ranger Marine Disaster (1984), Safety Management Seminar Proceedings, Royal Commission on the Ocean Ranger Marine Disaster, St. John’s, Canada.
  - 62 Barker, A., G. Timco, A. Simões Ré, and B. Wright (August 2013), “Seasonal Strategies for Evacuation From Offshore Structures in the Beaufort Sea,” In *Oil Gas and Mining*, Vol. 1, Issue 1 (<https://www.oilgasandmining.com/volume1/issue1/83-v1n1-barker>).
  - 63 Palmer, AC (2000), “Are we ready to construct submarine pipelines in the Arctic?” Proceedings, 32nd Annual Offshore Technology Conference, OTC 2000, Houston, TX, USA, 3, Paper OTC12183, 737-744, May 2000.
  - 64 Weeks WF (2010), *On Sea Ice*, University of Alaska Press, 664 p.

- 65 Blasco, S, Bennett, R, Brent, T, Burton, M, Campbell, P, Carr, E, Covill, R, Dallimore, S, Davies, E, Hughes-Clarke, J, Issler, D, Leonard, L, MacKillop, K, Mazzotti, S, Patton, E, Rogers, G, Shearer, J, and White, M (2013), "2010 State of Knowledge: Beaufort Sea Seabed Geohazards Associated with Offshore Hydrocarbon Development," Geological Survey of Canada, Open File 6989, 340 p. doi:10.4095/292616, Oct 2013.
- 66 Palmer, AC and Croasdale, KR (2013), *Arctic Offshore Engineering*, World Scientific Publishing Co. Pte. Ltd., Singapore.
- 67 Hamilton, JM and Jones, JE (2009), "Sakhalin-1: Technology Development for Frontier Arctic Projects," Proceedings Offshore Technology Conference, OTC-20208-MS, Houston, TX, May 4-7, 2009.
- 68 DNV (2008), *State of the Art Review: Arctic Specific Hazards to the Design of Arctic Offshore Pipelines*, Energy Report ICE PIPE JIP, Report no/DNV Reg. No.: 2008-1267/ 121CU6F-54, Rev 02, 2008-08-26.
- 69 C-CORE (2008), *Design Options for Offshore Pipelines in the US Beaufort and Chukchi Seas*, prepared for US Department of the Interior, Minerals Management Service, C-CORE Report R-07-078-519v2.0, April 2008.
- 70 Randell, C, Morgan, V, and Ralph, F (2008), "Protection and Risk Mitigation Strategies of Subsea Infrastructure in Ice Environments," Proceedings Offshore Technology Conference, OTC 19272, Houston, TX, May 2008.
- 71 Thodi, P, Paulin, M, DeGeer, D, and Lanan, G (2012), "Offshore Pipeline Leak Detection Technologies for Arctic Applications," Subsea and Arctic Leak Detection Symposium 2012.
- 72 Randell, C, Morgan, V, and Ralph, F (2008), "Protection and Risk Mitigation Strategies of Subsea Infrastructure in Ice Environments," Proceedings Offshore Technology Conference, OTC 19272, Houston, TX, May 2008.
- 73 Fuson, T.J. (1970), "S.S. Manhattan's Northwest Passage Voyages," 2826-MS SPE Conference Paper 1970.
- 74 ABB (2004), "Fortum's Double Acting Tankers," ABB Technical Brochure, [http://www05.abb.com/global/scot/scot293.nsf/veritydisplay/85132e39bb90c45ac1257b1a005b7845/\\$file/Tempera.pdf](http://www05.abb.com/global/scot/scot293.nsf/veritydisplay/85132e39bb90c45ac1257b1a005b7845/$file/Tempera.pdf).
- 75 Mookhoek, A.D. and Bielstein (1971), "Problems Associated with the Design of an Arctic Marine Transportation System," 1426-MS OTC Conference Paper, May 1971.
- 76 Iyerusalimsky, A et al., (2007), "Arctic Crude Oil Transportation System Development," I-07-267 ISOPE Conference Paper, 2007.
- 77 International Association of Classification Societies (2011), "Requirements concerning Polar Class, IACS Req. 2011," [http://www.iacs.org.uk/document/public/Publications/Unified\\_requirements/PDF/UR\\_I\\_pdf410.pdf](http://www.iacs.org.uk/document/public/Publications/Unified_requirements/PDF/UR_I_pdf410.pdf).
- 78 International Maritime Organization (2014), "International Maritime Organization Polar Code Status November 2014," <http://www.imo.org/MediaCentre/HotTopics/polar/Pages/default.aspx>.
- 79 Daley, C (2014), "STePS2 – Sustainable Ship Structures Research, Ship Structures Committee Symposium 2014: ICE."



# Chapter 7

## Logistics and Infrastructure

### CHAPTER SUMMARY

**L**ogistics and infrastructure are critical components of exploration and development. Logistical requirements for exploration include movement of people, drilling and support equipment, and supplies to and from the offshore drilling locations. Infrastructure requirements for exploration include ports, airfields, power supply, and communication networks. Logistical requirements for development include transport and construction of platforms, production facilities, and pipelines during the installation phase; ongoing movement of people and supplies during the production phase; and removal of platforms, production facilities, and pipelines during the eventual decommissioning phase. Development places increasing demand on infrastructure requirements due to the increased activity. These logistical

requirements are typically met through chartering or building of aircraft and maritime assets for specific activities. Alternatively, the infrastructure requirements are ideally met through access to shared resources, recognizing that infrastructure has dual use and benefit to non-oil and gas users, including local communities, military, shipping, commercial tourism, and fishing.

Alaska, by virtue of its location, size, physical environment, and sparse population centers, presents significant challenges to logistics and infrastructure for all users:

- Large area: Alaska is one fifth the size of all the Lower 48 states in the United States. Key locations relevant to Chapter 7 are shown in Figure 7-1.
- Remoteness from the U.S. Lower 48: Alaska is bordered by Canada, which separates it from the

### Pan-Arctic Logistics and Infrastructure Perspective

Most offshore areas of the Arctic have sparse infrastructure and are logistically challenged due to their remoteness and the presence of ice during a majority of the year. There is a general lack of population centers, ports, and airfields to support offshore Arctic exploration and development activities. Existing fabrication yards for construction of offshore structures are thousands of miles from most offshore Arctic opportunity areas. In terms of export, there are two maritime entry/exit routes through the Bering Strait and Barents Sea. The routes to access these maritime entry points from points in between (i.e., through the Northwest Passage across Canada and the United States, and the Northern Sea Route across Russia) are challenged

by heavy ice in the winter and variable ice conditions in the summer. Icebreaking vessels are an important component of Arctic infrastructure, and most of the world's modern, Arctic-capable icebreakers are concentrated in the Baltic countries and Russia. The existing overland export infrastructure that could be used to transport offshore Arctic oil and gas are limited to the Trans-Alaska Pipeline System across Alaska and a series of large gas pipelines leading south from Russia's Yamal Peninsula area. The communications infrastructure servicing the Arctic region is also challenged because most large communication satellites orbit the equator, which results in atmospheric interference for transmissions to and from Arctic locations.



Source: Shell.

**Figure 7-1.** Key Locations Relevant to Chapter 7

U.S. Lower 48, and by waters that include the North Pacific Ocean, Bering Sea, Beaufort Sea, Chukchi Sea, and Arctic Ocean.

- **Access:** The Bering Sea connects the North Pacific Ocean to the Chukchi Sea and leads to the Northwest Passage past Canada and the Northern Sea Route past Russia.
- **Alaska's northernmost point,** Point Barrow, sits well above the Arctic Circle at 71°23'25" north latitude, 156°28'30" west longitude (the Arctic circle is 66°33'45.6" north of the equator).
- **Maritime Infrastructure:** There are no deepwater ports north of Adak and Unalaska in the Aleutian Islands, and few navigational aids exist from Kotzebue Sound to the Canadian border.<sup>1</sup>
- **Supply Routes:** The distance from Seattle to Dutch Harbor, Alaska, the nearest deepwater port to the area considered in this National Petroleum Council study (the U.S. Arctic offshore, which includes both Alaskan state waters nearshore and federal waters,

also known as the Outer Continental Shelf), is nearly 1,600 nautical miles and the distance from Dutch Harbor to the Chukchi Sea is another nearly 1,000 nautical miles; and again another 400 miles to the Beaufort Sea. Compounding this challenge is the general lack of road or rail access between locations in Alaska and the necessity for all supplies to be transported by either sea or air.

- **Aviation Infrastructure:** The four major public airstrips in northern Alaska that support commercial jet aircraft are in Deadhorse (also known as Prudhoe Bay), Barrow, Kotzebue, and Nome. All other communities in northern Alaska are served by gravel runways.
- **Road Access:** The Dalton Highway, terminating at Deadhorse, Alaska, is the only road connecting Alaska's North Slope (the northern slope of the Brooks Range, stretching along the Arctic Ocean coast from the Chukchi Sea on the west to the Beaufort Sea on east) to southern Alaska and the rest of the North American road network. Road

networks beyond Deadhorse only service oilfields and do not connect to any communities.

These factors, including distance, limited infrastructure, and lack of multimodal access, have implications on shipping cost and time. The physical environment further compounds logistics challenges that include potentially harsh oceanographic and meteorological conditions in the Gulf of Alaska and the presence of seasonal ice and cold temperatures with increasing severity between Dutch Harbor and the study area.<sup>a</sup> These challenges have implications for the type of maritime and aviation equipment that can be used.

Nonetheless, Native activity in the study area has been ongoing for the last 10,000 or more years and Western activity the last two centuries, starting with whaling that began in the early 1800s with coastwise trade and associated commercial activity rapidly following. Oil and gas activity started in the late 1960s with discovery of the Prudhoe Bay field and subsequent sealifts used to transport drilling equipment and large prefabricated facilities from the Gulf of Mexico to Prudhoe Bay. This history, as well as the subsequent offshore drilling activity that has taken place, are summarized in Chapter 1.

Based on this experience and in spite of the challenges and limitations of Alaska's existing infrastructure, current logistics capabilities and infrastructure are deemed sufficient to enable and support safe exploration activities. However, the current infrastructure comes with inefficiencies that add time and cost. Upgrades will be required for future development because of the increased scale of operations associated with production, compared to those associated with exploration, and risk of overloading current infrastructure. (Chapter 2 describes exploration and development concepts in greater detail.) Additional perspective follows:

- While Dutch Harbor is in many respects capable of supporting oil and gas activities, it is located far from the study area and currently serves the fishing industry. Dutch Harbor is not currently set up for servicing the large vessels needed for oil and gas activities.

<sup>a</sup> For the purposes of this NPC Arctic research study, "the study area" refers to the U.S. Arctic offshore, including both Alaskan state waters (nearshore) and federal waters, also known as the Outer Continental Shelf (OCS).

- Current design and operational practices for maritime and aviation assets operating in the Arctic environment provide a suitable framework for safe operation. These include international conventions such as the Polar Code, U.S. Coast Guard and U.S. Federal Aviation Administration (FAA) regulations, international standards, industry guidelines, and individual owner/operator requirements.
- As commercial activity in the Arctic expands, initiatives like the Polar Code will strengthen and standardize current practices across global operating regions.
- The Arctic region imposes technical and commercial constraints on the pool of available maritime vessels:
  - Requirements for safe and reliable operation, including winterization that satisfies vessel ice classification standards, can substantially increase maritime vessels' costs relative to temperate environments like the Gulf of Mexico.
  - The Jones Act has an exaggerated impact on cost due to the very limited U.S. flag maritime vessels that can both meet the Jones Act requirements and have the requisite ice class to work in the study area.
- While fragile permafrost and wetland ecosystems impact land-based logistics and supporting infrastructure, road technology in the Alaskan Arctic is well established and includes both seasonal ice roads and year-round gravel roads.
  - For gravel roads, construction requirements are set by bearing capacity and heat transfer, and key constraints are the availability of and proximity to gravel resources.
  - Social impact limits and constraints are well documented and result from the interdependency of land use of competing interests ranging from subsistence hunting to wildlife protection and critical habitat designation.

Infrastructure upgrades for exploration can increase operational efficiencies and at the same time reduce environmental impacts and provide positive social benefits, which together enable prudent development. Examples of infrastructure upgrades include new ports closer to the study area, new airfields located away from existing communities and

subsistence hunting areas, connecting roads, and higher bandwidth communication networks.

There are many synergies between the types of infrastructure that would facilitate oil and gas exploration and development and the infrastructure needs of local communities, the state of Alaska, and elements of the U.S. Armed Forces, such as the U.S. Coast Guard and U.S. Navy, that have Arctic missions. Investments by any party in new or upgraded airfields, ports, roads, navigational aids, satellites, radars, and high-bandwidth communications facilities could confer wide benefits. The Coast Guard and Navy, which play key roles in the areas of safety, search and rescue and security, and national defense, are subject to many of the same resupply and support requirements in the Arctic as the oil and gas industry. These organizations could also play a complementary role in the sharing of infrastructure.

The principal opportunity for improving logistics is in the optimization of existing transport solutions. There are also opportunities in alternatives to conventional modes of transport that offer different approaches and may have different environmental impacts, but these are generally not without limitations. These alternatives include hovercraft, airships (lighter than air), and new icebreaker designs. In most cases, these technologies exist today; however, some level of adaptation or demonstration is required for the Arctic or the scale of the operation. Further maturation of these technologies is probably best done by the technology provider on a speculative basis or in conjunction with an operator's specific plans.

Summing up, key opportunities for enhancement in logistics and infrastructure are in the form of equipment and infrastructure investment opportunities and not in the development of new technology per se. Individual companies can be expected to invest as needed to support their plans, but incremental investment might bring substantial additional societal benefit. Ideally, where infrastructure investment will benefit both public (federal, state, and local) and private sectors, decisions should be made jointly and costs appropriately shared. A likely challenge will be alignment of timelines, with individual companies needing to make investment decisions that may run ahead of public needs. At a minimum, private and public entities should collaborate

to ensure informed decision-making. Early engagement with the Native population in infrastructure and activity planning is key to maximizing the total societal benefit of investment.

Careful study of new infrastructure is required to ensure that the desired functionality will be achieved, the risks have been identified, and that possible unintended consequences have been assessed. Trade-offs will invariably exist. For example, a new port would ideally be located close to the study area in an ice-free location and be accessible by road, but it may not be possible to satisfy all of these requirements at a particular location.

The high-level logistics and infrastructure recommendations from this study are as follows:

- Local, state, and federal government agencies should coordinate infrastructure planning by carrying out, where possible, joint scenario planning to identify the intersection of mutual needs, such as airfields, ports, roads, communications, to identify opportunities for investment synergies. Planning needs and considerations should include those from oil and gas industry, U.S. Navy, U.S. Coast Guard, and local stakeholders. Planning needs from the Trans-Alaska Pipeline System for life extension should also be included.
- As an example, government, with relevant stakeholders, should consider review of the recommendations from Deep-Draft Arctic Port System Study final report with a specific focus on oil and gas infrastructure needs. The final report is due mid-2015.
- Recognizing the potential for increasing needs in the Arctic from all industries, the U.S. Coast Guard icebreaker fleet and presence should be expanded and extended into the shoulder season to promote transportation safety, national security, and a longer exploration season.
- The U.S. and Canadian federal governments should continue their long history of cross-border incident management and response. Consideration should also be given to enhancing cross-maritime border coordination for incident response between the U.S. and Russian Coast Guards.
- Government should consider carrying out a study of gravel resources and usage implications across the North Slope.

- Recognizing the potential for increased vessel traffic in Bering Strait in the future, actions should be taken now to improve vessel safety:
  - The United States should support implementation of the International Maritime Organization Polar Code to ensure that maritime vessels transiting the Bering Strait and operating in U.S. Arctic waters meet the requirements of the Polar Code, including design, construction, equipment, operations, training, search and rescue, and environmental protection.
  - The National Oceanic and Atmospheric Administration (NOAA) should complete hydrographic mapping of the region to improve nautical charts.
  - The U.S. Coast Guard should improve regional navigational and communication aids and continue development of comprehensive Arctic maritime traffic awareness systems.
- Opportunities for policy/regulatory enhancements should be explored, including reducing restrictions on wetlands use, Jones Act exemptions in cases of emergency response incidents, and for highly specialized construction equipment, as discussed in Chapter 4.
- Recognizing the potential of unmanned aircraft to significantly improve current monitoring and sensing capabilities, all stakeholders should work with the FAA Investigative Program to support permitting the use of unmanned aircrafts in the Arctic. This technology is currently available and would improve safety and efficiency of logistics support, oil spill response, ice characterization, and environmental monitoring.
- NOAA should maintain at least the current capability of polar observing weather satellites and evaluate the merits of a new U.S.-controlled synthetic aperture radar satellite accessible by all stakeholders.
- Individual companies should continue/increase discussion with local communities, state and federal agencies, and Alaska universities on workforce requirements for all sectors and implementation plans.

## INTRODUCTION

### Purpose and Objectives

This chapter reviews logistics and infrastructure requirements and challenges and risk management

practices, and it identifies opportunities for enhancements in support of prudent development in the Alaskan Arctic. Opportunities are broadly considered and include technological advances, collaborative investments, proactive planning and permitting, and the research needed to enable efficient planning and permitting. There are vital roles for government institutions at the local, state, and federal levels in these activities.

For definition purposes, logistics encompasses all of the measures and capabilities needed to manage the supply chain for an exploration/development project or an ongoing operation. The supply chain provides people, material and equipment, food, fuel, spare parts, communications, etc., and also manages wastes. Infrastructure generally means the fixed land-based facilities that support the supply chain for maritime-based activities and operations. Infrastructure includes ports, roads, airfields, communication networks, housing, and supply depots. Logistics requires access to both ends of, and all points along, the physical supply chain. As the ease of physical access improves, logistics generally become simpler, timelier, and more efficient. The ease of physical access relies heavily on the availability of supporting infrastructure.

Existing logistics assets and the current state of Arctic infrastructure are assessed for their ability to maximize year-round operability for the study area. Priority is given to infrastructure that could potentially be used to support future offshore oil and gas activities, consistent with the proposed focus on offshore resource development. A holistic perspective is taken that considers all stakeholders (public, federal/state government, military, and private industry outside of the oil and gas sector), recognizing that infrastructure can be designed to maximize the benefits of the capital invested and minimize operating expenditures for all parties involved.

Robust logistics solutions are needed to responsibly compensate for the physical environment and a general lack of existing infrastructure in the Alaskan Arctic. Challenges of remote regions to efficient logistics and infrastructure include sparse population centers compounded by minimally developed roads, railroads, pipelines, airfields, deepwater ports, large-scale electrical power generation and distribution, and communications facilities.

In the Arctic environment, effective risk management is essential to protecting fragile ecosystems and to respecting local cultures while at the same time striving to meet cost, schedule, and technical objectives. Risks must be identified, analyzed to such an extent that they are adequately understood, and actively managed by preferably eliminating them in advance or by providing effective measures to mitigate them should they materialize during project execution. Logistics and infrastructure challenges are at the heart of a number of project risks in the Alaskan Arctic. Many of these challenges have been robustly managed over the past six decades in other Arctic operations, such as the North Slope.

A recent study by the University of Alaska Fairbanks<sup>2</sup> defined and estimated the infrastructure needed to support oil and gas activities as including buildings of various types, roads, gravel islands, docks, causeways, airstrips, pipelines, power lines, wells, mines, and landfills for the existing North Slope Alaska developments. This is a fairly inclusive definition that also works well for the purposes of this report. Both offshore and onshore oil and gas exploration, development, and production activities rely to some extent on land-based infrastructure.

## Scope

The scope of this chapter includes:

- Land access and onshore infrastructure
- Pipeline infrastructure
- Maritime port infrastructure
- Maritime assets and alternatives
- Aviation assets, infrastructure, and alternatives
- Communications infrastructure
- Remote sensing infrastructure
- U.S. Armed Force synergies
- Alaskan Native synergies.

## Non-Oil and Gas Interdependencies

Infrastructure, and especially infrastructure expansion, is of potential value to many stakeholders beyond the oil and gas industry including both

public and private interests. Public interest would be from local communities, the state of Alaska, and federal government and specifically the U.S. Navy and U.S. Coast Guard. Commercial interest includes the shipping, tourism, and fishing industries. A common theme in this report is the opportunity for strategic planning to recognize these synergies.

## Physical Context

A brief summary of the physical challenges of the Alaskan operating environment is provided for context. Key parameters include remoteness, extreme temperatures, seasonal daylight extremes, seasonal ice, and visibility.

### Remoteness

A distinguishing characteristic of the study area is its remoteness as shown in Figure 7-1. This remoteness is due to both the size of Alaska as well as the distance between Alaska and the Lower 48 states, with key distance metrics summarized in Table 7-1. The distance, for example, from Seattle to Dutch Harbor, the deepwater port closest to the study area and the only deep-draft, ice-free port from Unimak Pass west to Adak and north to the Bering Strait, is 1,650 nautical miles, while the distance from Dutch Harbor to the Chukchi and Beaufort Sea is another 1,075 and 1,400 nautical miles respectively. To add further perspective, the flight time from Anchorage to Deadhorse (Prudhoe Bay) or Barrow is more than 2 hours.

There are communities along the north and west coast of Alaska that can provide limited support;

Seattle to:	Nautical Miles	Days to Destination at 10 knots
Dutch Harbor	1,650	7
Chukchi Sea Sale 193 Leases	2,725	11
Beaufort Sea, Camden Bay	3,050	13
Dutch Harbor to:	Nautical Miles	Days to Destination at 10 knots
Chukchi Sea Sale 193 Leases	1,075	5
Beaufort Sea, Camden Bay	1,400	6

**Table 7-1.** Distances from Lower 48 to Dutch Harbor and to Study Area

however, these communities are without deepwater ports, are inaccessible by land transport, and have limited onshore infrastructure such as communication networks and airfields relative to the needs of offshore exploration and development.

Several points of note:

- Resupply operations in Alaska involve long distances from a major maritime port or airfield.
- Resupplying an offshore facility becomes more of an issue when ice is involved. Icebreaking vessels can be used, but at certain times of the year there may be restrictions on their use due to wildlife and subsistence hunting.
- Many airfields in the North Slope do not have hard surface runways, limiting the aircraft types that can operate. Additional considerations are as follows:
  - There is limited or no local emergency response.
  - Most village airfields do not provide a full range of services, such as fuel.
  - The FAA has not established air traffic routing for offshore helicopter operations.
- There is only one road from Fairbanks to Prudhoe Bay, and only limited road access from Prudhoe Bay to northern Alaska municipalities, like Barrow, that are potential staging areas to support operations in the study area. Additionally, the Prudhoe Bay infrastructure is privately owned, including roads and dockage, creating usage constraints. Altogether, this makes Prudhoe Bay infrastructure of limited value to the study area.

- There is no rail infrastructure north of Fairbanks. The isolation of most population centers results in high costs for transportation services, infrastructure development, and maintenance support services.

### Extreme Temperatures

Alaska air temperatures for January and July are summarized in Table 7-2. Winter temperatures limit operational windows for outdoor activities for both people and equipment. Cold temperatures can require specialty materials, such as in the case of steel to avoid brittle fracture. Cold temperatures also impact aviation operations. The minimum operating temperatures vary by aircraft type, generally  $-32^{\circ}\text{F}$  to  $-40^{\circ}\text{F}$ , limiting use during the winter months.

### Seasonal Daylight Extremes

The high latitude of the study area results in extremes in both daylight and darkness. Darkness affects aviation operations and worker morale. During winter months, the sun drops below the horizon and “sets” for several months; however, twilight provides additional “light” as shown in Table 7-3 from the U.S. Naval Observatory model, so there is no time period of total darkness. Civil twilight, as shown in this table, is defined to begin in the morning and to end in the evening when the center of the sun is 6 degrees below the horizon. This is the limit at which twilight illumination is sufficient, under good weather conditions, for terrestrial objects to be clearly distinguished. The minimum, maximum, and average values are for the given month.

January (°F)	Barrow	Nome	Fairbanks	Anchorage
Monthly Average	-13.6	4.7	-10.2	15.8
Minimum Monthly Average	-26.4	-15.2	-33.3	2.2
Minimum Daily Minimum	-56	-54	-66	-39
July (°F)	Barrow	Nome	Fairbanks	Anchorage
Monthly Average	39.8	52.6	62.6	58.4
Maximum Monthly Average	45.5	58.1	67.5	62.0
Maximum Daily Maximum	79	86	94	86

Source: NOAA's National Climatic Data Center website.

**Table 7-2.** Air Temperature Data for January and July (Fahrenheit)

Month	Minimum	Maximum	Average
January	3:44	7:22	5:25
February	7:30	11:33	9:30
March	11:41	16:30	14:01
April	16:41	24:00	20:21
May	24:00	24:00	24:00
June	24:00	24:00	24:00
July	24:00	24:00	24:00
August	18:25	24:00	22:13
September	13:13	18:11	15:34
October	08:42	13:03	10:51
November	04:42	08:34	06:35
December	03:17	04:35	03:43

*Table 7-3. Civil Twilight Calculation in the Chukchi Sea for 163 30W, 71N*

### Seasonal Ice

Ice characterization is discussed in detail in Chapter 5 and key points needed to provide perspective on logistics and infrastructure requirements and constraints are recapped here. Seasonal ice affects maritime equipment selection and operational windows. The ice cycle in the study area as well as Bering Strait follows a similar pattern of formation, growth, decay, and open water, but dates vary depending upon location. Ice formation starts in September in northern regions of the Beaufort and Chukchi Seas, and by October landfast ice can be found along the coastline. By July, ice has disappeared in most shore regions of the Beaufort and Chukchi Seas with varying amounts of open water/low ice concentrations during the summer period. Ice formation in the Bering Strait and Norton Sound starts in early November and by late December the northern Bering Sea is ice covered. Ice reaches its maximum southerly extent by March. Ice decay starts in April and reaches the Bering Strait in May. Due to changing winds, large open water regions can be present during the ice season.

### Visibility

Figure 7-2, from the Alaska Weather Aviation Unit study, “MVFR/IFR Climatology for Selected Alaska TAF (Terminal Aerodrome Forecast) Sites,”<sup>33</sup> shows

the percentage of time per month that aircraft operations occurred under various flight rules at Barrow Airport from 1973 to 2007. The colored bars in Figure 7-2 represent progressive restrictions on flying conditions, with the green bar corresponding to Marginal Visual Flying Rules and the yellow, red, and blue bars corresponding to increasingly restrictive Instrument Flight Rules. This shows that the least restrictive flying weather occurs during the winter months, whereas exploration activities in the study area primarily occur in the summer months when flying conditions are most restrictive. Visibility can constrain flying both directly through required safety minimums and indirectly through potential impacts on wildlife and subsistence hunting and the requirement to meet minimum height ceilings.

## LAND ACCESS, ONSHORE FACILITIES, AND ROADS

This section considers land access, principally with regard to the unique characteristics of wetlands and regulations regarding wetlands use, onshore facilities, and roads. Construction materials, including sand, gravel, and rock important for onshore facility construction, roads, and ports, are covered in the subsection on roads.

### Land Access

Land access is a key enabler for all onshore infrastructure including roads, onshore facilities, pipeline corridors, ports, airfields, and communication physical assets. Land access is also important for extracting gravel for onshore construction, including roads and pads that support facilities by protecting the underlying permafrost from melting. Land access is critical for infrastructure, including roads, onshore facilities, ports, airfields, pipelines, and communication networks.

### Current Landscape

As seen in Figure 7-3, the U.S. government is the largest landowner in the state of Alaska, with federal ownership of more than 60% of Alaska’s 365.5 million onshore acres. In addition, Alaska’s coastline accounts for more than half the miles of coastline of the entire United States, and all the waters outside of Alaska’s 3-mile territorial limit are under federal control.

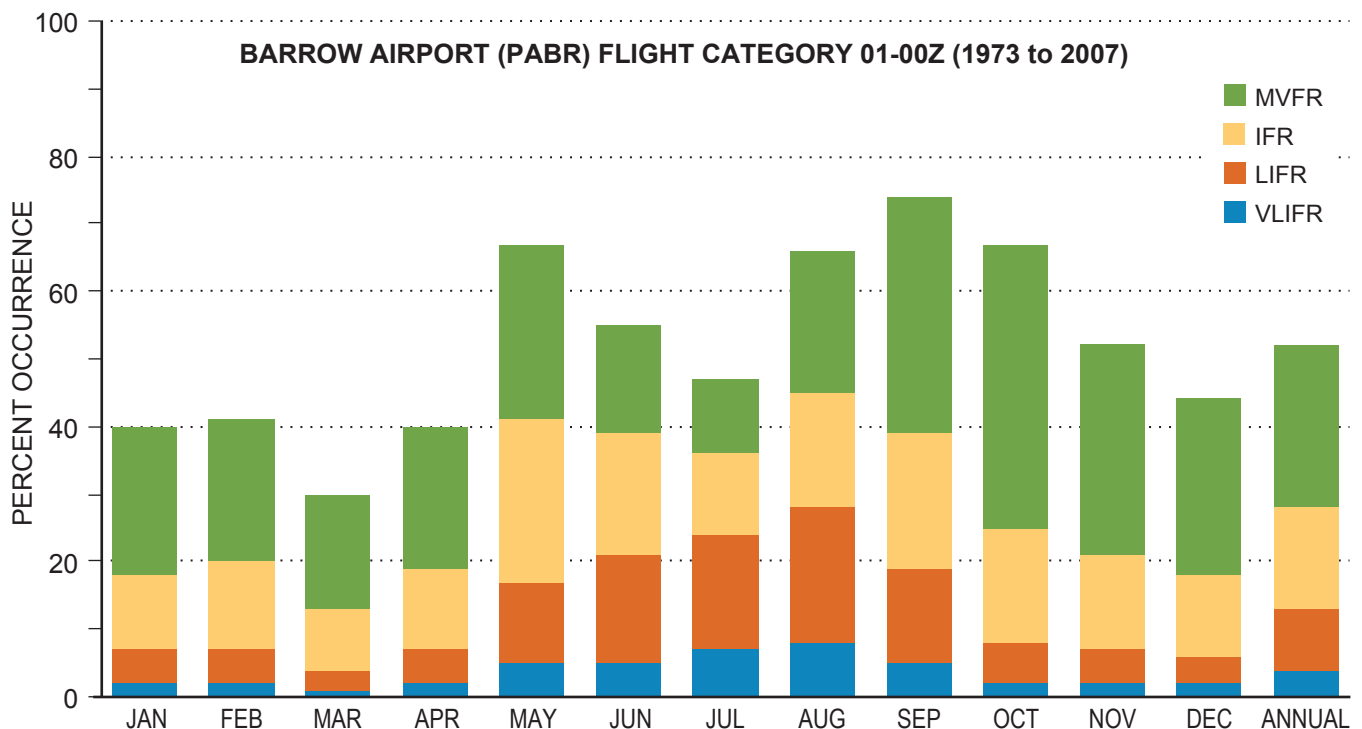

The visibility categories:

MVFR – Marginal Visual Flying Rules defined as a cloud ceiling between 1,000 and 3,000 feet and visibility between 3 and 5 statute miles

IFR – Instrument Flight Rules defined as a cloud ceiling < 1,000 feet and visibility < 3 statute miles

LIFR – Low Instrument Flight Rules defined as a cloud ceiling < 500 feet and visibility < 1 statute mile

VLIFR – Very Low Instrument Flight Rules defined as a cloud ceiling < 200 feet and visibility < 0.5 statute mile

Source: Alaska Weather Aviation Unit study, “MVFR/IFR Climatology for Selected Alaska TAF Sites.”

**Figure 7-2. Percentage of Time Per Month That Given Visibilities for Aircraft Operations Occurred at Barrow Airport**

Much of this surface land is considered wetlands, with this designation covering approximately 174 million acres, or about 43% of Alaska’s surface area.<sup>4</sup> Since almost half of Alaska is considered wetlands, nearly every development project in Alaska, particularly in northern Alaska where onshore support for offshore development is likely to occur, will require permitting and some form of wetlands compensatory mitigation.

State lands sandwiched between the National Petroleum Reserve–Alaska (NPR-A) and the Arctic National Wildlife Refuge (ANWR) provide access to the North Slope from the rest of Alaska and the Lower 48 and Canada via the Dalton Highway. The largest dock north and east of Point Hope is also on these state lands.

Under the present management practices of the NPR-A and the ANWR, the ability to access the corridors necessary for the efficient and economic

development of offshore production of oil and gas is challenging because of existing land use restrictions (e.g., the 2013 Record of Decision for the final NPR-A Integrated Activity Plan/Environmental Impact Statement<sup>5</sup> covering management of the 23 million acre reserve).

### Prudent Development Context

Some amount of land access is necessary for resource development. Responsible land development is important to local communities and the state of Alaska due to the economic benefits gained, including royalty payments, property taxes on infrastructure, and jobs. Land access needs to be balanced with risks to the ecological and human environments: first through a focus on the potential for environmental damage and second on the increased accessibility to communities that are currently without road access and the advantages and disadvantages that come with road access.



## Future Aspirations and Options to Achieve

Specific recommendations are made in Chapter 4. Additionally, the following enhancement opportunities are seen:

- A programmatic environmental impact statement might be considered to support onshore and offshore oil and gas exploration and development and other commercial/industrial activities on the North Slope.
- Additional wetlands research could help decision-making with, for example, developing a statewide mitigation plan and a more flexible and effective regulatory approach where all mechanisms of wetlands mitigation are considered, including mitigation banking, in-lieu fee mitigation, and permittee-responsible mitigation.

## Onshore Facilities

Onshore facility requirements include housing, equipment, storage, power generation, pipeline pumping and compression stations, and oil and gas processing facilities. Construction and support of onshore facilities in the Alaskan Arctic is challenging and expensive. The oil and gas industry typically relies on prefabricated housing/office/warehouse units to overcome the limited construction/transportation windows. Industry also relies on modularization for process equipment, again to deal with the challenging construction conditions.

## Current Landscape

Supporting these facilities is a challenge due to limited transportation infrastructure. Access is often only by seasonal ice roads, seasonal barging, or air, and access can often be interrupted by weather conditions. The coastal waters off Alaska are typically shallow and there are no deepwater docks north of the Bering Strait to allow transportation of large amounts of heavy cargo directly to the region. This requires extensive planning and logistical support to ensure supplies are where needed, when needed. Additionally, there is typically no or limited power or telecommunications available. These issues must be addressed during future development.

## Prudent Development Context

Onshore facilities need to consider both separation from local communities for safety, security, and

esthetics, and potential synergies, including road and air access, power, and communications. Efficiency of land use, consumables, and power requirements are all important factors in enhancing prudent development.

During the initial development of the Prudhoe Bay Oil Field, individual oilfield support contractors leased state land and built gravel pads, camps, maintenance facilities, shops, and related infrastructure to support company specific operations, creating the unincorporated community of Deadhorse. This resulted in inefficient development patterns, inconsistent quality of facilities, and at times no clear accountability for site maintenance and removal of outdated facilities and equipment. By default, emergency response became the responsibility of the adjacent oilfield operator. On the other hand, when the Kuparuk oil field was developed 40 miles west of Deadhorse, an industrial authority was formed to concentrate these services under a central authority, providing leased gravel pad space, shop facilities, office, and camp to oilfield support contractors. As a result contractors providing oilfield support are able to operate without the need to first develop their own stand-alone support facilities. This planned approach for support facilities at Kuparuk minimized both land use requirements and environmental impacts related to development. In addition, these support facilities offer an opportunity for local community ownership and employment, and often cross the boundary into traditional municipal services like waste management, emergency response, and power generation as examples.

## Future Aspirations and Options to Achieve

Ideally, the cost efficiency of remote onshore facilities will improve as infrastructure grows to support development of resources. This may include roads in select circumstances, airstrips, improved search and rescue and emergency response capabilities, improved communications infrastructure (possibly along pipeline right-of-ways), and access to power.

A specific onshore opportunity is seen in the area of power generation. Hybrid and microgrid power systems have the opportunity to increase fuel efficiency and reduce emissions through the use of stored energy to meet peak load demands. These technologies have advanced meaningfully in the past 5 years, driven by military research for battlefield applications. An

example of the relationship between emissions and fuel consumption and load factor is shown in Figure 7-4 for a marine engine.<sup>6</sup> Load factor is defined as the average load divided by the peak load. Emissions and power consumption vary inversely with load factor, so technology that increases load factor will improve environmental performance.

The net result of improved reliability and efficiency is a reduction in the environmental impact of power generation in remote Arctic logistics and infrastructure. Enhancement opportunities include:

- Development of hybrid and microgrid technologies to optimize electricity generation in the sparsely populated Arctic regions
- Development of communications and power systems in areas where both a local population and a long-term industry operation would benefit from combined resources
- Industry, local, state, and government agencies could coordinate infrastructure planning by carrying out where possible joint scenario planning to identify mutual needs.

## Roads

Roads are important to the oil and gas industry because they enable a continuous logistics supply chain. Temporary or permanent roads are also important for onshore pipelines and other onshore facilities because they afford access to materials, equipment, and people during construction and for inspection and maintenance during operation.

### Current Landscape

In areas of permafrost, roads are constructed by building up a roadway from gravel of sufficient thickness to keep bearing capacity within allowable limits and to provide thermal protection against thaw. Use of thermal barriers can reduce the required depth of gravel.

Figure 7-5 shows a section of the DeLong Mountain Transportation System (DMTS), a 30-foot all-weather gravel industrial haul road from the mine site to the port facility. The Red Dog Mine is located in the DeLong Mountains of the Brooks Range, 82 miles north of Kotzebue, 55 miles from the Chukchi Sea, and 106 miles above the Arctic Circle.

There is a fair body of work indicating that east of the Colville River construction resources are sufficiently abundant and of high-enough quality to support development activities. Construction materials in this area are located in modern alluvial valleys and along modern rivers and in young, unconsolidated bedrock units, as well as in glacial outwash deposits closer to the Brooks Range. However, there is high degree of uncertainty on the quantity and quality of sand, gravel, and rock resources between Chukchi Sea and Dalton Highway. There is very little publicly available data on the quantity and quality of materials of these various deposit types; however, geologic formations are present in the NPR-A and Chukchi Sea areas that elsewhere contain usable construction materials. This suggests that exploration may be able to locate sufficient materials to support oil and gas development, but at this point the level of information is insufficient to say whether or not the resources are present. The availability of more complete information would greatly inform this discussion.

During the winter season, temporary ice roads can be constructed to facilitate construction and/or resupply of existing facilities. These can be offshore or onshore ice roads. Onshore, the roads are constructed by using snow, ice aggregate, and water to create an ice roadbed of approximately 6 inches. The roadbed is laid on top of the ground. The ground/tundra is not disturbed or graded. This will typically allow the transit of trucks and equipment as well as passenger vehicles. At the end of the season, road markers, temporary culverts, etc., are removed. Any ice bridges across water are also removed to ensure natural water flow as temperatures increase.

The state of Alaska's Roads to Resources Program Initiative (R2R) works with state agencies, resource developers, and other interested parties, including local governments and Native corporations, to design and build projects that support development of natural resources in the oil and gas, alternative energy, mining, timber, fisheries, and agriculture industries. In addition to traditionally funded public projects, R2R anticipates and analyzes prospects for public-private partnerships to fund projects that will generate enough revenue to pay off planning and construction costs.

The DMTS is an example of the R2R program: the Alaska Department of Transportation and Public

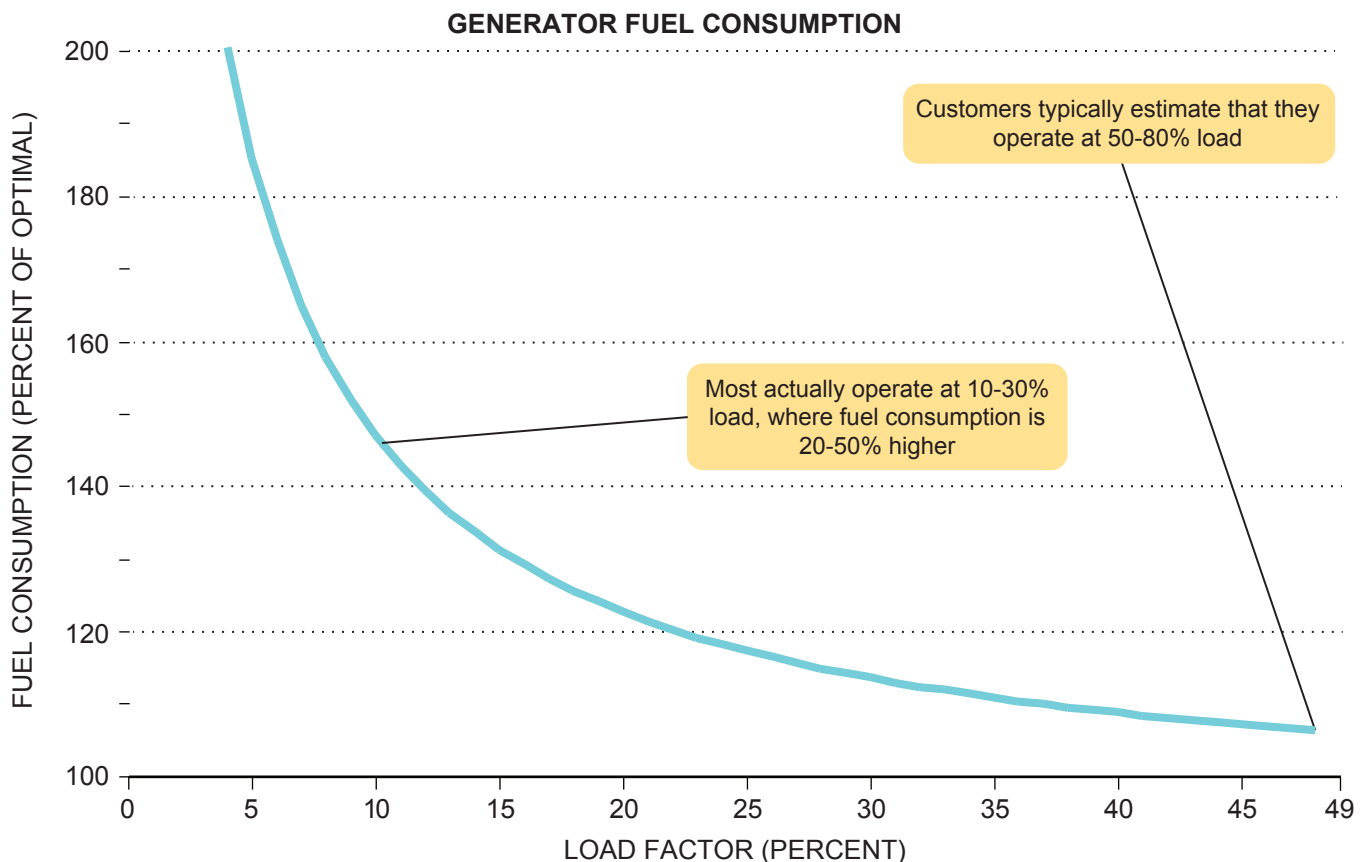
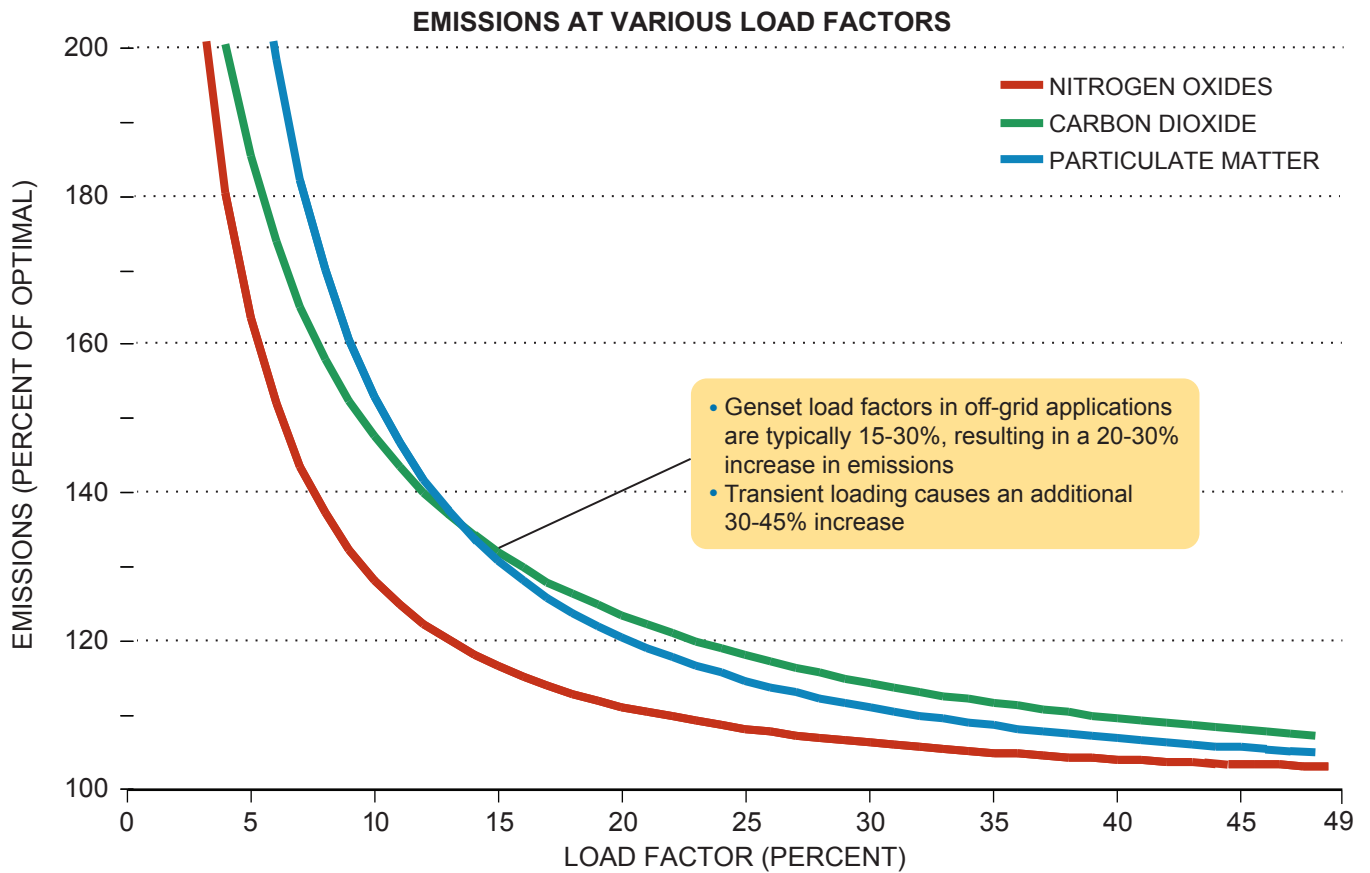

Source: Environmental Protection Agency.

**Figure 7-4.** Example of Marine Engine Emissions and Fuel Consumption as a Function of Load Factor



Note: The DMTS was built by the Alaska Industrial Development and Export Authority and is operated by Teck Alaska Incorporated.

Photo: Teck Alaska Incorporated.

**Figure 7-5.** *Transporting a Grinding Module to the Red Dog Mine on the Delong Mountain Transportation System in 1989*

Facilities worked with the mine landowners, Cominco Mining Corporation, the Northwest Alaska Native Association, the National Park Service, and Congress to establish a road on federal land. The department, coordinating with the Alaska Industrial Development and Export Authority, constructed the road from 1987 to 1990.<sup>7</sup> The R2R program has achieved success, as shown by the DMTS example, and is positioned for future opportunities as Alaska's rich natural resources continue to be explored, developed, and used in a manner that best serves all stakeholders.

Off-road travel is a significant mode of winter transportation for both onshore exploration and construction of onshore facilities and pipelines. The Alaska Department of Natural Resources has developed significant experience over the past 30 years in permitting and managing off-road travel on the North Slope tundra. The department has developed science-based methods for determining when it is environmentally appropriate to travel across tundra and by which means. These methods have allowed the lengthening

of the oil and gas exploration season for the North Slope while protecting the tundra.

### **Prudent Development Context**

New roads can have both long-term socioeconomic advantages and disadvantages in this vast, largely road-free region. Route selection performed with only a single project in mind may not identify the route that would also maximize the potential for overall economic development in the region. A responsibility of the local and state government in consultation with local stakeholders is to ensure that broader road access and societal interests that may be for and against access are considered in road planning. When evaluating a road permit request, a governmental authority may impose additional requirements that are external to the needs of a particular project in order to achieve broader outcomes. Such requirements can lengthen project schedules and increase costs, particularly if they are imposed later in the project design cycle.

Gravel resources are typically found near major river drainages in both active and abandoned channels. Suitable gravel has been found available for the existing onshore oil and gas infrastructure. However, gravel availability for infrastructure development is expected to be problematic between the Colville River and west to the Chukchi coast due to lack of drainages.

### Future Aspirations and Options to Achieve

The following opportunities for enhancement should be considered:

- Governments at all levels should consider supporting implementation of the Roads to Resources Program. The totality of the areas supported by the R2R program is significant, as will be the costs to tie all remote locations into major transportation hubs.
- Industry, local, state, and government agencies should coordinate infrastructure planning by carrying out, where possible, joint scenario planning to identify mutual needs.
- The federal government and the state of Alaska should consider performing a joint study of sand, gravel, and rock resources and their prudent use across the North Slope.

## ONSHORE PIPELINE INFRASTRUCTURE

### Current Landscape

Onshore pipelines have been successfully installed and operated in Arctic environments for many years. Most notable in Alaska is the Trans-Alaska Pipeline System (TAPS). TAPS has been in service since 1977, safely and reliably transporting crude oil from Prudhoe Bay and other Alaska North Slope oil fields over 800 miles to the Valdez deepwater maritime terminal (Figure 7-6). Alyeska Pipeline Service Company (Alyeska) was formed in 1970 to design, build, maintain, and operate TAPS. The pipeline today is recognized as a landmark engineering feat and remains essential to Alaska’s economy and central to the state’s industry.

In addition, a number of smaller common carrier oil pipelines connect various North Slope Alaska oil fields to TAPS at Pump Station 1. At present, these

common carrier pipelines connect remote production from as far as the Alpine Oil Field, 60 miles west of TAPS, and the Point Thomson field under development 60 miles to the east of TAPS. A gas pipeline has been proposed from Prudhoe Bay to an LNG (liquefied natural gas) plant in Nikiski. This project is in the concept selection stage and design aspects are still being refined. The current plan is to install the pipeline underground and chill the gas to keep the thaw-unstable soils frozen and thereby protect the permafrost and the pipeline. This is a major capital project that still has many regulatory and fiscal hurdles to overcome, but a large-scale pipeline together with an LNG export facility is a way to monetize the currently stranded gas.

Alaska has also seen limited use of railcars for hydrocarbon transportation. The rail system is limited in scope to a single combined passenger/freight line connecting Seward and Whittier to Fairbanks and the Eielson Air Force Base. Before TAPS, this rail system was used to supply the interior of Alaska with fuel for heating, electricity, and transportation. This changed in 1977 when the North Pole Refinery in Fairbanks went into operation, drawing crude oil



Source: Shell.

**Figure 7-6.** The Trans-Alaska Pipeline System Route Map

from TAPS to supply the interior with fuel products. In 2014, this refinery ceased operating and has been converted into a distribution terminal. The railway is once again being used to import fuel products to interior Alaska.

### **TAPS Construction and Operation**

Constructed from 1974 to 1977, this pipeline (Figure 7-7) used the best technology available at the time to protect the fragile permafrost and provide migration corridors for wildlife while maintaining operating temperatures and pressures that would ensure reliable transport of crude oil. As mentioned earlier, the pipeline is owned and maintained by the Alyeska Pipeline Service Company, which was formed in 1970.

Arctic overland pipelines face unique design, construction, and operation challenges. Rigorous design, construction, and operational planning factors must be considered to help assure the success of any overland pipeline in the Alaskan Arctic.

TAPS is a 48-inch diameter oil pipeline traversing an 800-mile route through three mountain ranges and across numerous rivers and streams from the Prudhoe Bay Field on the North Slope to an ice-free, deepwater shipping terminal at Valdez. Although both oil and gas discoveries have been made in the North Slope, only oil production and export has been enabled by the TAPS.

A key design consideration was seismic loading and fault crossings. On November 3, 2002, the magnitude 7.9 Denali Fault earthquake centered near Paxson, Alaska, caused a lateral shift of 2.5 meters horizontally across the fault line where TAPS crossed the fault zone. TAPS was designed to accommodate a shift of this size through the use of slide supports and consequently did not suffer any damage. This demonstrates that Arctic overland pipelines can be—and have been—designed, built, and operated safely in seismically active areas.

TAPS average daily throughput is shown in Figure 7-8. Since peak flow in the late 1980s, TAPS



Photo: ExxonMobil.

*Figure 7-7. Section of TAPS During Winter*

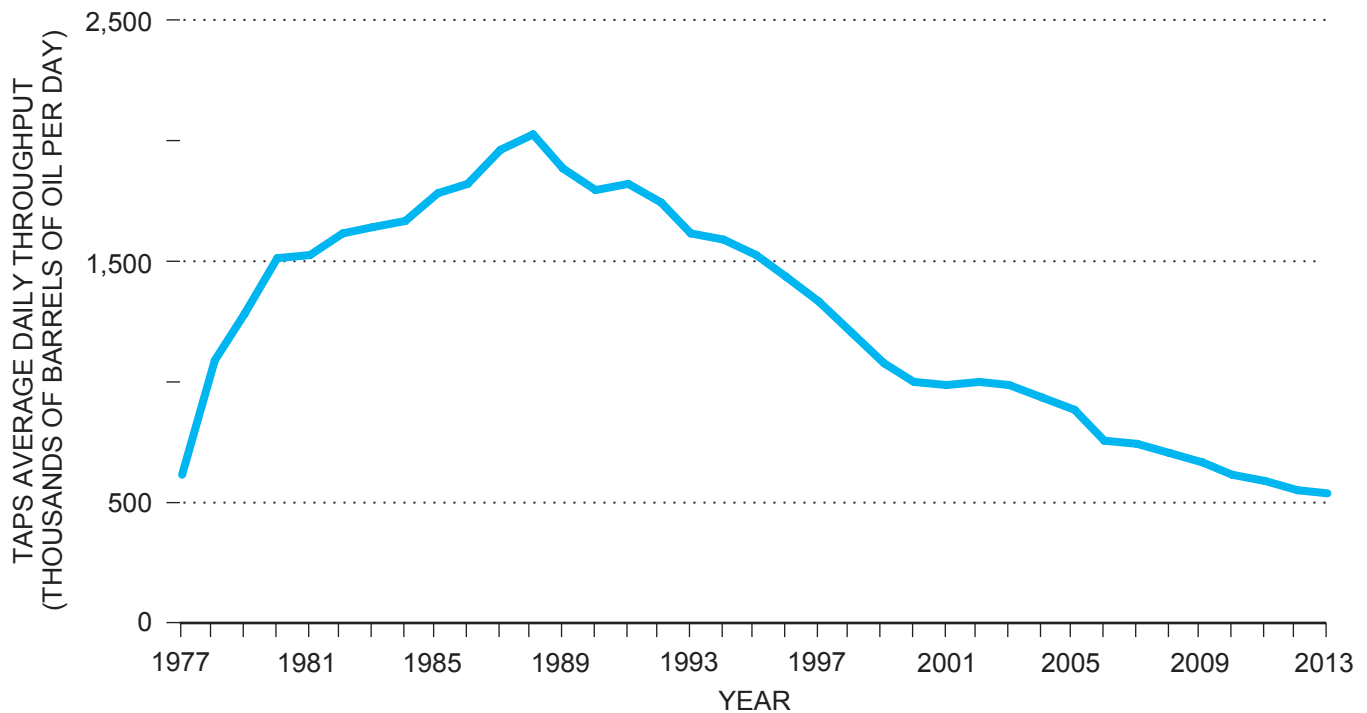

Source: Adapted from Alyeska Pipeline Service Company “Low Flow Impact Study” report and website data, <http://www.alyeska-pipe.com/TAPS/PipelineOperations/LowFlow>.

**Figure 7-8. TAPS Throughput**

throughput has been declining by more than 5% per year. Less oil means slower-moving oil. Slower oil means colder oil. And the slower and colder the oil, the more complicated the operating challenges. Daily throughput is now lower than it was at pipeline startup in 1977.

### TAPS Life Extension

The useful life of TAPS will be determined by both its physical life and its economic life. The physical life can be extended as long as the integrity of the pipeline and facilities is maintained adequately to allow continued safe and environmentally sound transport of crude oil. The economic life, however, will be determined by how long it can attract shippers and provide its owners with a reasonable economic return.

The best long-term solution for extending the useful life of the TAPS is finding more oil to transport. Lower flow rates present significant operational challenges for the pipeline system. Recent

major pump station modifications allow greater flexibility in managing lower and variable flow rates. Additionally, recent modifications allow for recirculation of the crude oil to add heat and maintain crude oil temperatures above 32°F. It is important to maintain temperatures above freezing to prevent water in the pipeline from forming ice that would block flow. If operation is required below freezing, the oil would require significantly more dehydration or chemical additive. Nonetheless, as flow rates and crude oil temperature continue to decline, practical limits will be reached in the ability to maintain operating temperatures above freezing. Planned mitigations are expected to enable reliable operations down to 300,000 barrels of oil per day or possibly lower.

Alyeska is continuing to research and implement adjustments necessary to operate TAPS safely and efficiently so that TAPS will remain a viable component of Alaska’s economy and the nation’s energy infrastructure.

## Prudent Development Context

### Economic

Oil and gas development is one third of the state of Alaska's economic activity and provides about 90% of the state's general revenue. Oil flowing through the TAPS is a major contributor to this revenue.

### Design

Pipelines operating at above 32°F are typically designed to be supported on above-ground vertical support members to protect thaw-unstable permafrost ground. These pipelines can also be buried in thaw-stable permafrost material but proper geotechnical evaluation of the ground conditions is critical. Over marginal permafrost areas, passive cooling thermosiphons are often used to maintain ground temperatures below freezing around the vertical support system members to avoid ground failure from thawing. Mechanical refrigeration schemes may be required at road crossings or special configurations. These pipelines are preferentially buried wherever thaw-stable ground conditions exist.

Pipelines operating below 32°F can be directly buried in permafrost zones but have the opposite consideration in marginal permafrost or thaw-unstable ground where the pipeline may cause excessive frost heaving. The correct characterization of ground conditions is critical to selecting the most reliable and cost-effective design for a given pipeline route.

In the Arctic coastal plain, rivers are typically braided with flow channels that change over time. Pipeline route selection must consider these long-term changes and include river crossing methods suited to each location. Current practice has used directional drilling below river crossings, pipe bridges, suspension bridge systems, and simple piling supports. All of the above-ground systems have to be designed for the high-peak spring break-up flow rates, related ice damming loads, and scour. Directionally drilled crossings require stable ground conditions and have to deal with permafrost transition zones.

Special consideration needs to be given to seismic risks and fault zone crossings and avalanche and

unstable side slope areas. The latter pose a significant risk to above ground pipelines, requiring route selections to avoid these high-risk zones. Clearly defining these areas on pipeline routes and selecting the needed design allowance is an important consideration.

Wildfire risks to elevated sections of pipelines are typically addressed by maintenance programs of brush removal along the right-of-way to minimize fuel and limit the highest temperatures that could be encountered from wildfires, which often burn uncontrolled in these remote areas.

Wind- and flow-induced vibration fatigue risks need to be modeled and addressed through the appropriate mitigation methods.

Pipeline construction in the Arctic has to deal with both the environmental conditions of cold and related seasonal limitations as well as the remoteness and limited transportation infrastructure. The nearest U.S. deepwater port is Dutch Harbor, more than 1,000 miles from south of the Chukchi Sea, and the shallow bathymetry across the entire north coast of Alaska does not offer the opportunity to effectively develop one. Winter ice road supply and ice construction pads must be built each season. Access to gravel resources to develop permanent pads or local roads is limited or nonexistent in many areas. The location of required roads, airstrips, or pads will likely mean long haul distances.

Permanent versus temporary transportation infrastructure decisions, while not a technical challenge, will drive project economics. Therefore consideration must be given to the role of local, state, and federal governments in providing these resources for common use.

### Operations

Due to the high costs and risks associated with maintaining personnel in remote locations, fully automated unmanned facilities are desirable to the maximum extent practical. Pump or compressor stations are remotely controlled and monitored. Alyeska Pipeline recently upgraded its pump station equipment and control system to more completely allow unmanned operations. Unmanned operations require highly reliable and redundant communications and control networks.

Ongoing pipeline operations activities also require highly reliable communications and control to support leak detection and monitoring, integrity inspection, surveillance, and security systems. Shutdown and restart requirements are more complex for long sections of pipeline in remote locations with difficult direct access.

Emergency response capability typically requires prepositioned materials and equipment to be maintained along the pipeline alignment.

### **Socioeconomic**

Pipeline route selection can have broad long-term socioeconomic impacts to this vast roadless region. Route selection appropriate for a single project may not be the route selected to maximize the potential for overall economic development in the region. These route selection factors can impact project schedules and cost estimates since they often come in later in the project design cycle during the permitting process, which typically introduces considerations beyond the single project.

### **Future Aspirations and Options to Achieve**

Keeping TAPS flowing is important to the economic livelihood of the state of Alaska. Ongoing inspection, maintenance, and life extension is being carried out by the Alyeska Pipeline Service Company, as the pipeline owner. Infrastructure planning for future oil exploration and development needs to consider TAPS as a valuable resource.

The technology supporting Arctic onshore pipelines is well understood and benefits from many years of successful operations both in Alaska and other Arctic regions. There are, however, several areas where advancing both basic research and furthering current practice can support access to more difficult and remote frontier regions for operations.

The following enhancement opportunities are seen for research by industry, academia, or government singularly or in collaboration.

- Improved passive thermosiphon design for heat removal: Technology enhancements would also be of benefit to residential, commercial, and public structures. These structures are at risk of founda-

tion damage due to permafrost melting and technology enhancements could have benefit to these structure types as well.

- Improved automated surveillance and security technology.
- Improved data gathering using unmanned aircraft technology for pipeline routing and monitoring activities.
- Adaption of advanced technologies (e.g., micro-electromechanical systems) for enhanced pipeline integrity monitoring and leak detection.

## **MARITIME PORT INFRASTRUCTURE AND NAVIGATION**

This section considers maritime port infrastructure, port alternatives, and maritime navigational safety.

### **Maritime Ports**

Maritime ports are important for exploration and development for resupplying, safe berthing of drilling and support vessels when not operating, vessel maintenance and repair, as forward bases for emergency response, and for oil and gas export. Ports are typically connection points between land-based infrastructure and water. Drilling operations in the Arctic will need to be resupplied with essential stores during the drilling season to ensure operations run on a continuous basis. These may include consumables such as food, drill pipe and other tubulars, and drilling fluids, as well as the crew to operate the rigs and support vessels.

### **Current Landscape**

Alaska hosts relatively few deepwater maritime ports, let alone ports with land access, even with its vast coastline. Outside of Southeast Alaska, the only deep-draft ports and associated maritime facilities are located in Anchorage, Seward, Kodiak, Unalaska (Dutch Harbor), Adak, Homer, Whittier, and Valdez. For reference see Figure 7-1.

The port of Dutch Harbor in Unalaska is the closest deepwater port to the study area but is 1,100 nm from the Chukchi Sea. Dutch Harbor, while not ideal because it is an island and its predominant industry

is fishing, has served as a port facility for oil and gas exploration since the 1980s when it was used as support base by Arco for drilling several Continental Offshore Stratigraphic Test wells in the Bering Sea.<sup>8</sup> Figure 7-9 is a picture of the Captain's Bay portion of the Dutch Harbor complex and the location of industrial wharfage.

Adak, with its retired military infrastructure, is of potential interest for oil and gas activity but like Dutch Harbor is only maritime and air accessible and would require significant investment to upgrade its facilities to serve the requirements of oil and gas activity. Anchorage, Seward, Kodiak, Homer, Whittier, and Valdez are impractical for logistical support due to their distance from the study area.

The Valdez Marine Terminal (Figure 7-10) at the south end of the Trans-Alaska Pipeline System was designed for loading crude oil onto tankers and includes provisions for enough storage to allow North Slope production to continue even when maritime transportation is interrupted. At the terminal, shown in Figure 7-10, crude oil is measured and stored and

then loaded onto tankers and transported to market. Tankers tie into a berth and oil spill containment booms are placed around the berth and tanker before oil is transferred through the loading arms onto the tanker. The first cargo of oil departed from Valdez on August 1, 1977, and since that time more than 20,000 tankers have been loaded there.

Port infrastructure in the Alaskan Arctic is the subject of the Alaska Deep-Draft Arctic Port System (ADDAPS) Study. The ADDAPS study area is shown by the yellow highlighted locations in Figure 7-11 and includes more than 3,000 miles of coastline, which is roughly one and a half times the length of the eastern coast of the United States from Canada to the tip of Florida. This 3-year study is being conducted by the state of Alaska and the U.S. Army Corps of Engineers. The study is planned to be finalized in 2015. Initial findings published in 2013<sup>9</sup> provide the following results and insights:

- Large-vessel traffic passing Alaskan shores is increasing, and more than 60% of these vessels are foreign-flagged. Increased traffic means increased



**Figure 7-9.** *Captain's Bay, Unalaska, Alaska*

Photo: Shell.



Photo: Alyeska Pipeline Service Company.

**Figure 7-10. Valdez Marine Terminal**



Source: U.S. Army Corps of Engineers, *Alaska Deep-Draft Arctic Port System Study*, March 2013.

**Figure 7-11. Study Area for ADDAPS Study**

risk of incidents that would call for a response by the U.S. Coast Guard and other available vessels. In this regard, the United States and other members of the Arctic Council agreed to support search and rescue in the Alaskan Arctic in a May 12, 2011, international agreement.

- The need to support federal sovereignty over Alaska waters is growing in light of increased international interest (i.e., foreign trade and resource development) in the Arctic.
- The importance of ensuring adequate environmental protection and response increases as maritime traffic increases and oil and gas development grows in the Chukchi and Beaufort Seas.
- Addressing these issues effectively requires further development of Alaskan ports generally, and specifically development of one or more deep-draft ports in much closer proximity to the North Slope. (Note: The North Slope was one of the five geographic regions being studied; the other regions were the Bering Strait, Norton Slope, Pribilofs, and Southwest Alaska.)

The technical feasibility of building and operating marine oil offloading terminals in Arctic areas has been established through successful experience in a wide range of port facilities—from the temporary seasonal loading of double-hulled OBO (Ore/Bulk/Oil) icebreaking ship *MV Arctic* at Bent Horn, Cameron Island, Canada (1985-1996), to the more recent Varandey marine terminal in the Barents Sea and Sakhalin-2 LNG terminal in Prigorodnoye (Sea of Japan). Most of the coastal areas in northern Alaska have shallow water depths for which offshore terminals could be more cost effective.<sup>10</sup> These areas will also be impacted by offshore ice.

### **Prudent Development Context**

Ports are typically shared with other commercial and local entities requiring their services. The impact of energy exploration operations brings both positive and negative impacts to local communities. Positive impacts are derived from significant economic benefit from leasing arrangements with local corporations and governments. Negative impacts manifest themselves in competition for resources (dock and hotel space, fuel requirements, waste and material throughput, and community interaction with contract workers) and have to be carefully understood, planned, and managed.

Key planning factors for future port facilities should include the following:

- Capacity, both in terms of overall size and water depth, to support current and future operational requirements
- Geographic location to support current and future oil and gas operations
- Access restrictions due to seasonal ice and other limitations
- Access to multimodal combinations including air, land, sea, and rail
- Environmental and socioeconomic impacts and proximity to workforce
- Demand, including government, public, and private users
- Geomorphic resilience and protection from harsh environmental conditions (wind, seas, ice, tides, currents).

### **Future Aspirations and Options to Achieve**

Ideally, resupply would be completed from deep-water ports with short supply runs in fair weather. Unfortunately, most Alaska ports north of the Bering Strait provide only shallow draft access and inclement weather often restricts the ability of smaller vessels to transit offshore. Limited access to deepwater ports often necessitates long supply chains that require multiple offshore supply vessels to ensure reliability. This presents considerable challenges, including increased cost and decreased availability.

Construction of a suitable deep-draft port could serve the interests of both the oil and gas industry and a much broader community of state, federal, and local stakeholders. Individual companies cannot alone finance or construct a deepwater port due to the cost and environmental sensitivities; this would require the government as a partner.

On that basis, the Deep-Draft Arctic Port System Study final report due in 2015 should be reviewed and the detailed functional requirements of all potential users considered. This, in turn, could lead to the following additional outcomes:

- Feasibility analysis of shortlisted sites using physical criteria and alignment with potential investors,

public-private partnerships, future development, and port management authority<sup>b</sup>

- Strategic investment to enhance the Arctic ports system to provide deep-draft solutions for resource development, export and support, as well as improvements appropriate for the U.S. Coast Guard, environmental protection (oil spill response), search and rescue, and community resupply
- Assignment of lead federal agency responsibility for permitting, design, and construction of the Alaska deep-draft arctic port system
- Encouragement of public and private entities to collaborate in funding and constructing marine infrastructure using the strengths of each sector to achieve success through public-private partnerships
- Initiation of a programmatic environmental impact statement for a deepwater port/expanded port system to ensure the least impact to marine and terrestrial habitats, migrations, and Native hunting.

## Port Alternatives

In the absence of a suitably located deepwater port, a possible way to optimize the supply chain would be to use dedicated ships or barges to provide services that are otherwise available at a port (the “ware ship” concept). Port alternatives can provide some but not all of the benefits of existing and new ports. These alternatives and new port infrastructure are not mutually exclusive, meaning that they could be used either in lieu of or in addition to new port facilities.

### Current Landscape

The ware ship concept was used by the oil and gas industry in Alaska in the 1980s by Amoco during the drilling of several exploration wells in the Navarin Basin area of the Bering Sea.<sup>11</sup> The U.S. Navy has also used mobile multipurpose supply bases, also known as ware barges/ships/vessels. A ware vessel is a floating warehouse used to carry the consumables onsite for drilling and production operations. Ware barges

would be moved to the study area in the open water season and would be fully outfitted with all the equipment and spare parts needed for the majority of the operating season. They may also serve a secondary purpose of a flotel (floating hotel) providing either in-transit or extended-stay accommodation for operating crew or to facilitate crew change of support vessels and drill rigs, as well as an advance aviation base. A flotel is standard oil and gas industry approach for providing temporary quarters and could also be a stand-alone facility.

Additional points on port alternatives include the following:

- Ware barges/ships offer the ability to move the warehouse closer to offshore operations and to minimize unloading and reloading. Their utility increases as the distance from offshore operations to existing onshore alternatives increases. New ware ship concepts are available in the market place, with multiple proponents looking for a sponsor.
- Multipurpose ware vessels offer a potentially attractive option that permits the positioning of a supply base near the area of operations. This improves supply chain management by reducing the transit times and costs associated with personnel, material, and waste transfer. Multipurpose ware vessels are an alternative that the oil and gas industry can pursue and finance on its own and could be of value either in lieu of or in conjunction with a deep-draft port in closer proximity to the Alaskan North Slope; however, they may not be able to offer a year-round solution in heavy ice due to their size and potential special requirements (e.g., ice class).
- The “lighter aboard ship” (LASH) concept, which has been in use since the 1980s, is similar to the ware ship concept. Barges are preloaded with resupply equipment, which is subsequently “lightered aboard” (hoisted and stowed onboard) specially constructed ships, for transport to the offshore operations.<sup>12</sup> This concept, while once novel, has largely been replaced by heavy-lift ships.

### Prudent Development Context

Many of the same considerations listed in the previous section on maritime ports apply to port alternatives. Port alternatives have the advantage that they can be located to eliminate or minimize

<sup>b</sup> Even though Nome and Port Clarence are closer than Dutch Harbor, they are still a long distance away from the Beaufort and Chukchi Seas.

conflicts with other users. They are also inherently more scalable than permanent port facilities.

### **Future Aspirations and Options to Achieve**

Individual companies can be expected to make this investment as needed.

### **Navigation**

Safe navigation is important for all maritime vessel traffic that plies the Bering Strait and enters the study area. This includes maritime vessel traffic related to oil and gas activities and U.S. and non-U.S. related maritime traffic, including U.S. Coast Guard (USCG) and U.S. Navy (USN) vessels, cruise ships, scientific research vessels, commercial fishing vessels, commercial bulks carriers, and LNG tankers.

### **Current Landscape**

Maritime vessel traffic in the Arctic is increasing, as is the tonnage of cargo carried. Based on USCG reporting, vessel traffic increased by 118% in the Bering Strait from 2008 to 2012.<sup>13</sup> According to a USCG presentation at the 2013 Bering Strait Maritime Symposium Program, cargo carried in the period also increased from 100,000 tons in 2010 to 3,000,000 tons in 2012. This cargo, mainly iron ore, oil, and gas condensates, is expected to increase to 25,000,000 tons in 2017 and 50,000,000 tons by 2020.<sup>14</sup> A summary of the composition of maritime traffic through the Bering Strait for the period from October 30, 2013, to October 31, 2014, is shown in Figure 7-12. The increased maritime vessel traffic has heightened concerns over inadequate hydrographic data along the Alaska coast. This is a well-documented improvement area and activity is ongoing led by NOAA and the USCG to conduct bathymetric surveys that would allow nautical charts to be improved.<sup>15</sup>

### **Prudent Development Context**

Navigational aids are important for reducing the risk of maritime incidents. Improvements will benefit safe operations by all users of the Bering Strait.

### **Future Aspirations and Options to Achieve**

Navigational capabilities that will enhance navigational safety—thereby protecting people, physical assets, and the environment—are desired. This

will require investment in better navigational aids, enhanced hydrographic mapping, enhanced standards for vessels and crews plying the Bering Strait, and a significantly greater ability to respond effectively to maritime incidents, including ship groundings, spills, and medical emergencies. Enhancements in navigational aids and hydrographic mapping are considered below, while enhancements in the other areas are considered in the next section on maritime vessels and missions.

The following enhancements are desirable:

- A comprehensive, forward-looking evaluation of Bering Sea maritime traffic that identifies risks, deficiencies, and priorities. Such a foundational study would support funding requests for appropriate upgrades (e.g., navigation aids, improvements to the existing Automated Identification System, and expanded hydrographic mapping to improve nautical charts).
- Complete hydrographic mapping of the region, improve regional navigational and communication aids, and continue development of a comprehensive Arctic maritime traffic awareness system to improve monitoring and tracking of maritime activity.

## **MARITIME VESSELS AND MISSIONS**

This section considers maritime vessels with particular focus on oil and gas activity and operations. It considers alternatives to conventional maritime vessels including air cushion vehicles. Synergies between oil and gas industry requirements and missions for the U.S. Coast Guard and U.S. Navy are discussed in a later section of this chapter on U.S. armed forces synergies. A picture of an example icebreaker is shown in Figure 7-13.

Vessel duties (missions) for exploration include resupply, anchor handling, surface support for remotely operated vehicles and divers, ice management, oil spill response, and emergency evacuation. These duties are typically carried out by icebreakers or ice-capable support vessels. Additional duties for development include transport, construction, and installation and are carried out by highly specialized vessels.

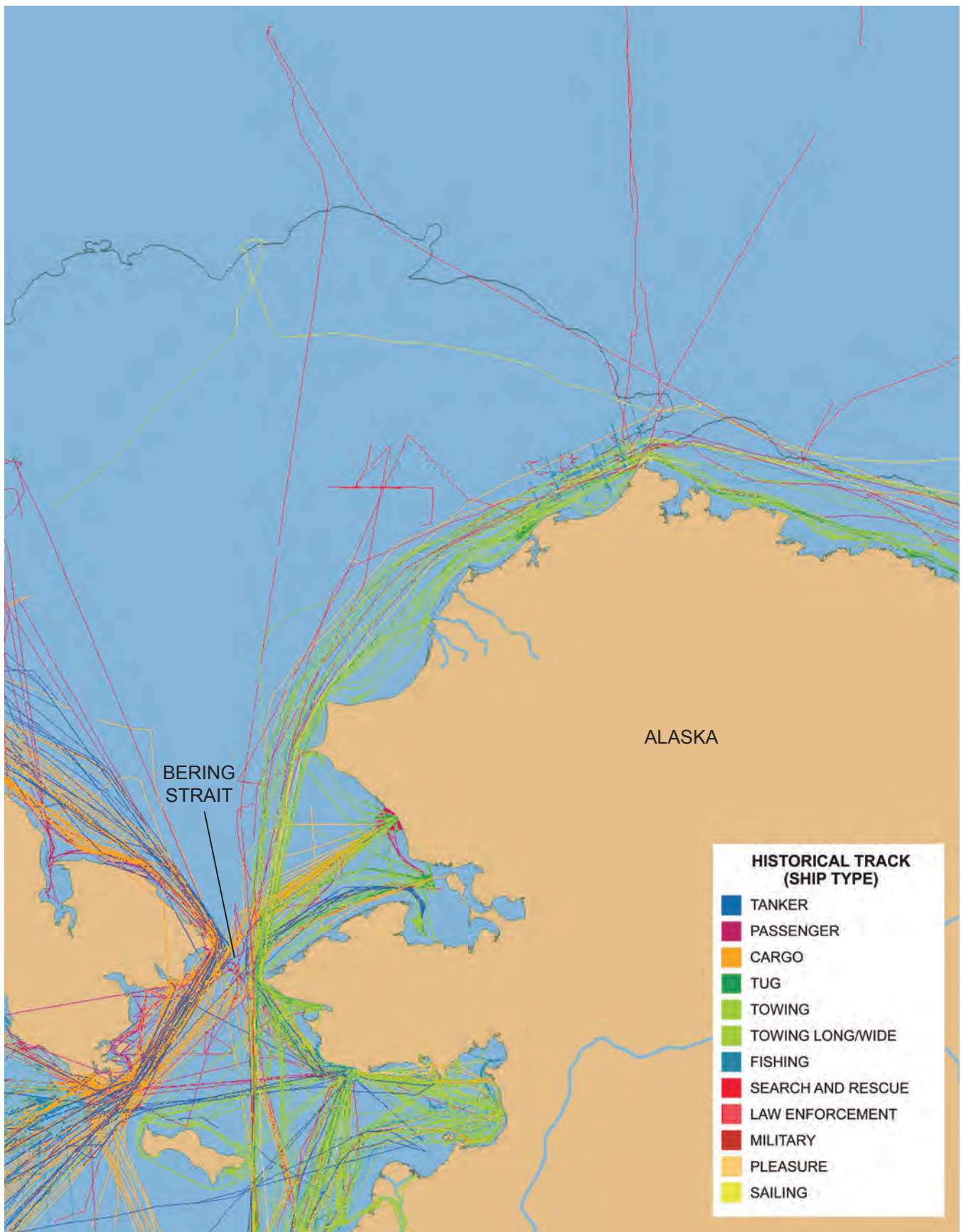

Note: Vessel tracking data were generated by the Marine Exchange of Alaska from their network of terrestrial AIS (automatic identification system) receiving stations in Alaska and data from exactEarth AIS satellite receivers.

**Figure 7-12.** Maritime Traffic Through the Bering Strait for Period October 30, 2013, to October 31, 2014



Photo: ExxonMobil.

**Figure 7-13.** Icebreaker Fennica

## Maritime Vessel Availability

### Current Landscape

The types of maritime vessels needed for Arctic oil and gas exploration (seismic survey vessels, drilling rigs, anchor handlers, icebreakers) exist today, but with limitations. These limitations include a very small global population of vessels that have the requisite ice class rating and an even smaller subset that also satisfy the requirements under the Jones Act for work in U.S. waters.

The global fleet of icebreakers is shown in Figure 7-14, from the USCG Office of Waterways and Ocean Policy. Vessels included “have sailed in significant sea ice in either the Arctic or the Antarctic,” have “ice strengthening sufficient for polar ice,” and possess “installed power of at least 10,000 horsepower.” Minimally ice-strengthened ships (enough to survive in ice, rather than operate in it) and icebreakers of less than 10,000 horsepower are not included. Not all icebreakers are suitable or available for Arctic offshore oil and gas activities. Most government icebreakers in Canada, the United States, Japan, Rus-

sia, Finland, and Sweden, etc., are not suitable for oil field duties due to design limitations; they are not designed for towing, at-sea cargo transfer to rig, anchor-handling, and ice management. A few vessels, notably in the Swedish and Finnish icebreaker fleets are operated in public-private arrangements, which have allowed these vessels to be used to support offshore activities in ice prone waters. Also of note, Finland has built a major share of the world’s icebreaking ships not only for their own account but also for Russia, Sweden, etc., and Finnish icebreaker technology has also been used in design and construction of such ships as the NSF’s *Nathaniel B. Palmer* and USCG’s *Healy*.

More detail on drilling rigs can be found in Chapters 1 and 6. Maritime vessels that are needed for a future offshore development (e.g., cutter suction dredgers) are in very small supply and are foreign-flagged and therefore not Jones Act compliant.

### Prudent Development Context

Maritime vessel design for operating in Arctic conditions is well established, as will be discussed in the

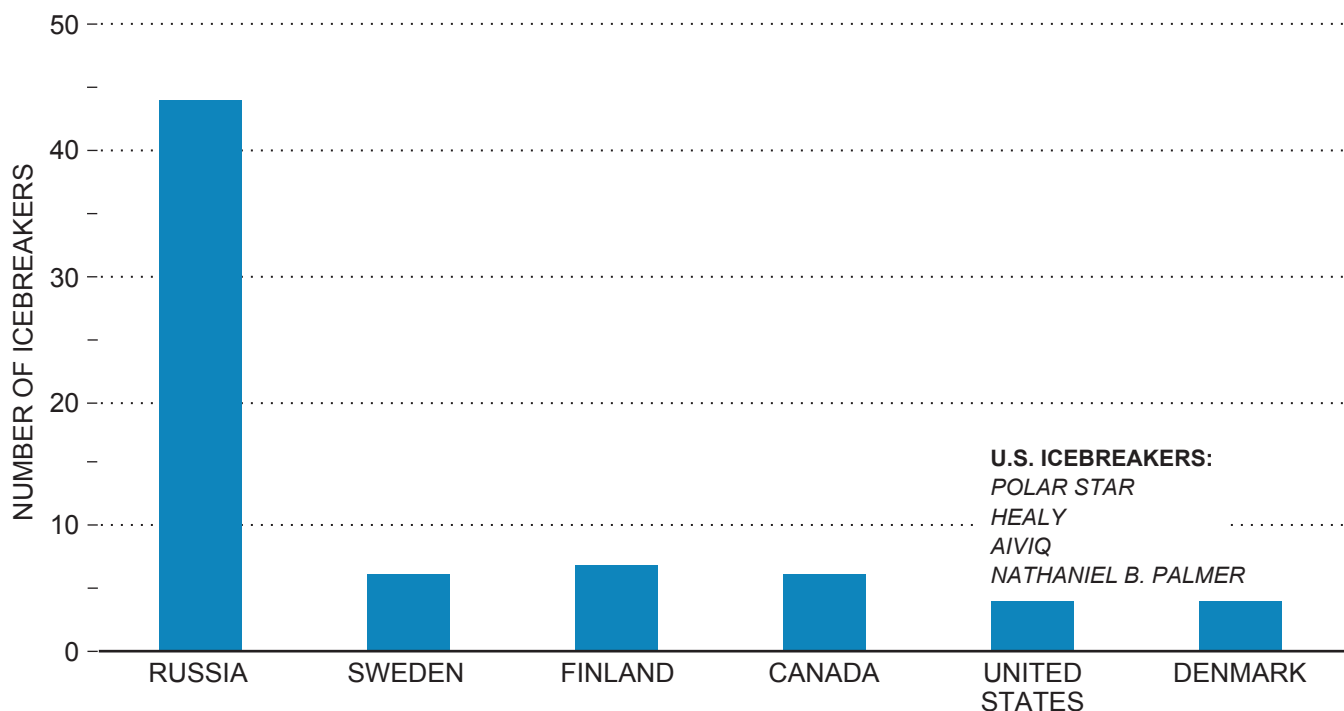

Source: USCG Office of Waterways and Ocean Policy, "Major Icebreakers of the World," <http://www.uscg.mil/hq/cg5/cg552/images/20140626%20Major%20Icebreaker%20Chart.pdf>.

**Figure 7-14.** *Worldwide Icebreaker Fleet Summary Including Vessels Available and Under Construction*

next section. The limited fleet of existing ice class vessels can impact exploration and development timing and economics.

### Future Aspirations and Options to Achieve

The availability of maritime vessels required for oil and gas exploration and development can be expected to increase based on speculative investment by vessel owners and contractors to meet a future market demand and by investment by individual oil and gas companies to accomplish specific activities.

## Ice Class and International Maritime Organization Polar Code

### Current Landscape

Design rules for ships that operate in ice have been in existence for more than 100 years and have undergone continuous improvement. The process is driven by a combination of experience, learning from incidents, and improved calculation methods. This experience and established practice forms the basis for the

classification society<sup>c</sup> rules in force today. While based on common experience, significant variance exists across classification society guidance. Furthermore, national regulations for ice class vessels vary from country to country. This broad variance in focus and requirement causes needless overlap and added complexity to vessel design, construction, and operation.

The Polar Code was developed to consolidate and provide common requirement baselines for polar shipping, with the intention of providing a clear international standard that signatory flag and coastal states would adopt into their national legislation. The Polar Code will continue to rely heavily on the classification societies for detailed polar class construction requirements. Accordingly, the International Association of Classification Societies (IACS) created detailed polar class construction requirements in 2008, which set out seven "different levels of ice class."

<sup>c</sup> A classification society is a nongovernmental organization that establishes and maintains technical standards for the construction and operation of ships and offshore structures. Classification societies include American Bureau of Shipping, DNV GL, Lloyd's Register, and Russian Maritime Register of Shipping.

The International Maritime Organization (IMO) adopted the safety part of the Polar Code in November 2014; and this provision will enter into force on January 1, 2017. The environment part of the Polar Code was approved by IMO in October 2014 and will be considered for adoption in May 2015. If the environmental provisions of the Polar Code are adopted at IMO, these provisions will also enter into force on January 1, 2017, thereby creating a unified Polar Code. In the near term, responsible operations in the Arctic will continue to rely on specific operations requirements governed by existing international conventions, national regulations, and industry best practices, as well as guidance in IMO Assembly Resolution A.1024(26) – guidelines for ships operating in polar waters adopted December 2, 2009.

Provisions of the Polar Code amend the International Convention for the Safety of Life at Sea (SOLAS) and the International Convention for the Prevention of Pollution from Ships (MARPOL). The safety-related provisions of the Polar Code apply to commercial cargo ships greater than 500 gross tons engaging in international voyages and passenger ships engaging in international voyages, when these ships are operated within polar waters as defined by the code. Amendments to MARPOL generally have a broader applicability for all ships engaging in international voyages, but the specific applicability of the environment-related provisions of the Polar Code will not be finalized until May 2015.

The safety-related provisions of the Polar Code will not apply to non-SOLAS ships or ships operating exclusively on domestic voyages, although member states are encouraged to apply the Polar Code or IMO guidelines as appropriate. Additionally, the Polar Code does not apply to ships owned or operated by a contracting government and is used, for the time being, only in government noncommercial service. However, these ships are encouraged to act in a manner consistent, so far as reasonable and practicable, with the Polar Code. Furthermore, the Polar Code provisions will not apply to drill rigs, given IMO's focus; however, drillships in transit would be expected to comply.

### **Prudent Development Context**

International conventions and design rules are required to promote safe and responsible maritime operations. Maritime casualties, including per-

sonal injuries, loss of life, spills, vessel damage, and sinking are unacceptable. The body of knowledge for safe practices includes the IMO requirements and ship classification society rules as discussed in the previous section as well as industry guidelines designed to codify best practices (e.g., those promulgated under the Oil Companies International Marine Forum), knowledge and experience from ship designers, and specific requirements of particular owners/operators.

### **Future Aspirations and Options to Achieve**

The United States should support implementation of the IMO Polar Code to ensure that maritime vessels transiting the Bering Strait and operating in U.S. Arctic waters meet the requirements of the Polar Code, including design, construction, equipment, operations, training, search and rescue, and environmental protection.

### **Merchant Marine Act of 1920 (Jones Act)**

Federal laws protecting shipping in the United States date back to 1789 and include the 1920 Jones Act governing the transportation of merchandise. The Jones Act requires that vessels transporting cargo between two U.S. points be built in the United States, crewed by U.S. citizens, and at least 75% owned by U.S. citizens.

### **Current Landscape**

Coastwise laws such as the Jones Act have evolved and expanded over the years, and sentiment to protect U.S. ship owners/operators, U.S. labor, and U.S. shipbuilding capacity remains strong in many areas. Any activities implicating the coastwise laws are closely scrutinized by the U.S. Customs and Border Protection, the Coast Guard, the domestic U.S. maritime industry, and Congress. As such, “the coastwise laws are highly protectionist ... and are intended to create a ‘coastwise monopoly’ in order to protect and develop the American merchant marine, shipbuilding, etc.”<sup>16</sup>

### **Prudent Development Context**

The United States has very limited domestic vessel capacity for ice management services and operations in ice conditions, which are an essential requirement

for Arctic exploration and development. Contracting these services to a foreign-flagged operator is an option. However, the Jones Act limits the ability to leverage the full mission support capability of these vessels (which are often capable of performing multiple functions). This forces the use of additional Jones Act compliant vessels to safely operate in the Arctic environment. Having oil and gas lease operators contract for purpose-built Jones Act vessels, and financing their construction through long-term charters is also an option, but is not necessarily considered reasonable or practicable due to the high-build and -operating costs of Jones Act vessels in comparison to those built in international shipbuilding countries.

The Jones Act has a significant impact on prudent development:

- **Mission Constraints:** The Jones Act restricts the ability for multi-mission, foreign-flagged vessels to operate within the full limits of their capabilities due to their inability to travel between two U.S. ports. Drilling rigs require constant consumables, waste, and personnel transfer. A foreign flagged icebreaker operating in close proximity to the drilling rig, although well capable of supporting these logistics operations, would be prevented by the Jones Act from carrying out any of these functions.
- Once exploration transitions to development, Jones Act restriction further limits the use of which vessels can be involved in undersea infrastructure missions such as dredging, trenching, and pipelaying. Dredging vessels, for instance, would need to be Jones Act compliant. If suitable vessels do not exist, then they would need to be built. The availability of yard space in the United States to build the number and type of vessels required is severely restricted and will likely result in delays to any project as well as cost overruns.
- The high cost to build and operate Jones Act vessels is well documented:
  - A 2013 study by the U.S. Department of Transportation Maritime Administration<sup>17</sup> estimates that operating costs for Jones Act compliant vessels and crews are substantially more than for foreign flagged vessels. Moreover, the observed capital costs to build Jones Act compliant ves-

sels are around three times the cost as compared to foreign vessels. Prudent Development must include these costs in the economics of business decisions.

- A recent study by the Congressional Research Service presents findings on the impact of the Jones Act requirements on shipping costs.<sup>18</sup> The study indicates that the purchase price of U.S.-built tankers is reportedly about four times the price of foreign-built tankers, and U.S. crewing costs are several times those of foreign-flag ships. The U.S. construction schedule is also considerably longer than foreign-built ships and shipyard capability is limited.
- “According to oil shippers, the price for moving crude oil from the Gulf Coast to the U.S. Northeast on Jones Act tankers is \$5 to \$6 per barrel, while moving it to eastern Canada on foreign-flag tankers is \$2.”<sup>19</sup>
- The financial implications of Jones Act compliance during exploration and appraisal operations are significant and limit the ability to fully leverage vessels capable of handling multiple tasks, such as icebreaking and resupply, resulting in the need to contract additional vessels to perform those duties thereby greatly increasing costs and risks, reducing flexibility, and potentially delaying projects.

There is currently no Jones Act-compliant heavy lift or dry-tow vessel. Therefore any nonpropelled vessels moving from a U.S. port to the study area must be wet-towed or delivered directly from a foreign port. Dry transport provides for greatly increased speed as well as decreased risk from storms due to the ability of the transport vessel to evade bad weather.

### **Future Aspirations and Options to Achieve**

Opportunities for enhancement include considering preapproval of specific Jones Act exemptions for vessels required for oil spill response, emergency evacuation, and rescue activities and for select specialty vessels required for development. This could be preceded by a government-led assessment, in consultation with the oil and gas industry, to identify the specific vessels and circumstances under which preapproval for exemptions might be possible.

## Maritime Vessel Alternatives

Logistical alternatives exist to address some of the constraints of maritime vessels with regards to ice and metocean conditions.

### Current Landscape

Maritime vessel alternatives include hovercraft and airships (lighter than air). In most cases, these technologies exist today; however, some level of adaptation or demonstration is required. Additionally, operational constraints of the alternatives have delayed implementation to date.

### Prudent Development Context

Any vessel alternatives need to be safe and environmentally responsible and appropriately designed.

### Future Aspirations and Options to Achieve

There are, at least, niche commercial or government markets for hovercraft, and there does not appear to be compelling argument for an expanded government role. Further development of hovercraft can be done by the technology providers, either on a speculative basis or in conjunction with an operator's specific plans. Airships are addressed in the next section.

## AVIATION INFRASTRUCTURE AND AIRCRAFT

Aviation is a critical transportation mode for Alaska, given the distances, scarcity of roads and rail connecting onshore infrastructure, and the offshore nature of the study area. Aviation is important for the movement of goods and people and for search and rescue and emergency response, serving both local populations and industry. For the oil and gas industry, aviation routinely supports surveillance and reconnaissance for baseline science data gathering, ice characterization studies, and marine mammal monitoring during operations. Aviation is also key for resupplying and for the transferring of personnel to remote locations, including maritime offshore assets. Emergency response duties include medevac, search and rescue, and support of oil spill response.

Search and rescue, which draws heavily on aviation infrastructure and aircraft, is covered in the section on U.S. Armed Forces synergies as part of a discussion of the U.S. Coast Guard mission.

## Aviation Infrastructure

### Current Landscape

Air operations in the remote regions of Alaska are challenging due to weather conditions and the lack of suitably equipped airfields. Suitably equipped airfields are defined as those with hangars, Jet-A fuel, suitable aircraft rescue and fire fighting response capabilities, Instrument Flight Rules (IFR) ground-based approaches, runway lighting, and ground de-icing capability. Aviation is also constrained by the general lack of logistics and infrastructure support—fuel supplies, maintenance services, communications, etc. A further constraint is the lack of developed airspace (i.e., air space with radar coverage to provide IFR separation and communications and weather reporting capabilities).

A broad range of manned fixed-wing aircraft and helicopters are active in Alaska. Unmanned aircraft are also being introduced, subject to FAA restrictions to ensure flight safety and avoid collisions. Unmanned aircraft are particularly well suited to surveillance and reconnaissance missions, including monitoring of marine mammals.

### Prudent Development Context

Safe and reliable aviation transportation is important to the oil and gas industry and to remote communities. New airfields, enhancements to existing airfields, and airspace development will benefit industry and local communities through more reliable and available air service.

While there are significant challenges for Arctic aviation, there are existing controls that have been established by the FAA, oil and gas industry guidelines, and operator specific safety requirements. Together, these controls have created a very strong safety record for oil and gas aviation operations in Alaska. There are also ongoing initiatives by the FAA to improve airspace development, including IFR separation, communications, and weather reporting to increase safety while increasing the availability of safe flying conditions.

The oil and gas industry through the International Association of Oil & Gas Producers, a trade association for the global upstream industry, have safe flying guidelines that augment requirements set by the FAA. These include:

- *Air transportation – Recommended practices for air operations*, Report No: 410, June 2008
- *Aircraft management guidelines*, Report No. 390, July 2008, updated August 2013

The development of new airfields and enhancements to existing airfields, whether done expressly to support industry or for broader purposes, will need to be done in coordination with federal, state, and local communities. Development and air routes will have to be sensitive to communities' needs and concerns. Mutual development may offer benefits to all parties. Repurposing existing or abandoned facilities located away from existing communities may, in some cases, be an optimal solution.

Following are examples of repurposing opportunities that may assist in future exploration and development operations in the Arctic, but each has limitations. In each example, sites effectively segregate industry activities from culturally sensitive population centers while offering existing military hard infrastructure (ports/runways) for development. Examples include:

- The former naval air station in Adak, Alaska, in the Aleutian Islands could be a viable maritime and aviation support base for future exploration and development operations. This could be a possible joint venture (private/private, public/private) opportunity to position for the future.
- The former USCG Loran C station in Port Clarence could provide an opportunity to serve as a maritime and aviation support base during the operational season. Port Clarence is situated approximately 100 nm southeast of the Bering Strait.
- The former Distant Early Warning Line site approximately 5 miles south of the city of Wainwright, Alaska, and 70 miles west of Barrow, Alaska, could provide an opportunity to move both maritime and aviation support activities within 75 miles of the Chukchi exploration and development operations.

## Future Aspirations and Options to Achieve

As operations in the region expand, shared services and shared costs, both across the oil and gas industry as well as federal, state, and local governments and other commercial entities, can lead to the development of more robust facilities and support services. The following recommendations would help achieve significant improvements in the safety and reliability of aviation in the region to support development and local communities:

- Industry, local, state, and federal government agencies should coordinate infrastructure planning by performing where possible joint scenario planning to identify mutual needs.
- Government should consider developing solutions for airspace management and traffic deconfliction that accommodate helicopter, fixed-wing, and unmanned aircraft operations (typically referred to as unmanned aerial vehicle or unmanned aerial systems).
- Continued development of regulations by the FAA to allow unmanned aircraft to support pipeline surveillance, search and rescue, oil spill response, etc. This should include controlled flight of unmanned aircraft beyond line of sight.
- Increased support for ongoing initiatives by the FAA to improve airspace development (IFR separation, communications, weather reporting), including the Automated Weather Observation System and the Remote Communications Air/Ground communication system. The objective is to increase safety while increasing the availability of safe flying conditions.

## Aircraft

### Current Landscape

Numerous fixed and rotating wing aircraft can operate safely in Arctic conditions. Key considerations that impact equipment selection and operational availability are minimum operating temperatures, icing, and ability to operate from unimproved airfields. Specific considerations include:

- Minimum operating temperatures vary by aircraft type, but are normally down to -32°F to -40°F. Aircraft cannot be operated in conditions below their certification limit.

- No aircraft can operate in severe icing conditions even with de-ice systems.
- The type of runway surface limits the type and size of aircraft that can land and be supported.

### **Prudent Development Context**

Aircraft safety is governed by the aircraft's FAA certification.

### **Future Aspirations and Options to Achieve**

An opportunity for enhancement is joint industry and government evaluation of the usefulness of new unconventional airframes in the Arctic regions. This includes airships to ferry material and possibly crews to the area of operations. Airships are an emerging technology that offset some of the logistical challenges of the Arctic, such as the lack of deepwater ports and environmental and weather constraints. Several designs from multiple aerospace companies are being explored and considered.

## **COMMUNICATIONS INFRASTRUCTURE**

### **Current Landscape**

Voice and data telecommunications are important for coordination of integrated operations and transfer of safety critical data. Examples of the latter include transfer of radar imagery and ice charts to maritime vessels and transfer of real-time drilling data to shore-based monitoring facilities. Increasingly, communications and bandwidth are also important for crew morale (e.g., allowing streaming of movies, video gaming, and voice over Internet communications with remote family members and friends).

Telecommunications as they exist today are sufficient to support coordination of integrated operations and transfer of safety critical data, but not much more.

The telecommunications industry has strived to provide ubiquitous services wherever it is economically attractive to do so. Its efforts have been so successful that the availability of some form of wireless phone/data service with reasonable speed and bandwidth is now a normal expectation in many regions of the United States, including parts of southern Alaska. However, this is not the case on the North Slope of Alaska.

There are three primary telecommunications transport methods being utilized in northern Alaska:

- **Satellite:** The primary means of communication to the outside world for the communities of the Arctic and the study area, with the exception of the Prudhoe Bay operating area and its associated pipeline corridor.
- **Point-to-Point Radio (Microwave):** Supports the extension of the footprint of services from the satellite earth station/fiber optic facilities to areas requiring telecommunication services.
- **Fiber Optic Connectivity:** Currently this method is available via the TAPS pipeline corridor and supports the Prudhoe Bay operating areas with much greater capacities (bandwidths) and speed than are widely available to satisfy the increasing technological demands for telecommunication services.

These telecommunications methods and their associated facilities/infrastructure make up the backbone of the connections to the main communication centers in Alaska and the rest of the United States.

Telecommunication technology selection and investment decisions are dependent on many criteria: economics, time (duration of the telecom requirements), availability of infrastructure (power utilities) and transport methods (road, maritime, aircraft) for accessing the area, and associated permitting and environmental concerns. There is, at present, little economic incentive for the telecommunications industry to make additional investments on the North Slope due to its small population and host of development challenges.

### **Prudent Development Context**

Communication networks are important to the oil and gas industry as well as remote communities for staying connected to the larger outside world and bridging the remoteness. Of particular importance are bandwidth and reliability. Additional network capacity will benefit industry and local communities.

### **Future Aspirations and Options to Achieve**

Greater availability of affordable voice and data communications services with greater bandwidth

and speed would better link communities and businesses, providing them with capabilities that are more comparable to those that are readily available in most of the United States. It would also support oil and gas development by providing increased bandwidth.

Electrical power and transportation/access corridors are key requirements for developing improved communications infrastructure. Therefore, as government and industry plan and develop infrastructure, communications should be a key consideration. Roads, pipelines, and remote installations may offer synergies for the development of communications infrastructure. The following recommendations will help improve affordable and reliable telecommunications in remote Alaska regions.

- Industry, local, state, and government agencies should consider coordinating infrastructure planning by carrying out where possible joint scenario planning to identify mutual needs. This could include a strategic telecommunications development plan that incorporates potential opportunities provided by new development projects.
- Monitor and pursue opportunities that may be afforded by foreign interests proposing to lay fiber optic cables on the sea floor near Alaska. These include cables between Tokyo and London as well as a cable along the Russian coast.
- Government should provide approved rights-of-way for telecommunications land facilities and supporting infrastructure, as well as promoting investments in such facilities.
- Government should provide for research and development of improved telecommunications methods and equipment that addresses the challenges of the Arctic.

## REMOTE SENSING INFRASTRUCTURE

The oil and gas industry currently requires synthetic aperture radar (SAR) data from SAR-equipped satellites to satisfy its ice management needs.

### Current Landscape

SAR information is presently obtained through satellite uplink facilities such as that operated by the

University of Fairbanks shown in Figure 7-15. SAR information is essential to effective ice management. The workhorse SAR satellite today is the Canadian Radarsat 2 satellite.

The need for timely, high-quality information on sea ice is shared by the oil and gas industry for its operations, the U.S. Coast Guard for search and rescue operations, all parties engaged in offshore and oil spill response activities, and all parties engaged in maritime activities in the area.



Photo: University of Alaska Fairbanks.

**Figure 7-15.** *The Newest Addition to the Alaska Satellite Facility Ground Station, a 7.3-meter Antenna (Part of the Geophysical Institute at the University of Alaska Fairbanks, it started receiving data in the fall of 2014 and it downlinks, processes, archives, and distributes remote-sensing data to scientific users around the world.)*

Although the present capabilities are adequate for current purposes, several limitations should be considered:

- There is no U.S. government-owned or U.S. satellite that can provide the SAR information needed to manage ice for oil and gas exploration and development purposes.
- Consequently, the oil and gas industry relies on non-U.S. assets for SAR services/data.
- Although this is probably adequate for most of the oil and gas industry's purposes, it is not an ideal arrangement when timely data are needed for search and rescue, oil spill response, or other emergencies.
- Reliance on private, non-U.S. satellites results in there being a numerous restrictions on the use and dissemination of data.
  - The University of Alaska, for example, receives SAR data and provides it to its sponsors.
  - It has a mixed bag of funding sources, and it is not free to provide data to those who are not paying for it.
  - This is not conducive to sharing of information for research purposes.
  - Data acquisition costs can be a substantial barrier to researchers.
- A central repository of SAR ice data would be helpful.

## Prudent Development Context

Synthetic aperture radar information is essential to effective ice management.

## Future Aspirations and Options to Achieve

NOAA should maintain at least the current capability of polar observing weather satellites and evaluate the merits of a new publicly accessible synthetic aperture radar satellite.

A collaborative approach that coordinates the needs and requirements of stakeholders requiring SAR information could help to secure multiple sponsors/funding sources. Even without oil and gas industry participation, potential sponsors include NOAA, the U.S. Coast Guard, and the Department of Defense.

The oil and gas industry, as well as other Alaskan commercial enterprises, would benefit from the information from such a satellite.

## U.S. ARMED FORCES SYNERGIES

There are strong synergies between the missions of the U.S. Armed Forces, particularly the USCG and USN, and infrastructure requirements to support prudent oil and gas exploration, development, and ultimately development in the study area. These agencies are subject to the same frontier infrastructure, resupply, and support constraints in the Arctic as the oil and gas industry, as illustrated in other parts of this chapter. Additionally, the USCG has a strong role in supporting oil and gas exploration and development in the areas of safety and security.

## U.S. Coast Guard

Among its missions, including the humanitarian one of saving lives at sea for which it is most noted, the Coast Guard is also charged with enforcing laws and treaties and protecting sovereignty in waters over which the United States has jurisdiction. Of equal importance, the Coast Guard also has enforcement powers on behalf of other federal agencies on the high seas if those agencies are absent.<sup>20</sup>

With respect to its humanitarian mission, the USCG is the federal agency responsible for maritime search and rescue operations. Search and rescue is the search for and provision of aid to people who are in distress or imminent danger. This role is legislated in the National Search and Rescue Plan. By way of completeness, the United States Air Force is the federal agency responsible for inland search and rescue. Both agencies maintain rescue coordination centers to coordinate this effort and have responsibility for both military and civilian search and rescue.

With respect to its maritime environmental protection mission, the USCG is the federal agency responsible for overseeing planning, preparedness, and response to oil and hazardous substance pollution incidents in the coastal zone. This role is legislated in the National Oil and Hazardous Substances Pollution Contingency Plan (NCP) (40 CFR 300). The U.S. Environmental Protection Agency is the federal agency responsible for the inland zone.

## Current Landscape

The USCG has only two Arctic-capable icebreakers—*Healy* (built in 1999) and *Polar Star* (built in 1976). Operating past her design service life, *Polar Star* is kept operational by commandeering critical spare parts from the now inactive sister ship *Polar Sea*. Despite a long history of independent Arctic operations, the Coast Guard has recently redoubled its efforts to understand the requirements of the more integrated operation the expanding Arctic will require. Therefore, the USCG initiated Arctic Shield in 2012 and has continued the exercise in 2013 and 2014. Arctic Shield focuses on operations, outreach, and an assessment of capabilities with a specific focus on how to meet traditional maritime enforcement, security, and humanitarian missions by modifying or acquiring special-purpose equipment. Arctic Shield's elements consist of:<sup>21</sup>

- Operations: integrated operations with multiple cutters, aircraft, and personnel deployed throughout the region
- Outreach: includes learning from and sharing with Alaskan Native partners
- Capability assessment: involves an analysis of frontline operations and mission support requirements in an expanded Arctic theater.

The capability assessment is intended to identify shortcomings in traditional assets when applied to the Arctic environment and to help identify specific skill sets required for operations personnel (i.e., the skill sets that are now most often found in experienced icebreaker crews). The results obtained will inform future decision-making, legislative rulemaking, and operating procedures.

Because of the lack of ports from which to refuel, Coast Guard missions are essentially limited to the amount of fuel carried onboard. When a ship runs low on fuel, it must either be replaced with a second ship, which becomes expensive and resource intensive, or the mission is suspended until fuel can be resupplied, which is inefficient and creates a risk to mission fulfillment.

## Prudent Development Context

The USCG plays an important role in the areas of security and safety. Meeting this role requires:

- High-latitude bases from which to operate

- Keeping pace with both the oil and gas industry and the rate of change in Arctic operations.

The needs associated with high-latitude bases are similar to the oil and gas industry requirements described in the maritime port infrastructure and navigation section earlier in this chapter.

## Future Aspirations and Options to Achieve

The future aspiration is to have a vibrant USCG presence and partnership. Toward this end, the following enhancement opportunities are seen, many of which are already ongoing:

- Continue longstanding partnership with the oil and gas industry (e.g., oil spill response)
- Partner with industry and others in infrastructure planning
- Continue Arctic Shield while considering opportunities to step up scope and objectives
- Continue the long history of cross-border incident management and response by the U.S. and Canadian federal governments.

## U.S. Navy

The Navy, as the maritime component of the Department of Defense, has global leadership responsibilities to provide ready forces for current operations and contingency response in Arctic Ocean environments. The Navy's functions in the Arctic region are no different from those in other maritime regions; however, it is recognized that the Arctic region environment makes the execution of many of these functions much more challenging.

The Navy is charged within the Department of Defense as the lead maritime agency to protect the national security. As discussed elsewhere, historically, both the Coast Guard and Navy have been able to fulfill this responsibility in the limited-use Arctic environment. However, as Arctic use, maritime traffic, and jurisdictional incursions are made, both the Coast Guard's and the Navy's ability to effectively meet mission requirements will be challenged by their existing fleet and infrastructure. Because the Navy faces the same logistics limitations (inadequate port infrastructure and long supply lines) as does the oil and gas industry, a collaborative approach to addressing these limitations is of benefit.

## Current Landscape

The Navy has no ice-capable surface combat ships, having turned its last icebreaker over to the Coast Guard in 1966. On the other hand, given the Navy's warfighting mission of force projection, it does possess a sophisticated fleet support and refueling capability.

The U.S. Navy Arctic Roadmap (February 2014) provides direction to naval commanders, placing particular emphasis on near-term actions necessary to enhance the Navy's operational capabilities. In the near-term, the Navy will refine doctrine, operating procedures, and tactics, techniques, and procedures to guide future potential operations in this region. In the mid-term, the Navy will provide support to the combatant commanders, Coast Guard, and other U.S. government agencies. The Navy will continue to develop and enhance cooperative relationships across the Department of Defense and with U.S. government agencies, industry, and international allies and partners.

Naval security and international naval cooperation have always been critical components of U.S. Arctic policy. As the Arctic Ocean opens, these components will increase as activity rises. The Navy Arctic Roadmap underscores the need to develop strong cooperative partnerships with industry, interagency, and international Arctic region stakeholders. It acknowledges the role climate change plays in energy security, research and science, the economy, fisheries, tourism, the assertion of sovereignty, and other related issues. The Navy will take deliberate steps to anticipate and prepare for Arctic region operations and address emerging challenges caused by the opening of the Arctic Ocean waters.

## Prudent Development Context

The Navy is responsible for national defense.

## Future Aspirations and Options to Achieve

Considering the Navy Arctic Roadmap, areas that warrant further discussion and coordination include but are not limited to:

- **Environmental Sensor Strategy:** Accurately characterizing and modeling the Arctic's dynamic maritime and terrestrial environments.

- **Basing:** The movement of resources through the air or on the sea across great distances by naval forces trained and equipped to support other U.S. government agencies in the Arctic region may be required.
- **Search and Rescue Coordination with U.S. Coast Guard and Royal Canadian Navy:** Acknowledging the distinctive missions, competencies, and cultures of U.S. sea services, the Coast Guard and Navy will remain ready to support critical missions.

The Navy should also consider additional investment in Arctic-capable ships.

## ALASKAN NATIVE SYNERGIES

### Current Landscape

Oil and gas exploration and development in northern Alaska has created opportunities that have benefited the local communities, the state, and industry. By better understanding the development climate and the regulatory processes, a more streamlined approach has facilitated the growth of local village and regional corporations while ushering in major oil and gas development. Examples of successful cooperation between the oil and gas industry and Alaskan Natives include:

- Projects like Northstar that provided the genesis for today's Conflict Avoidance Agreement. This agreement is a tool created by the Alaska Eskimo Whaling Commission to coordinate indigenous whaling activities and offshore oil and gas activities, which is governed by the North Slope Borough land use ordinance Title 19.
- The ConocoPhillips Meltwater Project, where construction and some operations were curtailed or stopped during and after the calving period, pipelines were raised to a minimum of 7 feet above the tundra, and traffic was limited and convoyed during the calving season to protect caribou migration and accessibility for subsistence activities.
- Alpine Satellite Development Project, in the heart of the Nuiqsut area of influence, on surface Kuuk-pik lands, created the North Slope Borough Mitigation Fund Advisory Committee; it is annually funded by the industry to mitigate subsistence activities in otherwise village hunting lands.
- The development of offshore manmade islands like Oooguruk and Spy Islands in collaboration with

the local government, which minimized the risk of an offshore oil spill by developing inside tanks that could pump spilled oil down the subsea pipeline as the first line of defense to prevent oil from entering the Beaufort Sea.

Putting people together (industry and local corporations) has proven to be a successful path to all parties working together to achieve a balance acceptable to all parties. And finally, the North Slope Borough developed the NPR-A technical report with recommendations to facilitate cooperation between the federal government, the state of Alaska, industry, and the North Slope Borough to help identify issues and potential policies for the continued oil and gas expansion that have implications borough-wide. Perhaps, just as the “2007 Oil & Gas Forum” brought entities together, a follow-up oil and gas forum would bring folks back to review the NPR-A technical report and facilitate cooperative agreements and potential Title 19 revisions.

The success of engagement opportunities as described above are examples of how important it is to blend the positive impacts that Western science and international operating experience affords through industry exploration and development with the environmental considerations and the traditional knowledge possessed by the Alaskan Native population developed over a millennium of experience. When carefully balanced and considered, the outcome is always more positive than an uninformed approach. This proven teaming can achieve the desired outcomes in a manner that supports all parties involved and contributes to the highest degree possible to the growth of the communities while protecting the rich cultural values that the residents possess.

## Prudent Development Context

Prudent development can only proceed in partnership with local communities.

## Future Aspirations and Options to Achieve

Some considerations to enable prudent development that can only proceed in partnership with local communities include:

- Individual companies need to show a willingness to understand and be sensitive as communities may

have to adapt—empower communities by being open.

- The North Slope Borough has zoning and land use powers—engage directly and be open. The North Slope Borough has worked directly on behalf of the communities to balance development. The North Slope Borough has important information on infrastructure and erosion issues, and has concerns over the 500,000 caribou that come to calve in the North Slope, which is an important subsistence resource. Work with communities on every level to gain a thorough understanding.
- Periodically meet with the North Slope Borough, Northwest Arctic Borough, the trilateral committees of the communities affected, the regional tribal entity, and the Iñupiat Community of the Arctic Slope to forge lasting and positive relationships.
- Involve communities in future planning projects. Communities may have ideas that could maximize potential uses along with industry and, where potential pipeline corridors could be planned, that could minimize impacts to subsistence activities and the large-scale movements of terrestrial mammals.

## REFERENCES

- 1 Interagency Working Group on Coordination of Domestic Energy Development and Permitting in Alaska, *Managing for the Future in a Rapidly Changing Arctic: A Report to the President*, March 2013, <http://www.doi.gov/news/upload/ArcticReport-03April2013PMsm.pdf>.
- 2 Kevin Hillmer-Pegram, *A Synthesis of Existing, Planned, and Proposed Infrastructure and Operations Supporting Oil and Gas Activities and Commercial Transportation in Arctic Alaska*, University of Alaska Fairbanks, 2014.
- 3 Chris Castellano-Alaska Aviation Weather Unit, “MVFR/IFR Climatology for Selected Alaska TAF Sites,” [http://aawu.arh.noaa.gov/misc/papers/MVFR\\_IFR\\_Climatology\\_Report.pdf](http://aawu.arh.noaa.gov/misc/papers/MVFR_IFR_Climatology_Report.pdf).
- 4 Jonathan V. Hall, et al., *Status of Alaska Wetlands*, 1994, U.S. Fish and Wildlife, Alaska Region, Anchorage, Alaska, <http://www.fws.gov/wetlands/Documents/Status-of-Alaska-Wetlands.pdf>.
- 5 U.S. Department of the Interior, Bureau of Land Management, “National Petroleum Reserve-Alaska Integrated Activity Plan/Environmental Impact Statement,” DOI-BLM-AK-0000-2010-0001-EIS, <https://www.blm.gov/epl-front-office/eplanning/planAndProjectSite.do?methodName=dispatchToPatternPage&currentPageId=14702>.
- 6 *Analysis of Commercial Marine Vessels Emissions and Fuel Consumption Data*, Office of Transportation and Air Quality U.S. Environmental Protection Agency, EPA420-R-00-002, February 2000.
- 7 Mead and Hunt, Inc., *Alaska Roads Historic Overview: Applied Historic Context of Alaska’s Roads*, prepared for Alaska Department of Transportation and Public Facilities, February 2014, <http://dnr.alaska.gov/parks/oha/publications/akroadshistoricoverview.pdf>.

- 8 S. K. Lewis, *Long-Range Planning Assures Success of Bering Sea Drilling*, ARCO Alaska, Inc., IADC/SPE 11370, 1983, IADC/SPE 1983 Drilling Conference.
  - 9 U.S. Army Corps of Engineers, *Alaska Deep-Draft Arctic Port System Study*, March 2013, <http://www.poa.usace.army.mil/Portals/34/docs/AKports/1ADDAPSReportweb.pdf>.
  - 10 IMV Projects Atlantic Inc., *Arctic Offshore Technology Assessment of Exploration and Production Options for Cold Regions of the US Outer Continental Shelf*, prepared for U.S. Department of the Interior, Minerals Management Service, IMVPA Project No. C-0506-15, January 2008, [http://www.bsee.gov/uploadedFiles/BSEE/Technology\\_and\\_Research/Technology\\_Assessment\\_Programs/Reports/500-599/584AA.pdf](http://www.bsee.gov/uploadedFiles/BSEE/Technology_and_Research/Technology_Assessment_Programs/Reports/500-599/584AA.pdf).
  - 11 Millheim, K.K., Boykin, G.F., Zaremba, H.B., *Case History: Designing and Implementing the Operations for Drilling in the Navarin Basin, Alaskan Bering Sea*, IADC/SPE Drilling Conference, Dallas, Amoco Production Co., reprint No. IADC/SPE-14732, February 10-12, 1986.
  - 12 James J. Buckley and Lane C. Kendall, *The Business of Shipping*, 7th edition, Cornell Maritime Press, Centerville, MD, 2001, pp 11 and 372.
  - 13 United States Coast Guard, *Arctic Strategy*, May 2013, p 5, [http://www.uscg.mil/seniorleadership/docs/cg\\_arctic\\_strategy.pdf](http://www.uscg.mil/seniorleadership/docs/cg_arctic_strategy.pdf).
  - 14 U.S. Coast Guard Seventeenth District Nome Maritime Symposium, February 2013, <https://seagrant.uaf.edu/conferences/2013/bering-strait-maritime/presentations/houck-cg-overview-traffic-spill-response-web.pdf>.
  - 15 Ashley Chappell, "NOAA and Coast Guard work together to get more surveying done in the Arctic," NOAA Coast Survey blog, <https://noaacoastsurvey.wordpress.com/2013/11/21/noaa-and-coast-guard-work-together-on-arctic-surveys/>.
  - 16 U.S. Customs and Border Protection, CBP Headquarters Ruling (HQ) 116630 (March 27, 2006), Re: Coastwise Transportation.
  - 17 U.S. Department of Transportation Maritime Administration, [http://www.marad.dot.gov/library\\_landing\\_page/maritime\\_publications/Library\\_Publications.htm](http://www.marad.dot.gov/library_landing_page/maritime_publications/Library_Publications.htm).
  - 18 John Frittelli, *Shipping U.S. Crude Oil by Water: Vessel Flag Requirements and Safety Issues*, Congressional Research Service, July 2014.
  - 19 Ibid.
  - 20 Title 14 United States Code, Part 89 – Law Enforcement.
  - 21 U.S. Department of Homeland Security News, "Written testimony of U.S. Coast Guard Commander – Seventeenth District, Rear Admiral Thomas Ostebo for a Senate Committee on Commerce, Science, and Transportation, Subcommittee on Oceans, Atmosphere, Fisheries, and Coast Guard field hearing on U.S. Coast Guard operations in the Arctic," October 11, 2012, <http://www.dhs.gov/news/2012/10/11/written-testimony-us-coast-guard-senate-commerce-science-and-transportation>.
-

# Chapter 8

## Arctic Offshore Oil Spill Prevention, Control, and Response

### INTRODUCTION

**O**il spill response in the Arctic is a critical issue to all concerned stakeholders: residents, operators, regulators, and the general public. Concerns regarding industry's capacity and capability to deal with spills in Arctic waters, especially in the presence of ice, are in the forefront of any discussion about future offshore drilling plans in the Chukchi and Beaufort Sea regions. Developing enhanced oil spill response (OSR) systems and building confidence in their capabilities are essential elements in the acceptance of future drilling activities and eventual extension of those activities into the ice season. Prevention of well control incidents and oil spills are the priority of industry when planning any operation, and the emphasis on prevention must always be considered with any project.

To appreciate the technology achievements to date and to determine future technology needs surrounding the issue of oil spill response and prudent development, this introduction to the chapter stresses a number of key areas:

- The long history of safe and successful Arctic offshore exploration and development
- The role of prevention as the primary defense against loss of well control
- The long history of research into oil behavior and response in ice
- The value of collaboration in further advancing Arctic OSR capabilities
- The need to understand various trade-offs in selecting the most effective OSR strategy.

### History

Exploration drilling operations in Arctic conditions began at Norman Wells in the Canadian Northwest Territories in 1920 and production began in 1932.<sup>1</sup> This field continues to produce with a long record of integrity in spite of challenges such as seasonal flooding, ice jams, ice scouring, and permafrost.

The Prudhoe Bay field on the Alaskan North Slope began producing in 1977. Specialized construction practices and engineering design led to drilling through permafrost and operating production facilities under extreme climatic conditions. The first offshore Alaska Beaufort Sea production occurred in 1987 at the Endicott field using gravel production islands. No loss of containment has occurred from these wells during more than 25 years of production. Farther south but still in Alaska, the Cook Inlet oil platforms continue to produce oil in challenging dynamic seasonal ice conditions and extreme tides, with a 50-year record of no major spill incidents (first platform installed by Shell in 1964).

Hundreds of wells have been drilled in offshore Arctic (or Arctic-like) drilling programs in Canada, Norway, Greenland, and the United States.<sup>2</sup> Almost 40 of these wells were drilled from artificially thickened floating ice platforms in water depths up to 550 meters (1,800 ft.). Numerous shallow-water exploration wells were drilled in the U.S. and Canadian Beaufort Sea starting in 1970.<sup>3</sup> All of these wells were drilled without loss of containment from the reservoirs.

### The Bowtie Depiction of Risk Management: Prevention to Response

The primary method to guard against a hydrocarbon spill is prevention. This is achieved through

adherence to established codes/standards and operations integrity management systems, combined with a culture of safety and risk management. Industry's primary approach to prevention centers on guarding against loss of well control through design with at least two barriers in place for any possible hazard; industry has more than two barriers in most cases. The three different levels of prevention are shown schematically in the "bow tie" Figure 8-1. The left hand side of the bow tie depicts proven controls and barriers designed to prevent incidents that could escalate and lead to a loss of well control. Combinations of these barriers are employed in the well design. The greatest benefits in terms of reducing environmental risks are to be found in the primary and secondary phases of prevention—that is, in preventing any loss of control in the first instance.

The controls and barriers included are:

- Adequate subsurface information (seismic, faults, geology, etc.), which can be used for selecting the well location, well design, required casing program, identify shallow hazards, etc.
- Selection of an appropriate drilling rig
- Proper well design, which includes the mud utilized, casing design, rate of penetration, cement used, and procedures for cementing, etc.
- Technical staff involved in properly designing the well, overseeing and monitoring the drilling operations, and using remote monitoring centers (when appropriate) to monitor rig activities
- Blowout preventer (BOP) that is fit for the expected well conditions, properly maintained, and tested in compliance with the regulations
- Continuous monitoring of weather and ice conditions at and near the site so that operations can be planned properly and if the need arises, they can be curtailed if ice conditions may impact the drilling rig or other activity.

In the unlikely event that a loss of well control incident takes place, then the response and recovery measures come into play:

- A capping stack is mobilized and installed on the well to provide a quick response to stop the flow of the well.
- In addition to the quick mobilization of the capping stack, the OSR equipment that has been

detailed in the oil spill response plan approved by Bureau of Safety and Environmental Enforcement (BSEE) is activated immediately. This includes mechanical recovery equipment like skimmers and booms, dispersant application equipment (air, vessel, and subsea), in-situ burning, storage capacity for recovered oil, monitoring and detection equipment, personnel, and other resources.

- Finally, the well is permanently killed through methods such as top kill or mobilization of a drilling rig to drill a relief well. Once killed, it is permanently plugged and abandoned.

Upgraded U.S. regulations, standards, and practices post-Macondo make the likelihood of a major well control event extremely unlikely. Steps taken to improve safety include certification by a licensed professional engineer that there are two independently tested barriers across each flow path and that the casing design and cementing design are appropriate, along with independent third party verification of the BOP. These engineering safeguards are backed up by requiring strict adherence to operations integrity management systems as part of an overall culture of safety and risk management.

Additional well control devices and techniques are now available that are independent of the controls on the drilling rig. Combined with performance-based risk assessment, these systems offer a dramatic reduction in worst-case discharge volumes and form a superior alternative to the requirement for same season relief well and/or oil spill containment systems. Such measures do not provide ultimate well kill and may not obviate the need for a relief well, but they do reduce urgency such that there is no net risk benefit to killing the well in the same season. Examples of these devices are capping stacks that can be quickly deployed after an incident and subsea shut-in devices that are installed on the well during the drilling process. Multiple spill prevention measures and barriers are currently designed into the wells, and these barriers are defined and specified in American Petroleum Institute/International Organization for Standardization (API/ISO) standards and U.S. offshore regulations. Drilling fluid, casing design, cement, and other well components are the primary barriers and the blowout preventers (multiple redundancies) are the secondary barriers to prevent a release to the external environment.

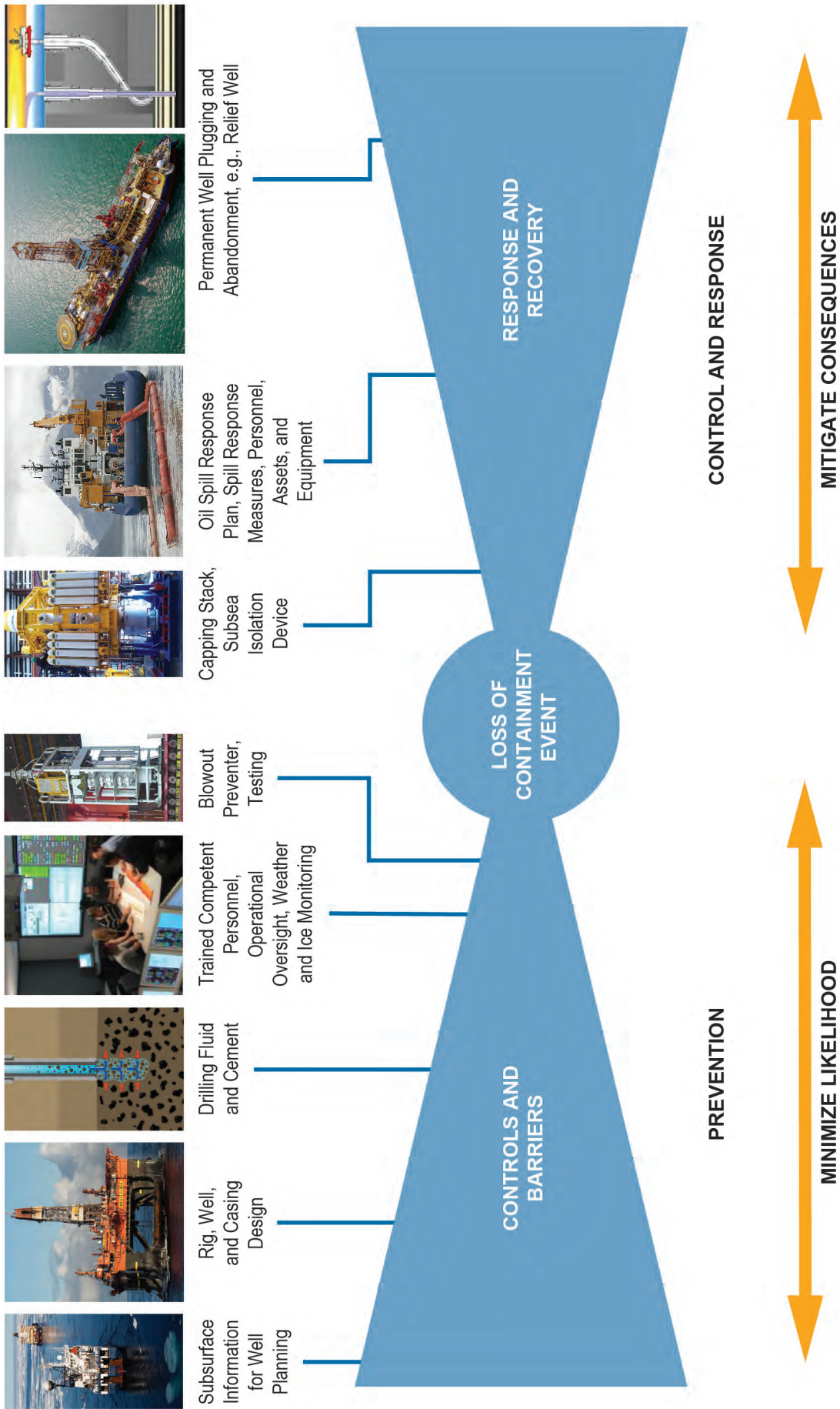

Sources, left to right: Subsurface Information for Well Planning – ION Geophysical; Rig, Well, and Casing Design – ExxonMobil; Drilling Fluid and Cement – Shell; Trained Competent Personnel – Shell; Blowout Preventer – Cameron; Capping Stack – Trendsetter Engineering Inc.; Oil Spill Response Plan – Shell; Permanent Well Plugging and Abandonment, e.g., Relief Well – Shell, ExxonMobil.

**Figure 8-1.** Offshore Drilling Spill Prevention, Control, and Response Technologies and Practices

Arctic well design and construction follows these standard offshore well practices. Arctic-specific hazards, including deep-keeled ice features and surface ice, require additional mitigations but do not alter the basic well design and construction practice—and prevention of loss of well control. Permafrost and methane hydrates, if present, require special considerations, including drilling fluid and tubular selection and control of heat, all within established and proven practices.

Prevention will always be the first and foremost priority. However, regardless of how many layers or barriers are put in place, the risk can never be reduced completely to zero. Accepting that reality, the need to prepare for the worst case in the highly unlikely event of losing well control assumes a high importance. This need to plan and exercise to carry out an effective response is at the heart of every Oil Spill Response Plan. The overall goal of spill response as shown in the diagram is to limit the potential damage caused by an accidental release by employing the most effective suite of countermeasures in a given situation. Making sure that responders have the flexibility to implement the best response options is the key to success in achieving this goal.

## Arctic Oil Spill Response

At present, all exploration activities in the Alaskan offshore take place in the summer period with predominantly open water, extensive daylight, and the potential for temporary ice incursions in extreme years. Drilling activities are not currently permitted into the freeze-up period. Consequently, the Oil Spill Response Plan is designed primarily around a conventional open water response with contingencies to deal with the possibility of encountering drift ice for short periods. While operationally challenging, the presence of ice in the summer may provide a related benefit in the form of generally lower sea states.

Oil Spill Response Plans for possible future extended-season exploration drilling or production will need to incorporate enhanced response strategies and ice management systems that can deal with more severe winter ice cover, extreme cold temperatures, and darkness. Proven nearshore response tactics to tackle these operating environments are already in place, developed through decades of planning and drills conducted, for example, for the Prudhoe Bay and Alpine fields, both in Alaska.

In light of the recognized challenges of responding to any offshore spill in a remote area such as the Arctic, it is important to highlight one significant advantage that ice cover can provide—planning time. Extremely rapid response is critical to combating spills in open water because of the dynamic nature of marine spills—oil slicks can rapidly spread to become extremely thin, break into many small slicks, and strand on shorelines. The outcome of a spill in open water is often determined within a matter of hours, allowing little time to assess key decisions and implement best strategies. In contrast, the presence of a significant ice cover (60% or more) can significantly slow the spreading rate, contain oil in relatively small areas, and potentially prevent or delay shoreline oiling. The benefit of time cannot be overstated, given the challenges of deploying resources in remote areas under extreme conditions.

Over the past four decades, the oil and gas industry and federal government have made significant advances in being able to detect, contain, and clean up spills in Arctic environments. Many of these advances were achieved through collaborative international research programs with a mix of industry, academia, and government partners (for example, the Minerals Management Service, the predecessor to the current BSEE). Much of the existing knowledge base in the area of Arctic spill response draws on experiences with a number of key field experiments, backed up by laboratory and basin studies in the United States, Canada, Norway, and the Baltic countries over the past 45 years. Much of the documentation for this work was published in proceedings of oil spill conferences such as the International Oil Spill Conference, InterSpill, and the Arctic and Marine Oilspill Program technical seminar.

Basic response strategies for spills in ice, adopted for an ice environment, use the same general suite of countermeasures (modified and adapted for use in ice) used elsewhere in the world, including:

- Mechanical containment and recovery with booms and skimmers in open water and very open pack ice, and skimmers extended from vessels directly into trapped oil pockets in heavier ice.
- Most spills are of a small volume, and mechanical recovery is used for the response operation as the oil is localized and the equipment is available at the location or nearby depot.

- Dispersants, applied from the surface (by airplanes, helicopters, or vessels) with mechanical mixing energy added as needed in certain ice conditions or subsea.
- A combination of strategies to concentrate the oil and burn it in situ. In an Arctic environment these can involve containment against natural ice edges without booms, fire resistant booms in open water or very open drift ice, and herding agents to thicken oil in open water and intermediate ice concentrations.
- Detection and monitoring while potentially planning a later response (e.g., burning on ice in the spring).
- Natural attenuation through evaporation and dispersion (i.e., no active response).

There is an extensive background of knowledge regarding oil spill behavior in Arctic conditions as well as the effectiveness and applicability of different response strategies in ice and cold water. Technology enhancements through collaborative research will continue to improve the operability and effectiveness of different response systems in ice. An equal or perhaps greater challenge involves integrating a diverse set of stakeholder groups, including Arctic community residents and regulators, into a collaborative effort to resolve uncertainties and build confidence. An important goal of this effort is to permit responders to rapidly employ the most effective and environmentally acceptable response options, including controlled burning and dispersants, as real-time conditions dictate. Promoting mutual understanding of the benefits, limitations, and trade-offs of different response tools will go a long way toward achieving this goal. By collaborating in joint industry programs (JIPs) and other research efforts, industry and regulators will stay up to date on advancements to technology and new innovative technology that is developed by manufacturers and technology companies, as well as by work done by OSR organizations.

Even under the best of conditions, one can never expect to recover or eliminate all of the oil spilled. A successful response limits damage to the environment by using the full range of available countermeasures in the most effective manner. An important means to enable success in an emergency is to review and update federal and state planning standards

and regulations to make sure they reflect the latest technologies, realistic operational and environmental constraints, and practical levels of response capability. The type and number of resources that can be maintained and operated safely and effectively for a given area, project, or facility should reflect a careful assessment of the most probable spill events that might occur, while recognizing that backup resources can be cascaded in within a short period of time to support a more serious spill event.

The ongoing Arctic Response Technology Joint Industry Programme (ART JIP) is the most significant research initiative of its kind ever launched. Bringing together the world's leading Arctic scientists and engineers, many of whom were involved in prior work, this program was initiated in 2012 as a collaboration of nine international oil and gas companies (BP, Chevron, ConocoPhillips, Eni, ExxonMobil, North Caspian Operating Company, Shell, Statoil, and Total). These companies have come together to further enhance industry knowledge and capabilities in the area of Arctic spill response as well as to increase understanding of potential impacts of oil on the Arctic marine environment.

Industry regularly meets with regulators, equipment manufacturers, academia, researchers, OSR organizations, and other stakeholders in many different forums such as:

- Oil Spill Conferences—International Oil Spill Conference (IOSC), Interspill, Spillcon, Arctic and Marine Oilspill Program, Clean Gulf, Clean Pacific, Offshore Technology Conference (OTC), Arctic Technology Conference, etc.
- Arctic Council's Emergency Prevention, Preparedness and Response Working Group
- Interagency Coordinating Committee for Oil Pollution Research meetings
- International Petroleum Industry Environmental Conservation Association's committees and meetings
- American Petroleum Institute's Spills Advisory Group.

Forty-five years of intensive research into oil spill behavior and response in ice-covered waters provides a strong foundation for Arctic oil spill contingency planning today. As with oil spill response in

temperate environments, there will always be a need to advance capabilities and knowledge. The ongoing research exemplified by the current ART JIP recognizes the critical importance of this issue to all key stakeholders concerned with protecting the Arctic environment. JIPs provide an excellent framework for collaboration between industry, regulators, researchers, scientists, academia, consultants, and other stakeholders to work on continuously advancing the knowledge and technology of oil spill response. The research and projects conducted under JIPs have always been considered as a noncompetitive area by industry, and it is best to bring the expertise together to work on identified issues. The National Research Council anticipates that future programs of this kind will involve a broad mix of local, industry, consulting, academic, and government experts to further our state of knowledge and strengthen our capabilities in being prepared with the best available technology to deal with any spill event, however remote the likelihood.

## **ARCTIC WELL INTEGRITY, SPILL PREVENTION METHODS, AND TECHNOLOGY**

### **Role of Technology in the Arctic**

Arctic well design and construction follows standard offshore well practices. Arctic-specific hazards, including deep-keeled ice features and surface ice, require additional mitigations, but do not alter the basic well design and construction practice—and prevention of loss of well control. Permafrost and methane hydrates, if present, require special considerations including drilling fluid and tubular selection and control of heat, all within established and proven practices.

U.S. regulations, standards, and practices that have been upgraded post-Macondo make the likelihood of a major well control event extremely unlikely. This includes certification by a licensed professional engineer that there are two independently tested barriers across each flow path, and that the casing design and cementing design are appropriate, along with independent third party verification of the BOP. Furthermore, there are requirements for adherence to operations integrity management systems combined with a culture of safety and risk management.

Additional well control devices and techniques are available that are independent of the controls on the drilling rig, and combined with performance-based risk assessment, offer a better alternative to the same season relief well (SSRW) requirement and/or oil spill containment systems (based on a worst-case discharge scenario). Examples of these devices are capping stacks that are deployed after an incident and subsea shut-in devices that are installed on the well during the drilling process.

### **History**

Exploration drilling operations in the Arctic began at Norman Wells in the Canadian Northwest Territories in 1920 and production began in 1932.<sup>4</sup> This field has been in continuous operation since then and has produced more than 250 million barrels of oil. Most of the production is from artificial islands in the Mackenzie River. These wells have maintained a long record of integrity even with seasonal flooding, ice jams, and ice scouring and have been constructed through the permafrost.

The Prudhoe Bay field on the Alaskan North Slope has been on continuous production since 1977 and these wells have been successfully drilled and produced through the permafrost.

There have been numerous Arctic shallow-water exploration wells in the U.S. and Canadian Beaufort Sea drilled since 1970.<sup>5</sup> These wells were drilled using gravel islands, ice islands, a concrete island drilling system, the Molikpaq (a steel caisson filled with granular material), ice-strengthened drillships (*Explorer I, II, III, and IV*), an axisymmetric circular-shaped floater (*Kulluk*) that was moored, a converted tanker used as a submersible (a single steel drilling caisson and later renamed steel drilling caisson), and two caisson retained island (CRI and Tarsuit) systems. All of these wells were drilled without loss of containment from the reservoirs. The first offshore Alaska Beaufort Sea production occurred in 1987 at the Endicott field using gravel production islands. No loss of containment has occurred from these wells during more than 20 years of production.

More than 350 wells have been drilled in offshore Arctic (or Arctic-like) drilling programs in Canada, Norway, Greenland, and the United States.<sup>6</sup> Almost 40 wells were drilled from floating ice platforms in

water depths up to 550 meters (1,800 feet). In addition, the industry has had successful and environmentally responsible Arctic drilling campaigns in the Cook Inlet, the Gulf of Alaska, Norton Sound, the Navarin Basin, and elsewhere. Exploration wells have been drilled in the North American Arctic over the past five decades, and these wells have been drilled in all of the major Arctic ice regimes.

There has also been more recent extensive offshore development in ice-prone regions offshore Sakhalin, Russia, although this region is clearly sub-Arctic. There are currently five offshore gravity-based structures named Orlan, Berkut, Piltun Astokhskoye A & B, and Lunskoye A. These offshore structures support drilling rigs, and oil has been produced since 1998.

Finally, the Grand Banks offshore Newfoundland is probably the best example of iceberg management in the offshore oil industry. The operators employ a large gravity-based structure with platform drilling rigs (Hibernia), surface wells, and subsea wells tied to floating production vessels (*Terra Nova* and *White Rose*). The subsea drilling has been conducted primarily using moored, floating semisubmersible rigs, but a jack-up rig has also been used.

These fields employ an extensive iceberg management program to minimize the risk of an iceberg reaching the surface structure or the subsea wells. Most of the subsea wells are located in excavated subsea drill centers where the christmas tree is located below the seafloor. The iceberg management program uses boats, aircraft, and a marine radar system to detect and track icebergs. Marine vessels use heavy cables with specially designed nets to tow and/or redirect icebergs that pose a threat to the structures.

## Current State of the Technology

The industry has developed the technologies and methodologies to design and construct wells so that a hydrocarbon release from the reservoir is highly unlikely and continuously works to improve this practice. In the drilling and construction of a well barriers to hydrocarbon flow are established. These barriers consist of drilling fluid of sufficient density, tubular goods (casing and tubing), cement, subsurface valves, the BOP (which contains redundant components),

christmas tree, and others. Loss of containment and the subsequent response can be more challenging in an Arctic environment than a sub-Arctic environment due to the potential presence of ice and the associated logistical issues. The prudent implementation of these barriers results in the prevention of a hydrocarbon release to the environment.

## Drilling Fluids

The drilling fluid (often called mud) is the primary barrier to prevent the influx of subsurface fluids such as reservoir hydrocarbons or formation brines. The drilling fluid is designed to have a density greater than the pore pressure of the fluid in the subsurface strata (rock). If the drilling fluid exerts more pressure than the formation pore pressure, an influx will not occur and hydrocarbons will remain in the subsurface rock, except for a very small amount that is released by the rock formation that has been drilled. The drilling fluid will create additional downhole pressure on the rock when the pumps are circulating the fluid during the drilling process. The formation fracture strength is determined after drilling out of the casing shoe and a few feet of new formation, and then pressure testing the rock until fluid begins to leak off (fluid enters the formation). This is referred to as the pressure integrity test (PIT) or formation integrity test (FIT) and is an important factor in well control. The drilling engineer uses pore pressure, mud density, and formation fracture strength to determine the setting depth of the casing strings. In U.S. federal waters, regulations also exist that specify the depth the next string of casing must be set to maintain an appropriate margin between mud weight and rock fracture strength as measured by the PIT/FIT.

Probably the most important aspects of well control and in keeping a well secure during drilling, completion, and workover/intervention operations are keeping the hole full of fluid and monitoring for kick (influx) detection. Kick detection is normally done using equipment located at the surface of the drilling rig. If formation fluid flows into the wellbore, a net increase in the closed volume drilling fluid system can be detected by volumetric sensors. A flow meter is also installed that can detect an influx. A trained drilling crew will detect this and take the necessary action, which normally involves closing the BOP before the influx can migrate to the surface.

## Casing and Wellhead Design

The casing and wellhead are the pressure vessels that contain pressures from the downhole formations. The design and performance of these are covered by API specifications. For casing and tubing, the API Specification 5CT, “Specification for Casing and Tubing,” and other API standards and references define dimensions, performance specifications, material properties, testing requirements, quality measures, and other aspects.<sup>7</sup> It should be noted that for low temperature applications such as the Arctic, API Specification 5CT allows the purchaser to specify low temperature tests for the impact testing (Charpy V-notch) to ensure the casing and tubing will be suitable for the environment.

Wellhead equipment is manufactured to proprietary specifications but tested to API standards such as a pressure test to 1.5 times the rated working pressure of the equipment. API Specification 6A, “Specification for Wellheads and Christmas Tree Equipment,” governs the manufacture and quality of these well components in the United States and many other parts of the world. To date, most wellhead equipment is manufactured to a range of 3,000 to 15,000 psi, which is suitable for Arctic reservoir pressures.

Safety and design factors are an important part of the integrity of the well. The engineer will calculate all loads that the casing and tubing could experience such as tension, compression, bending, internal pressure, external pressure, temperature, torsion, and others. Then a safety factor is applied to the calculated load and this load is compared to the performance rating of the tubular components (or working load of the equipment).

The quality of the casing and tubing strings is ensured by the pipe manufacturers, and verified by manufacturers’ qualifications, agreed quality requirements, audits, and sometimes third-party checks by the customer. API Specification 5CT requires non-destructive testing, material property testing, tensile strength measurement, yield strength measurement, ductility tests, Charpy impact toughness, and others, as well as hydrostatic pressure testing of the pipe. Supplemental inspection requirements allow the purchaser to include additional inspections and rejections for flaw sizes as small as 5% of the nominal wall thickness. In addition, torque-position or torque-turn quality assembly methods can be specified for the

threaded connections for casing and tubing. These quality assembly techniques help ensure that the pipe connections are tight and leak free at the assembled connection.

After the casing is run and cemented in the well, a pressure test is conducted to ensure integrity. The pressure and duration is specified by 30 CFR Part 250 for the U.S. federal waters.<sup>8</sup>

## Cementing

The cement is a critical part of the integrity of the well and is placed in the annulus between the casing and the borehole. The API Specification 10A, “Specification for Cements and Materials for Well Cementing,” governs the design, formulation, testing, and quality of oil field cement. The amount of cement that is pumped is based on a volumetric calculation of the borehole (logs, calipers, or flow measurements) and the casing diameter. The casing string that is connected to the BOP stack (conductor casing for subsea wells and surface casing for surface wells) is normally cemented to the surface at the wellhead (seafloor for subsea wells). For the other casing strings, the height of cement in the annulus is based on the desired degree of isolation. For hydrocarbon intervals in U.S. federal waters, the BSEE requires the top of cement to be at least 500 feet (measured length) above the shallowest hydrocarbon zone.

There exist several techniques and types of equipment that can improve the quality of the cement seal. Wiper plugs and fluid spacers are used to keep the cement from being contaminated by other fluids during the pumping operation. Float shoes and float collars are basically one-way check valves that allow the cement to pass from inside the casing to the annulus and prevent backflow into the casing. Centralizers are mechanical devices attached to the outside of the casing to help ensure a more uniform layer of cement between the casing and the rock formations.

Prior to pumping cement, the cement company calculates the formulation of the cement slurry and tests it in a laboratory to the downhole conditions (temperatures and pressures). The lab report confirms the compressive strength of the cement versus time. In addition, during the pumping operation, samples are collected at the surface and put into an oven to simulate the downhole environment. Drilling normally does not commence until the samples

have properly hardened and the times specified in the lab report are met.

After the cement has hardened, the isolation of the new hole from the upper zones can be verified by the pressure integrity test described earlier.

Bond logs are electronic wireline tools used to measure the integrity of the cement seal between the casing and the borehole (rock). This measurement can be done along the full length of the casing.

API Recommended Practice 65 Part II has identified several best practices to help ensure a good cement job (seal).<sup>9</sup> The BSEE has now incorporated this recommended practice in the Code of the Federal Register (CFR).<sup>10</sup>

## Blowout Preventers

The surface and subsea BOP stacks are similar and should be considered as secondary barriers to the drilling fluid. Both use annular and ram preventers where the annular preventer can seal around nearly any geometry and the ram preventer is designed to seal around a specific pipe diameter. Two other types of preventers are blind shear rams that can cut pipe and seal the bore and casing shear rams that typically cut larger diameter pipe (casing) or heavier wall thickness pipe. The BOP stack with multiple components is attached to the wellhead, with the surface BOP located just under the rig floor and above sea level and the subsea BOP stack located near the seafloor.

A typical BOP stack would have at least one annular preventer and two or more ram preventers. A subsea BOP stack has a lower marine riser package (LMRP) attached by a hydraulic connector to the rest of the BOP stack (normally all of the ram preventers) that is connected to the wellhead. The LMRP connector allows the drilling rig to disconnect from the well, but still leaves the main part of the BOP stack attached to the wellhead to keep the well secure.

The BOP stack operates on hydraulic pressure supplied by a bank of accumulator bottles located at the surface and also subsea (specific for subsea stacks). Regulations specify two independently powered pumping methods for charging the accumulators, and these can be hydraulic, pneumatic, or electric. The volume and capacity of the accumulator bank

and control system is tested to ensure that all critical BOP functions can be operated without recharging. The industry has BOP equipment designed for working pressures as high as 15,000 psi. It is expected that this should be sufficient for the Arctic reservoirs based on what is known today.

If a hydrocarbon influx or kick does occur, the drilling crew needs to respond promptly, and they are trained to do so. Since there are multiple preventers in the stack, redundancy exists. Once the BOP is closed, the size and energy of the influx is constrained. The normal practice if a kick occurs is to close one of the BOP components and then circulate out the influx. The hydrocarbon influx is circulated around the BOP stack via the choke line to the choke manifold. To prevent further hydrocarbon influx, the bottom-hole pressure is maintained above the formation pressure by manipulating the choke. The choke valve is connected to a mud gas separator, and gas is vented out a flare line safely away from the rig crew.

The rig supervisors, tool pushers, drillers, and assistant drillers are trained on these well control techniques via computer simulators in well control schools similar to training methods used by other industries. The crews can also practice their well control and choke expertise at casing points with a technique called a power choke drill.

BOP stacks have redundancy to prevent the flow of hydrocarbons since there are several independently sealing components. For a typical surface BOP, there would be three or more preventers (5,000 psi or greater service), and for a typical subsea BOP stack there would be five or more preventers depending on the expected working pressure as stated in API Standard 53.<sup>11</sup> An illustration of a typical subsea BOP stack is shown in Figure 8-2.

## Training and Competence

Human factors are recognized by the industry as an important aspect of maintaining the integrity of the well. A variety of well control drills are required by the U.S. regulations such as:

- Weekly pit exercises to test the crews on their ability to detect a simulated influx of formation fluid (kick) while drilling. The crew must recognize that the kick has occurred, space out the drill string in



Photo: Cameron.

**Figure 8-2.** Typical Subsea BOP Stack

the proper location in the BOP stack, and secure the well using the BOP controls.

- Weekly trip exercises to test the crews on their ability to detect a simulated kick while tripping the drill string into or out of the well. The crew must space out the drill string in the proper location in the BOP stack, secure the well using the BOP controls, and stab the rig floor safety valves into the top of the drill string.
- Various other drills are conducted with the rig crews such as fire drills, abandon rig drills, muster point drills, man overboard drills, etc.

Rig supervisors are required to take a certified well control course every 2 years and the key members of the rig crew are also required to be certified in this same training for U.S. federal waters as well as some other countries.

Many operators conduct safety seminars and Drill Well on Paper (DWOP) exercises with the drilling crews and service company personnel prior to the start of a drilling program. This builds a thorough understanding of the program, potential hazards, and mitigation steps prior to the drilling process. It is

not uncommon for the operator to conduct a thorough risk assessment of the drilling program before commencement and involve the drilling contractor and key service companies. And finally a written and approved drilling program is required prior to commencing the drilling operations. Any significant changes to a signed drilling program should be approved at the same level of management that approved the original program.

One of the most important human factors at the rig site is the accepted practice that anyone has the right to stop the work if he/she feels that it is unsafe. This is broadly accepted in the drilling industry today. Also, many drilling rigs use an observational safety program that encourages workers to watch out for one another and intervene as needed. This promotes a culture of “Nobody Gets Hurt.” Workers are encouraged to submit observation cards or STOP cards that show that the entire crew is engaged in safety.

Once drilling commences, there are several safety processes widely in use today. A job safety analysis (JSA) is a written description of the possible hazards and mitigation steps associated with a particular task. All workers involved in the task are required to participate in the JSA. Some companies refer to this as a job risk assessment (JRA). Toolbox talks are also held at the work site just prior to commencing the task. This is a final opportunity to assess risks and apply mitigations.

## Safety Processes and Risk Management

Post-Macondo, the BSEE instituted a requirement for a Safety and Environmental Management System (SEMS) that was codified under API RP 75, “Recommended Practice for Development of a Safety and Environmental Management Program for Offshore Operations and Facilities.”<sup>12</sup> This document requires the operator and owner (rig contractor) to develop a management system designed to promote safety and environmental protection during the performance of offshore oil and gas operations. This recommended practice addresses the identification and management of safety hazards and environmental impacts in design, construction, start-up, operation, inspection, and maintenance, of new, existing, or modified drilling and production facilities. The objective of this recommended practice is to form the basis for a Safety and Environmental Management Program (SEMP). By developing a SEMP based on

this document, owners and operators will formulate policy and objectives concerning significant safety hazards and environmental impacts over which they can control and can be expected to have an influence. Some operators refer to this as their operations integrity management system or operations management system.

The SEMP requires the following elements:

- Safety and environmental plan
- Hazards analysis
- Management of change
- Operating procedures
- Safe work practices
- Training
- Assurance of quality and mechanical integrity of critical equipment

- Pre-startup review
- Emergency response and control
- Investigation of incidents
- Audit of safety and environmental management program elements.

Operators conduct thorough risk assessments of their drilling programs prior to commencement. The risk assessment process includes the key participants in the drilling program, such as the operator’s engineers and operations personnel, rig owner personnel, service company personnel, and sometimes other experts. Hazards are identified and prevention techniques and mitigation measures/procedures are discussed and documented. The consequence and probability of each key hazard/event are analyzed, and the risks are managed through documented operational practices and procedures. An example of the process is shown in Figure 8-3.

### RISK ASSESSMENT MATRIX

SEVERITY	CONSEQUENCES				INCREASING LIKELIHOOD				
	PEOPLE	ASSETS	ENVIRONMENTAL	REPUTATION	A	B	C	D	E
					Never heard of in the industry	Heard of in the industry	Has happened in the organization or more than once per year in the industry	Has happened at the location or more than once per year in the organization	Has happened more than once per year at the location
0	No injury or health effect	No damage	No effect	No impact					
1	Slight injury or health effect	Slight damage	Slight effect	Slight impact					
2	Minor injury or health effect	Minor damage	Minor effect	Minor impact					
3	Major injury or health effect	Moderate damage	Moderate effect	Moderate impact					
4	PTD* or up to 3 fatalities	Major damage	Major effect	Major impact					
5	More than 3 fatalities	Massive damage	Massive effect	Massive impact					

\*Permanent total disability

**Figure 8-3.** Risk Assessment and Management Process

The risk assessment matrix is a 6 by 5 matrix that is used for qualitative assessments of risk and for the prioritization of activities and resources. It is based on the concept of applying experience of events or incidents in the past to predict risks in the future. The components of the risk assessment matrix are:

- The vertical axis represents consequences (severity levels 0 to 5) in terms of harm to people, damage to assets, effect of the environment, and impact on reputation.
- The horizontal axis represents increasing likelihood (levels A to E) of the consequence under consideration.
- Boxes in the matrix represent levels of risk, increasing from top left to bottom right corners of the matrix.
- The matrix is divided into green, yellow, and red areas to illustrate and increasing level of risk.

The risk assessment process is then operationalized. Engineers, operations personnel, service companies, rig personnel, and others implement the findings and mitigations, close out items, and loop back lessons learned for future operations.

## Unique Technical Challenges

### Permafrost

In many cases, Arctic wells must be designed to penetrate through permafrost formations. Onshore on the Alaskan North Slope, there have been numerous wells successfully producing in permafrost regions for decades (while maintaining operational integrity), and the industry has clearly demonstrated appropriate design and construction methods for these wells.

A large number of offshore Arctic wells have been safely drilled through permafrost zones by controlling bottom-hole pressure and temperature during the drilling and completions process.

A casing string is normally run from the surface through the permafrost and into competent rock below the permafrost. This casing string (usually the surface casing for surface wells and the conductor casing for subsea wells) is cemented from the shoe to the wellhead. Since permafrost thawing can create some subsidence in the permafrost zone, the casing material selected needs to have good ductility and strain capacity.

Some effective drilling and completion practices used for onshore Arctic wells that could also be applied to offshore Arctic wells are as follows:

- Use of an insulated conductor set deep enough to resist subsidence
- Use of a mud cooler for drilling the permafrost hole section to reduce washout due to thawing
- Specially formulated cement for low temperature: permafrost (low heat of hydration) cement has been used in the Canadian Beaufort Sea wells in which intersecting permafrost was planned. Both the conductor and surface casings have been fully cemented with permafrost cement.
- Thermosiphons placed around the conductor that circulate fluids for heat exchange to reduce/eliminate permafrost melting due to production
- Vacuum insulated tubing to prevent heat transfer from the reservoir to the permafrost zone
- Insulating packer fluid: an oil-based system that has lower conductivity and less convection, thus reducing heat transfer from the reservoir
- Methanol injection for hydrate prevention on cold start-up
- Increased brine (completion fluid) true crystallization temperature to account for the low temperature environment.

### Capping Stacks

Subsea well capping operations were widely publicized during the Macondo subsea blowout in 2010, but the well capping technique has been used by industry for surface well blowouts for many decades. The basic steps of capping a subsea well are:

1. Assess the well and well site conditions
2. Mobilize the required dispersants, debris removal and capping equipment and personnel
3. Clear any debris and prepare the BOP or high-pressure wellhead for capping stack installation
4. Deploy the capping stack (Figure 8-4) subsea and connect it to the flowing well
5. Stop or divert the well flow by closing the capping stack sealing elements.

The well casings and equipment below the capping stack must have adequate pressure and structural integrity for the well capping to be successful for a full



Photo: Shell.

**Figure 8-4.** Shell Arctic Capping Stack

shut-in scenario. BSEE requires this scenario to be documented through the worst-case discharge analysis, which assumes a full hydrocarbon column from the reservoir to the wellhead. Current technology is capable of containing pressures as high as 15,000 psi (at the wellhead), which should be sufficient for Arctic reservoirs.

The capping stack is designed to be attached to the mandrel or hub of the high-pressure wellhead or BOP via a wellhead connector. The heart of a capping stack is the wellbore sealing elements, which are typically either a single or dual blind rams that are controlled by a subsea accumulator package and operated by a remote operated vehicle (ROV).

Capping stack BOP rams and valves are operated hydraulically using an external fluid source via an

ROV hot stab and/or manually by an ROV torque tool. Capping stack designs also provide pressure and temperature sensors to monitor well conditions and the capability to inject hydrate inhibitors or other chemicals into the capping stack during, or after, well capping operations.

Since Macondo, capping stacks have become a standard part of the subsea drilling emergency response planning.<sup>13</sup> Several cooperative industry consortiums, individual companies, and operators have designed and built capping stacks to ensure that industry has a significantly enhanced capability to respond to a subsea well blowout. These entities include Marine Well Containment Company, Oil Spill Response Limited (OSRL), which is responsible for managing and maintaining the four Subsea Well Response Project capping stacks, Oil Spill Response and Prevention Advisory Group, Helix Well Containment Group, Wild Well Control, and some operators. There are approximately 20 capping stacks currently available in industry at this time. These capping stacks are strategically located proximal to many offshore operating areas such as Alaska, the Gulf of Mexico, Brazil, the United Kingdom, Norway, Angola, South Africa, and Singapore. Shell's Alaska Exploration Plan includes a pre-staged capping stack. The capping stack procedures and location are part of a plan submitted to the regulators.

In addition to the capping stacks, industry has amassed a sizeable stockpile of dispersants available to allow for an effective response to a spill or well blowout. The industry has also enhanced the availability of associated support equipment that is required of a response, such as dispersant delivery systems, containment domes, subsea accumulator modules, shipping containers, hydraulic flying leads, flexible flowlines, debris removal tools, etc.

To ensure that the industry not only has subsea well capping equipment available but also can effectively respond to an incident, full-scale deployment drills have been performed.

Although there are solutions for shallow water, most are based on very specific conditions, well flow rate, and limited ice. Shallow water with ice present poses unique challenges. An alternate to well capping in shallow water is a prepositioned device described in the subsequent section.

## Well Kill Options

If the drill string is intact and near the bottom of the well, the normal practice to kill the well is to circulate a drilling fluid with a greater density than the pore pressure of the formation. By a combination of a closed BOP stack and manipulation of the choke at the surface manifold, a constant bottom-hole pressure greater than the formation pressure is maintained, and the influx is circulated out of the well; this is a standard operation.

However, if the drill string is not in the well, an option is bullheading kill-weight fluid from the surface down the kill line below the closed blind shear ram (or blind ram). This is also the method to kill the well if the BOP stack is compromised and a capping stack is installed after a blowout. As long as the casing has sufficient integrity, this method is also acceptable and was used to kill the Macondo well in the Gulf of Mexico in 2010.

## Subsea Shut-In Devices

Subsea shut-in devices, sometimes referred to as seabed isolation devices, mudline containment

devices, prepositioned capping devices, or alternative well kill systems, are pre-installed on the high-pressure wellhead housing below the rig's BOP stack. The advantage of this "drill-through" arrangement is that the pre-installed shut-in device dramatically reduces the response time to seal the wellbore. This quick response characteristic could be advantageous in remote locations to ensure the well is secure if the rig needs to leave or is forced off location without the proper time available to secure the wellbore by more traditional methods. An example of this situation in the Arctic environment could be encroaching ice that causes a rig to leave location and prevents its return for some extended period of time. Thus, some operators have proposed a subsea shut-in device as an equivalent alternative to a single season relief well for the Arctic region.

The subsea shut-in devices (Figures 8-5 and 8-6) are generally similar to capping stacks with a few notable features and enhancements. Because they are installed between the high-pressure wellhead and the BOP, and are drilled-through, they have a rated working pressure and bore consistent with the rig

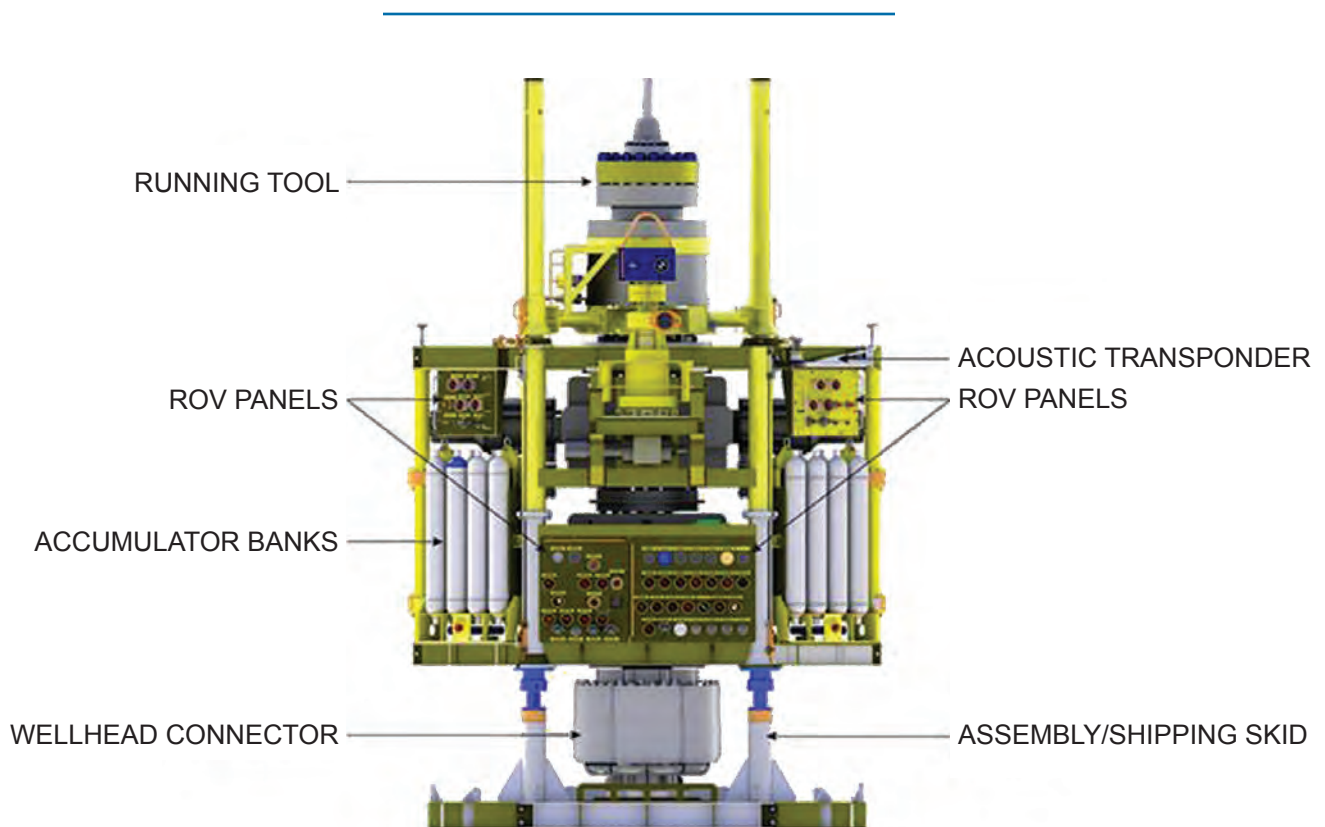

Source: Trendsetter Engineering, Inc.

**Figure 8-5.** External View of a Subsea Shut-In Device

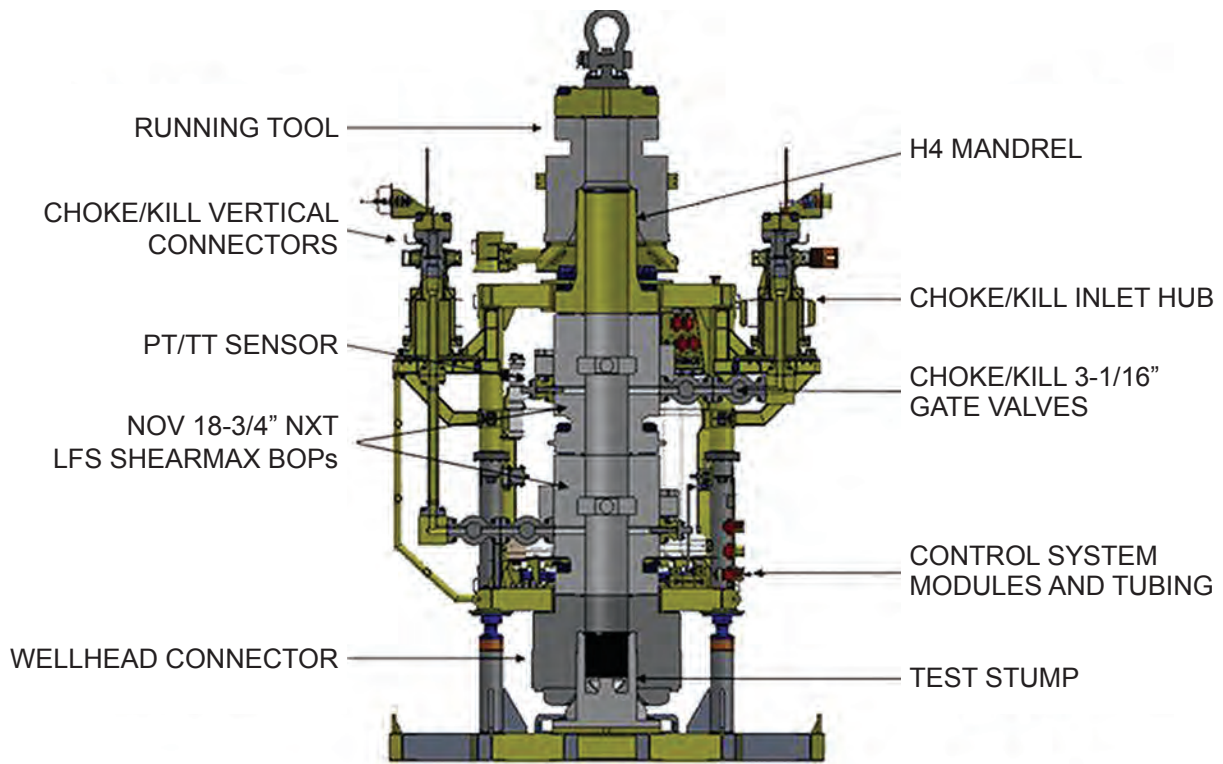

Source: Trendsetter Engineering, Inc.

**Figure 8-6.** *Internal View of a Subsea Shut-In Device*

BOP, and the sealing elements are single or dual BOP blind shear rams capable of shearing drill pipe and certain well casings. Due to the additional weight and height, the shut-in device adds to the BOP “stack-up” on the wellhead, the well design must be capable of resisting the additional axial, bending, and shear loads caused by the equipment weight, drilling riser loads, and rig offset.

The subsea shut-in device has its own independent control system and hydraulic fluid supply and thus does not rely on, and is operated independently from, the rig’s BOP control system. The shut-in device control system design includes enhanced levels of redundancy from the rig’s control system as it is equipped with an independent acoustic control system and subsea accumulator bottles that allow select critical functions such as the closing of a ram and valves to isolate well flow with or without ROV intervention. Similar to capping stacks, the shut-in device functions can also be performed with fluid provided from an external source (i.e., subsea accumulator module) via an ROV hot stab, or manually by a ROV torque tool. The acoustic control system

can also be programmed to monitor and store pressure and temperature data for long shut-in periods (depending on sampling rate) for future download and review.

Examples of subsea shut-in devices are Cameron’s single BOP Environmental Safe Guard system, Chevron’s dual ram Alternative Well Kill System (as shown in Figure 8-7),<sup>14</sup> and Trendsetter Engineering’s Enhanced Subsea Shut-in Device (as shown in Figure 8-8), which has been deployed successfully in the Kara Sea in relatively shallow water (80 m). These devices can be integrated into the existing BOP stack or positioned between the wellhead and the BOP stack. In all cases, they can be operated independently of the drilling rig.

There are other versions and nomenclatures for this type of device. ConocoPhillips calls their system a Pre-positioned Capping Device or Auxiliary Safety Isolation Device. These names imply that the device can be used on any type of installation and avoids the assumption that the device would have to be subsea. The industry also uses the term Shutoff Isolation Device, which implies the device could be



Source: Chevron.

**Figure 8-7.** Chevron Alternative Well Kill System



Photo: Trendsetter Engineering Inc.

**Figure 8-8.** Trendsetter Enhanced Subsea Shut-In Device

positioned above or below sea level. For a gravity-based structure, the device could be placed on a lower deck in an area that was protected from fire/explosions on the upper deck.

The decision to use a capping stack or prepositioned device for shut-in is based on an analysis of the well and environmental conditions. If ice conditions, water depth, and/or anticipated well conditions or combinations of these would complicate well capping, then a prepositioned device may be the most efficient option.

### Ice Protection and Ice Management

The ice management plan needs to include the operating limits for the drilling rig and the fleet of support vessels combined with a monitoring program to ensure that the vessels are not exposed to conditions outside their operating range. For Arctic operations, there are normally more support vessels deployed than in non-Arctic regions due to remoteness and to assist with ice management. Anchor handling boats can be used to help deflect icebergs such as is done offshore Newfoundland. High-speed crew boats can be used to survey a broader area and deploy environmental instruments. And icebreaker vessels can be used to clear a path for the rig and other support vessels.

Operators will normally collect metocean data and seasonal ice data for the region to be drilled over as long a period as the data exist. Exploration drilling with mobile offshore drilling units (MODUs) will typically be conducted during the ice-free season.

An ice monitoring system needs to be in place. This could include any or all of the following:

- Weather forecasts
- Visual data from all available ships in the operations spread
- Marine radar data, including ice radar
- Seawater temperature (can be a good predictor of impending sea ice)
- Sonar data
- Satellite data
- Metocean data from observations, instruments, and from data buoys in open water and ice

- Reconnaissance by air (fixed wing, helicopter) or UAV (underwater autonomous vehicles).

The response for ice hazards approaching a drilling rig is very similar to those developed by the industry for tropical regions in response to hurricanes, cyclones, or typhoons. If a hazard is detected via the monitoring program or the weather forecast, and it is determined that the drilling rig needs to leave the location, several well-practiced steps can commence. The open hole interval will be secured by cement plugs, and/or a mechanical retainer (e.g., bridge plug) will be set near the bottom of the last casing string (i.e., shoe). Next drill pipe is run near the bottom of the last casing string. The drill pipe is secured to the well by either a storm packer placed in the casing string below the seafloor or by hanging off at a tool joint in the middle pipe ram of the BOP stack. The upper part of the drill string is pulled out of the well and the blind shear rams are closed above the remaining drill string in the well. The Lower Marine Riser Package connector is remotely disconnected from the lower part of the BOP stack (contains the ram preventers), the riser is pulled to the surface, and the drilling rig can sail away. It should be noted that the ram preventers contain mechanical locks that keep the well secure even if the hydraulic control pressure is lost.

## Relief Well Drilling

A relief well is a directional well drilled to communicate with a nearby uncontrolled (blowout) wellbore and control or stop the flow of reservoir fluids. If it is assumed that the original rig is disabled, a second rig would need to be mobilized and brought into proximity of the flowing well. The second rig will need to be equipped with casing, cement, drilling fluids, and wellhead equipment to construct the relief well.

The Minerals Management Service published two papers on statistical data for blowout wells in the Outer Continental Shelf of the United States.<sup>15,16</sup> These studies covered the 35 years from 1971 to 2006. These reports state, “Although relief wells were initiated during several of the blowouts, all of the flowing wells were controlled by other means prior to completion of the relief wells.” Also, “significant volumes of liquid hydrocarbons were not associated with any of the drilling blowouts.” The reports state that “continued success will depend on sustained efforts by industry and government to improve safety manage-

ment practices related to drilling and well control.” The federal government and the offshore industry significantly adjusted the regulations and standards in the United States after the Macondo incident in 2010.

In Arctic environments, it may be more prudent from an environmental standpoint to focus on prevention and alternate methods than on a relief well plan. Prevention through prudent well design and operations should be the primary method for containment. Alternate methods such as capping stacks or subsea shut-off devices are a secondary method of spill mitigation and containment. A relief well under good weather conditions may take 30 to 90 days plus rig mobilization, whereas a capping stack could be installed significantly sooner, and a subsea shut-in device could be activated in minutes.

Some regions of the world (e.g., Canada) specify a same season relief well (SSRW) capability for Arctic drilling. In the Arctic, a similar, and in some cases higher, level of protection to a SSRW may be achieved with appropriate well designs that are executed with the right equipment, best available technology, and using proven drilling practices by personnel who are trained and competent. Both Chevron Canada and Imperial Oil Resources have requested an equivalent approach to the SSRW for the Canadian Beaufort Sea that includes incident prevention as well as securing the well and response plans.

## Regulations for Drilling and Well Construction

Post-Macondo (April 2010), the BSEE was formed. Prior to this, the Minerals Management Service had jurisdiction over U.S. offshore drilling plans and operations. Numerous new safety rules were implemented into the Department of the Interior’s Code of Federal Register, namely 30 CFR Part 250, which governs offshore drilling in federal waters (Federal Register, NTL No. 2010-N06, NTL No. 2010-N10).<sup>17,18,19</sup> Some of the key new provisions that have been adopted to improve the safety and secureness of the drill wells include the following:

- Independent third party verification that the blind shear rams are capable of shearing any drill pipe body (excluding the bottom-hole assembly) in the hole under maximum anticipated wellhead pressure.

- Independent third party verification that the subsea BOP is designed for the intended service and for the specific rig.
- Certification by a licensed professional engineer that there are two independently tested barriers across each flow path and that the casing design and cementing design are appropriate; also a negative pressure test is required to ensure proper installation of casing and cement for the intermediate and production casing strings. Where it is not practical to establish two independently verified barriers, a documented risk assessment should be conducted to demonstrate that process safety risks are managed to as low as reasonably practical.
- An ROV must be capable of closing one set of pipe rams, closing one set of blind shear rams, and unlatching the lower marine riser package.
- Testing of all ROV intervention functions on the subsea BOP stack during the surface stump test and testing of at least one set of rams during the initial test at the seafloor.
- Well control training is required for selected rig personnel.
- The cementing program must comply with API RP 65 Part II, “Isolating Potential Flow Zones During Well Construction.”
- The BOP stack must be designed and maintained in accordance with certain provisions of API Standard 53, “Blowout Prevention Equipment Systems for Drilling Wells.”

The BSEE has numerous requirements for BOP tests. The BOP stack has to be fully pressure tested every 14 days for subsea BOPs and every 21 days for surface BOPs, and a function test has to be conducted every week. Also, the BOP stack has to be pressure tested upon initial hook-up to the wellhead and after each casing string is set. The BOP stack must be tested to a low pressure (250 psi) and then the maximum anticipated wellhead pressure.

Another BSEE regulation added after Macondo was to make parts of API Standard 53 mandatory.<sup>20</sup> Also, the API upgraded this document from a recommended practice to a standard. Some key provisions of this standard are as follows:

- Surface BOP stacks must have at least 3 BOPs for 5,000 psi service, 4 BOPs for 10,000 psi service, and 5 BOPs for 15,000 psi service.
- All sealing ram preventers must be equipped with locking devices.
- Surface and subsurface well control systems must have two remotely operated chokes on the choke manifold for 10,000 psi service or greater.
- There must be two control stations, one located near the rig floor and the other distant from the rig floor.
- All subsea BOP stacks must have at least 5 preventers with a minimum of one annular, two pipe rams, and two shear rams of which one must be a sealing type.
- Subsea BOP stacks must have two (fully redundant) control pods. There must also be at least two surface to subsea power fluid supply lines.
- An emergency disconnect sequence (EDS) is required for all dynamically positioned rigs and is optional for a moored rig and must be operable from two separate locations on the rig. The EDS is a programmed sequence of events that operates the functions of the BOP stack to leave it in a desired state and then disconnects the Lower Marine Riser Package (LMRP) from the lower part of the BOP stack.
- An autoshear system must be installed on all subsea BOP stacks. The autoshear system closes the blind shear ram if the LMRP is disconnected.
- A deadman system is required on all subsea BOP stacks. The deadman system automatically closes the blind shear ram if electrical and hydraulic power are lost subsea.
- Subsea BOP stacks must be equipped with ROV intervention panels that allows for the function of the blind shear ram, one pipe ram, the corresponding ram locks, and the LMRP connector.

## Prudent Development Policy and Regulatory Challenges

There are several policy and regulatory challenges that inhibit prudent development of the offshore Arctic.

***Offshore drilling season not based on drilling system capability.*** The prescriptive provision for a same

season relief well with drilling limited to the open water season currently defines the latest date that the hydrocarbon bearing zone can be entered, which further challenges the lease terms.

**Regulatory flexibility.** Prescriptive (current) versus performance based (i.e., risk based) regulations do not necessarily account for the strengthened standards following the Macondo incident (2010) nor the commitment made for capping solutions. Prescriptive regulations may drive ineffective and costly technologies and requirements that do not necessarily reduce risk or offer a significant contribution to environmental protection and could be detrimental to prudent development.

**Complexity of the regulatory regime.** The Exploration Plan approval is required from a multitude of government agencies creating the potential for delay, which puts pressure on lease terms and risks the future production start date. Streamlining government approval processes and/or increasing the transparency of the various government requirements for approval can reduce government and industry costs associated with approvals and reduce approval delays. Measures that reduce regulatory and permitting timelines and give greater regulatory predictability to operators can contribute to maintaining sustained investment in an operating environment that already faces the challenge of longer development timelines.

## **Technology Capability Enhancement Opportunity**

Two areas that the industry has identified as impediments to prudent development of the offshore Arctic are the requirements for a same season relief well and the need to have oil spill response capability equal to a worst-case discharge scenario. A possible resolution to this would be a joint industry and U.S. government study to develop a methodology to quantify the risks and benefits of the multiple barrier technologies, using appropriately detailed reliability data and assessments. The goal of this study would be to achieve source control of the well in the most rapid manner so as to minimize the potential spill volume. The study should consider overall acceptability of risk levels, contribution of different risk mitigation practices, and other mitigations to risks that could be incorporated into Arctic operations. Risk levels of different approaches to environmental protection,

current technology, and practices/methods compared to a same season relief well can be part of the study. Practices in assessment techniques from the nuclear, aviation, and petrochemical industries such as accident sequence precursor analysis could be applied.<sup>21</sup>

This risk-based methodology could then be used on a well-by-well basis to document the acceptability of proposed barrier requirements in order to reduce the risk to an acceptably low level (i.e., a performance-based requirement) as opposed to prescriptive requirements. If this methodology shows that environmental risks are less (or not significantly different) than a SSRW, then SSRW and other spill response requirements could be eliminated for appropriate wells. This would extend the drilling season and facilitate exploration and development.

Industry is leading efforts to enhance well capping and shut-off technology. Identification and development of technologies that can lead to material advancements (e.g., reliability, speed, and practicality) are potential areas for industry and government collaboration.

Offshore Arctic drilling could benefit from more data or studies supported by the U.S. government on metocean, climate, and seafloor bathymetry. This would enable operators to design systems, structures, rigs, and support vessels specifically for their intended locations. More research on ice management technologies could be used to extend the drilling season. Also, additional scientific/engineering studies for ice scour protection of permanent subsea wells would benefit the industry.

## **Summary**

The primary method to prevent a hydrocarbon spill is prevention and prudent well design. After the Macondo incident in 2010, the industry and government significantly upgraded the regulations and standards with respect to well integrity and well control. Operators must follow a strict set of controls that require extensive verification, testing, and certification of well control equipment, well designs, and barriers to the flow of hydrocarbons. In U.S. federal waters, there is ample regulation to ensure that operators and rig owners follow prudent practices. Furthermore the API has numerous documents that specify the equipment and procedures for well integrity and for rigorous drilling practices. In the highly

unlikely event that all of the normal barriers fail during a drilling operation, the industry has developed subsea shut-in devices and capping stacks designed to be capable of securing the well from the flow of hydrocarbons.

Multiple spill prevention measures and barriers are currently designed into the wells, and these barriers are defined and specified in API/ISO standards and U.S. offshore regulations. Drilling fluid, casing design, cement, and other well components are the primary barriers and the blowout preventers (multiple redundancies) are the secondary barrier to prevent a release to the external environment.

Industry is seeking an alternative to a same season relief well for the U.S. Arctic:

- To stop the flow and secure the well in the fastest possible time thus minimizing the associated environmental impact
- To safely extend the drilling season to support economic drilling operations.

The decision to use a capping stack or prepositioned device for capping is based on an analysis of the well and environmental conditions. If ice conditions, water depth, and/or anticipated well conditions or combinations of these would complicate well capping, then a prepositioned device may be the most efficient option. Industry continues to develop/deploy technology in this area such as the Shell Arctic Capping Stack, Chevron Alternative Well Kill System, and the Kara Sea Enhanced Subsea Shut-in Device.

In summary, the industry's primary approach to loss of well control is prevention, which is achieved through adherence to operations integrity management systems combined with a culture of safety and risk management. Wells can be drilled safely and well control can be maintained when:

- Focus remains on safe operations and risk management
- Wells are designed for the range of risk anticipated
- Equipment has the required redundancy and is properly inspected and maintained
- Personnel are trained; tests and drills are conducted
- Established procedures are followed.

## **OIL SPILL RESPONSE OVERVIEW AND BACKGROUND**

### **Introduction and Background**

Robust oil spill response (OSR) capabilities, in both open water and in the presence of ice, are critically important for oil and gas exploration and production in U.S. Arctic waters. Industry has conducted research on oil spill response for cold regions for many decades. Further, the oil and gas industry has implemented OSR contingency plans for exploration and production activities for multiple projects in ice-prone regions. Even though these previous activities form a basis for OSR planning as oil industry activities further advance into the offshore Arctic, there is a need to continue to develop the capabilities and understand the limitations of existing and evolving OSR technology.

The presence of sea ice, the associated cold temperatures, and darkness are key features that separate Arctic spill response from any other. It is worth highlighting that one significant advantage that ice cover provides is time. Rapid response is critical to spills in open water because of the dynamic nature of marine spills—oil slicks can rapidly spread to become extremely thin, break into many small slicks, and strand on shorelines. The outcome of a spill in open water is often determined within a matter of hours, allowing very little time to consider key decisions. In contrast, the presence of a significant ice cover (60% or more) can significantly slow the spreading rate and contain oil in relatively small areas, giving responders added time to develop and implement effective response strategies, partly offsetting challenges caused by Arctic remoteness and harsh conditions.

Responding to an oil spill is challenging under any circumstance. Arctic conditions introduce additional operational considerations, both positive and negative. These challenges include:

- The dynamic nature and unpredictability of the ice cover.
- Darkness and periods of limited visibility during the winter months.
- Remoteness and great distances that are often involved in responding over vast ocean areas.

- Effect of cold temperatures, ice, and a harsh operating environment on response personnel and equipment.
- Lack of shore-based infrastructure and communications to support and sustain a response of any significant magnitude.<sup>22</sup>
- Presence of ice, which generally limits or prevents the effective use of traditional mechanical cleanup methods in responding to large spills.
- Difficulty in finding and accessing oil trapped on or under moving ice offshore.
- Lack of oil spreading within slush and brash-filled leads and openings in the pack ice significantly decreases oil flow to the skimmer, and along with freezing of pumps, fittings, and hoses, makes skimming operations extremely difficult.
- Potential gelling of crude oils with pour points at or below 0°C.
- Lack of ports or approved disposal sites severely limit the ability to deal with large volumes of recovered oily waste.
- The general lack of infrastructure requiring that operators be entirely self-sufficient in their ability to support an extended response operation.

Whereas, operational benefits of Arctic conditions include:

- Reduced rate and extent of spreading in many situations, which increases time for response, keeps oil thick, and often extends the time window for certain response options (further discussion follows).
- The presence of ice in the form of floes reduces wave action and ice and snow slows weathering (slower evaporation and lower emulsification rates) reducing emulsification and thereby extending the windows of opportunity for burning and dispersant application.<sup>23</sup>
- Extended daylight for part of the year increases the operational time for response activities.
- Growing ice can potentially encapsulate and isolate oil from the marine environment for many months providing additional time for planning and executing a response.
- The fresh condition of encapsulated oil when exposed at a later date (e.g., through ice manage-

ment or natural migration/melt) enhances the chances for effective combustion and/or dispersion.

- When ice concentrations preclude the effective use of traditional containment booms, the ice itself often serves as a natural barrier to the spread of oil. The natural containment of wind-herded oil against ice edges leads to thicker oil films that enhance the effectiveness of burning.
- The movement of individual ice floes in intermediate ice concentrations can increase the available natural mixing energy and promote successful dispersion in the leads between floes.
- The fringe of landfast ice common to most Arctic shorelines acts as an impermeable barrier and prevents oil spilled offshore from reaching coastal areas throughout the long winter period.

## State of Knowledge and Response Options

Over the past four decades, the oil and gas industry and federal government have made significant advances in being able to detect, contain, and clean up spills in Arctic environments. Many of these advances were achieved through collaborative research programs with a mix of industry and government partners (notably the Minerals Management Service [MMS], the predecessor to the current BSEE). The broad range of international oil in ice research carried out in the United States, Canada, Norway, and the Baltic states since the early 1970s is summarized in Dickins and Fleet,<sup>24</sup> Fingas and Hollebone,<sup>25</sup> Dickins and Buist,<sup>26</sup> SL Ross et al.,<sup>27</sup> and Potter et al.<sup>28</sup> Much of the knowledge base on oil in ice behavior and Arctic spill response draws on experiences with a number of field experiments (summarized in Dickins<sup>29</sup> and discussed below).

Over the past 5 years, large-scale international research efforts have focused on improving industry's capability to deal with future spills in Arctic waters. Notably, the SINTEF Oil in Ice JIP advanced knowledge in many important areas, including the use of firebooms, herding agents, in-situ burning, dispersants, and skimmers in ice-covered waters.<sup>30</sup> Lessons learned in that program are now being applied to a broad suite of research projects initiated as part of the ongoing Arctic Oil Spill Response Technology Joint Industry Programme.<sup>31</sup>

Recent key sources that review the operational and technical aspects of Arctic spill response options include SL Ross et al.,<sup>32</sup> Potter et al.,<sup>33</sup> and NRC.<sup>34</sup>

Basic response strategies for spills in open water, adopted for an ice environment, use the same general suite of countermeasures used elsewhere in the world, including:

- Mechanical containment and recovery with booms and skimmers in open water and very open pack ice and skimmers extended from vessels directly into trapped oil pockets in heavier ice
- Dispersants applied to surface slicks or applied sub-sea for a continuous release to transfer oil into the water column as small droplets that increases the overall oil surface area to enhance biodegradation
- A combination of strategies to concentrate the oil and burn it in situ; in an Arctic environment, these can involve containment against natural ice edges without booms, fire resistant booms in open water or very open drift ice, and herding agents to thicken oil in open water and intermediate ice concentrations.
- Detection and monitoring while potentially planning a later response (e.g., burning on ice in the spring)
- Natural attenuation through evaporation and dispersion (i.e., no active response)

The following provides a brief overview of the understanding of these response options.

## **Mechanical Containment and Recovery**

Potter et al. define “containment and recovery or C&R” as actions taken to remove oil from the surface of water by containing the oil in a boom and/or recovering the oil with a skimming or direct suction device or sorbent material.<sup>35</sup> The latter two options are unlikely to be used to any great extent offshore in the presence of ice.

Containment and Recovery is generally regarded as the preferred response strategy for responding to marine oil spills in open water and is mandated as the primary technique in many jurisdictions through legislative action (e.g., Alaska). Stakeholders in many countries favor containment and recovery over other oil spill countermeasures because it is viewed

as directly removing oil from the marine environment. However, there are significant operational and practical limitations to solely relying on mechanical containment and recovery systems for large spills at sea in most parts of the world, and these limitations become even more critical in the Arctic.

Sea state is always an important consideration for mechanical recovery where booms are required for containment in open water and areas with very open drift ice (1-3/10). Oil is often entrained beneath or splashed over booms in short-period wind waves exceeding 3-5 feet. Increasing wave heights also make equipment deployment/retrieval difficult, reduce the effectiveness of skimmers, and may result in unsafe working conditions. While any significant ice cover will effectively damp the wave energy, it is still possible to encounter severe sea states near the ice edge in a marginal ice zone with widely dispersed ice floes. This limitation also applies to the use of fire resistant booms in open water or light ice cover.

In any large spill in open water or light ice cover, the oil usually spreads rapidly to form a very thin layer on the water surface, much less than 1 mm, before booms can be deployed. Substantial lengths (miles) of containment boom managed by a number of vessels are then required to concentrate these thin oil slicks for recovery. The rate at which a single skimming system encounters the slick moving at typically less than 1 knot forward speed is the key limiting factor controlling the total volume of oil that can be practically recovered. In addition, high-capacity skimmers used in this application often recover significant quantities of water along with the oil. Emulsification can substantially increase the volume of oily liquid (by several times or more), resulting in very large offshore storage demands and on-land disposal requirements with associated long-term environmental impacts. These issues are especially problematic in the U.S. Arctic with no deep-draft ports to provide marine access to shore and few, if any, approved disposal sites.

The constraints of operating in a remote Arctic area make mounting or sustaining a massive on-water mechanical response, such as that employed in the Gulf of Mexico in 2010, unworkable. Under relatively favorable sea conditions (compared with many other worldwide offshore oil producing regions) and with almost unlimited marine resources and coastal infrastructure, mechanical recovery operations in

the Macondo response only accounted for an estimated 2 to 4% of the oil volume discharged.<sup>36</sup> One component of this disappointing performance could have been related to the lack of sufficient surveillance and spotting aircraft available to direct the mechanical teams to the thickest and most homogeneous expanses of thick oil, which placed other strategies, such as dispersants and in-situ burn, in areas with thicker oil. However, these low numbers are also a reflection of the inherent inefficiencies associated with booming extremely thin oil slicks (average <1 mm) and decanting and transferring recovered oil/emulsion to backup storage. The performance of the mechanical recovery teams looks somewhat better when calculated as a fraction of oil available on the surface, as opposed to the total volume released, but the overall recovery was still well below 10%, in keeping with many past experiences involving large widespread spills at sea.

Reliance on mechanical recovery becomes even more problematic in the presence of ice where the oil encounter rate is further reduced. Relatively small amounts of drift ice (as little as 10% coverage) can interfere greatly with the flow of oil to the skimmers and result in recovery rates far below a skimmer's theoretical capacity.<sup>37,38,39</sup> Considering the operational constraints outlined above and the basic ineffectiveness of mechanical recovery in dealing with a large spill, any future response to a large offshore Arctic spill should not rely primarily upon containment and recovery.<sup>40,41</sup>

Mechanical recovery is still considered a first line of defense and plays an important role in dealing with smaller spills contained by ice. In the Baltic Sea for example, a number of oil spills in winter shipping lanes have been successfully recovered with brush/bucket skimmers.<sup>42,43</sup> In 2011, Norwegian responders recovered 50% of 112 cubic meters of heavy fuel oil spilled into freezing waters of Oslo fjord from the Godafoss.<sup>44</sup>

## Dispersants

Dispersants are an important response option that should be considered for Arctic contingency planning because they can treat significant volumes of oil very rapidly by delivery via aircraft. Also, subsea dispersant injection enables a meaningful response to worst-case drilling scenarios while the oil is at the concentrated sources.

Dispersants are designed to enhance natural dispersion by reducing the surface tension at the oil/water interface, making it easier for waves to create small oil droplets (generally less than 100 microns) that remain in suspension for long periods and are rapidly diluted in the water column to below acute toxicity thresholds. Naturally available levels of nutrients can sustain effective microbial degradation, in Arctic as well as temperate waters.<sup>45</sup>

There has been considerable debate over the effectiveness of dispersants on crude oil degradation at low seawater temperatures. Over the past two decades, a series of tank and basin tests and field experiments have proven that oil can be dispersed successfully in cold ice covered waters.<sup>46,47,48,49,50</sup> Research shows that dispersants are effective on unemulsified oil at freezing temperatures as long as viscosity does not increase significantly and the oil remains a liquid well above its pour point.<sup>51</sup> New dispersant gel formulations promise increased effectiveness on cold viscous oils with longer windows of opportunity.<sup>52</sup>

There is still considerable debate on the rate and extent of oil biodegradation in Arctic waters. Recent studies in a laboratory at Point Barrow, Alaska, demonstrated that indigenous Arctic microorganisms effectively degraded both fresh and weathered oil. The same project also studied oil and dispersed oil toxicity to Arctic organisms. Juvenile Arctic cod, juvenile Arctic sculpin, and an Arctic copepod and their counterparts in southern waters exhibited similar tolerance to dispersed oil, and the use of dispersant was not observed to increase the toxicity of the oil.<sup>53</sup>

The SINTEF Oil in Ice JIP demonstrated the effectiveness of dispersants in a range of ice conditions in mesoscale basin tests and field trials. As part of that project, a new controllable applicator arm was developed to deliver dispersant more effectively to isolated oil pockets in the ice.<sup>54</sup> Vessel propellers or thrusters can be used to overcome the lack of turbulent mixing energy in scenarios involving significant ice cover and minimal wave action.<sup>55,56</sup> Dispersion of oil at low temperatures in the presence of ice can also be enhanced with the addition of mineral fines under turbulent mixing conditions provided by propeller wash.<sup>57</sup>

The Macondo response demonstrated that large-scale subsea dispersant injection is potentially a very effective response measure to mitigate the effects of

a subsea wellhead blowout in both temperate and Arctic waters. A major benefit of direct subsea dispersant injection is the ability to continuously respond without being affected by darkness, extreme temperatures, strong winds, rough seas, or the presence of ice. Because of the high efficiency associated with adding dispersant directly to fresh oil at the discharge point under highly turbulent conditions, the dispersant volume can be substantially less (five times or more) than a surface application, which is a key advantage given the long and difficult logistics resupply chain in most Arctic areas.<sup>58,59</sup> Information resulting from the Macondo oil spill, ongoing research on the technique, and relevant data from surface use of dispersants can be used to support the use of subsea dispersant injection in the future. However, more work could be done to further understand the effectiveness, systems design, and short- and long-term impacts of subsea dispersant delivery.<sup>60</sup>

## Controlled In-Situ Burning

In-situ burning (ISB) in ice and Arctic environments is a safe, environmentally acceptable, and fully proven technique with numerous successful Arctic field validations over the past 40 years.<sup>61,62,63,64,65,66</sup> ISB is especially suited for use in the Arctic where ice often provides a natural barrier to maintain the necessary oil thicknesses for ignition without the need for containment booms and oil remains fresh and unemulsified for a longer period of time.

Numerous agencies, primarily in the United States, have established guidelines for the safe implementation of ISB as a countermeasure. The U.S. National Institute of Standards and Technology, National Oceanographic and Atmospheric Administration (NOAA), and Environment Canada have computer models used to predict safe distances for downwind smoke concentrations and eliminate any risk to responders or local populations. In 1994, the Alaska Regional Response Team incorporated ISB guidelines for Alaska into its Unified Response Plan, becoming the first Arctic area to formally consider ISB as an oil spill countermeasure.<sup>67</sup> Their guidelines are considered the most fully developed to date and contain safe distances for responders and the public under different conditions.<sup>68</sup>

Experience with burning fresh, weathered, and emulsified oils and petroleum products in a range of

ice conditions has led to some basic rules of thumb. The most important parameter is the oil thickness. In order to achieve 60 to 80% removal efficiency in most situations, the starting thickness of crude oil needs to be on the order of 3 to 5 mm.<sup>69</sup> While this thickness may not always occur naturally, the required thickness for successful ignition and burning may occur through wind herding against ice edges, use of fire-proof booms, and the use of herding agents.

In Arctic field tests, burn removal rates have ranged from 65% to well over 90%, depending mainly on the size distribution of the melt pools on ice. In an experimental spill under solid ice in Norway, 3,400 liters of crude oil were allowed to surface naturally through the ice as it warmed in the spring and then burned with an overall removal efficiency of 96%. A portion of this oil was exposed to weathering on the ice surface for more than 1 month before being successfully ignited.<sup>70</sup>

Despite highly successful test results more than four decades, there is continued concern by some drawing conclusions that actual spill conditions could reduce the effectiveness of ISB to far below these theoretical maximums.<sup>71,72</sup> In practice, experiences with very large burns at sea have demonstrated that efficiencies increase with scale, as the oil is pulled into the burn area by thermally induced strong radial air inflow at the surface.<sup>73,74</sup> Similar high efficiencies were documented for ISB of oil mixed with ice within fire-resistant booms during the 2009 SINTEF Oil in Ice Field Experiments.<sup>75</sup> In the same project, oil that was allowed to drift and weather in very close pack ice for over a week was also successfully ignited and burned.<sup>76</sup>

ISB was first used successfully offshore on a trial basis during the *Exxon Valdez* response.<sup>77</sup> In 1993, a U.S.-Canada experiment off Newfoundland successfully burned crude oil in fire-resistant booms in the open ocean and monitored a large suite of environmental parameters, including smoke composition (carcinogens, PAH, etc.), residue toxicity, and upper water column impacts.<sup>78</sup> Results demonstrated that when conducted in accord with established guidelines, ISB is safe and poses no unacceptable risk to human populations, wildlife, or responders.

Most recently, the massive ISB operation in response to the Macondo blowout provided a unique set of full-scale operational data applicable to response

planning for Arctic offshore areas in the summer. In the first operational, sustained use of ISB offshore on a large scale, approximately 400 controlled burns removed an estimated 220,000 to 310,000 barrels of oil from the Gulf of Mexico. Other than a single burn conducted with fire boom during the *Exxon Valdez* spill, this was the first large-scale application of controlled burning in an operational setting.<sup>79</sup>

With aerial ignition systems such as the Heli-torch™, multiple oiled pools on the ice in the spring can be ignited quickly over a wide area. Future research is aimed at developing more efficient, high-speed aerial ignitor systems with larger payloads that could reach spills further offshore.<sup>80</sup>

The concept of using herding agents to burn free-drifting oil slicks in open water or very open pack ice was successfully field tested for the first time in the Norwegian Barents Sea in 2008 as part of a JIP on Oil Spill Contingency for Arctic and Ice-Covered Waters.<sup>81</sup> Burn removal effectiveness in that test was estimated to be on the order of 90%. The residue floated readily and was recovered manually from the water surface and ice edges. Buist et al. summarizes past research into herders and concludes that oil spill responders should consider utilizing them to enhance ISB in light to medium ice concentrations.<sup>82</sup>

A new ISB project planned under the Arctic Response Technology JIP includes the validation and testing of aerial application systems for herders using both manned and remote-controlled helicopters. The JIP is also initiating a new project (2014/15) to evaluate the potential of herders under different oil properties and weathering, as well as investigating windows of opportunity for their use. The JIP recently published a comprehensive state of knowledge review of in-situ burning in the Arctic, including all known references.<sup>83</sup>

## Detection, Delineation, and Tracking

To mount an effective response using any one of the three main countermeasures, it is critical to know not only where spilled oil is at any given time but also the distribution of film thickness. Valuable airborne and marine resources need to focus on the treatment of the thickest oil patches. This requires accurate, near real-time reconnaissance presented in a map product that is immediately useable by responders

in the field and decision-makers in the Unified Command, as the joint interagency/industry response management effort is often referred to.

Finding and mapping oil in open water is far from straightforward, as Leifer et al. discuss from the Macondo experience.<sup>84</sup> In the Arctic, false positives are potentially a critical issue in reliably spotting oil mixed with a range of ice types. Many sensors are negatively impacted by blowing snow, low cloud, fog, and darkness that characterize the Arctic offshore for much of the year.

Detection is generally not ambiguous in the case of a large visible spill around a vessel or around a fixed drilling platform (an exception might be a subsea pipeline leak under ice). However, continued monitoring and tracking of oiled ice as it moves away from the original discharge point presents a significant challenge with existing sensors and systems. Fortunately, the tracking aspect of this requirement is already covered by proven technology in the form of specialized GPS beacons designed to survive over long time periods in drifting ice. By deploying these beacons at closely spaced intervals from a continuous discharge site, responders can prepare to mount an in-situ burning exercise along a known track when the oil surfaces through the ice in the spring.

Dickins and Andersen summarized the state of the art for remote sensing of oil in ice in these points:<sup>85</sup>

- A mix of conventional airborne sensors is likely to prove effective with spills in relatively open ice cover (1-4/10) where there is a distinct oil slick covering areas of square kilometers or more—analogue to open water with some ice present.
- The use of remote sensing to detect spills contained in closely packed ice is still uncertain, requiring all weather, high-resolution capabilities that have yet to be properly tested in a field situation.
- The lack of significant waves in the presence of ice complicates the use of marine or satellite radar systems, both of which depend on differences in surface waves, with and without the presence of oil on the water surface, as a means of detecting the presence of oil.
- The detection of oil underneath and within the ice remains a major challenge. Recent promising developments in this area include the use of

ground penetrating radar from above and sonar from beneath the ice.<sup>86,87,88</sup> In addition efforts are ongoing to explore the potential of Nuclear Magnetic Resonance for detecting oil in ice.<sup>89</sup>

- Future platforms will likely involve both unmanned aerial vehicles (UAVs) and autonomous underwater vehicles (AUVs) carrying a suite of sensors.

A remaining technical constraint concern that is being worked through JIPs is the ability to detect and map oil on, in, or under ice at a tactical scale in darkness and low visibility over a range of scenarios and ice conditions.

## Synopsis

There is an extensive background of knowledge regarding oil spill behavior in Arctic conditions as well as the effectiveness and applicability of different response strategies in ice and cold water. While technology enhancements will continue to improve the operability and effectiveness of different response systems in ice, there is an ongoing challenge associated with informing and educating a diverse set of stakeholder groups, residents and regulators. The overall goal is to gain acceptance that all response options, including burning and dispersants, need to be available for responders to use on short notice as the spill behavior and environmental conditions dictate. Any such decisions to employ a particular strategy need to be contingent on demonstrating a positive net environmental benefit.

There needs to be a more balanced perspective regarding the full range of available response techniques, including controlled burning and the application of dispersants. All stakeholders must be informed of the benefits, limitations, and trade-offs associated with these techniques, and be provided the information to understand that even under the best of conditions, one can never expect to recover or eliminate all of the oil spilled. Federal and state planning standards and regulations need to be reviewed to address realistic operational and environmental constraints, as well as practical levels of response capability. The type and number of resources that can be maintained and operated safely and effectively for a given area, project, or facility should reflect a careful assessment of the most probable spill events that might occur, while recognizing that backup resources can be cas-

aded within a short period of time to support a more serious spill event.

## SUMMARY OF CURRENT OIL SPILL RESPONSE RESEARCH PROJECTS

### Introduction and Background

A large amount of scientific research and testing has been conducted in the past 50 years to improve equipment and methodologies available to respond to an oil spill in Arctic conditions. Recent examples include the SINTEF Oil in Ice Joint Industry Project (JIP) in 2006-2009 (<http://www.sintef.no/Projectweb/JIP-Oil-In-Ice/Publications>) and research sponsored by the Bureau of Safety and Environmental Enforcement (<http://www.bsee.gov/Technology-and-Research/Oil-Spill-Response-Research/index/>).

Much of the industry-sponsored research is published in proceedings of oil spill conferences such as the International Oil Spill Conference (available online at <http://ioscproceedings.org/>), Inter-Spill, and the Arctic and Marine Oilspill Program technical seminar. Databases of papers and reports describing some of the past research projects are also available:

- U.S. Arctic Research Commission ([http://www.Arctic.gov/publications/white%20papers/oil\\_spills\\_tableA.pdf](http://www.Arctic.gov/publications/white%20papers/oil_spills_tableA.pdf))
- Interagency Coordinating Committee for Oil Pollution Research (<http://www.uscg.mil/iccopr/>)
- University of New Hampshire Coastal Response Research Center ([http://crrc.unh.edu/center-funded-projects#Dispersant\\_Initiative\\_Projects](http://crrc.unh.edu/center-funded-projects#Dispersant_Initiative_Projects))
- Louisiana Universities Marine Consortium (LUMCON) (<http://www.lumcon.edu/library/dispersants/Default.asp?action=search>)
- Prince William Sound Regional Citizens Action Committee (<http://www.pwsrccac.org/programs/environmental-monitoring/dispersants/dispersant-literature-reviews/>)

Advances continue to be made in detection, containment, and cleanup of oil spills in Arctic environments.<sup>90</sup> To develop the present capability, experts from industry, government agencies, academia, and independent research organizations have completed hundreds of scientific and analytical studies at the lab, basin, and field scale in the United States, Canada, and

Scandinavia.<sup>91,92,93,94,95,96,97</sup> This sustained and frequently collaborative effort is not commonly known and recognized by those outside the field of oil spill response.

These 50 years of research form a basis for OSR contingency planning in the Arctic today and should be used to inform current and future research on Arctic oil spill response. The goal of this section is to describe ongoing research and development on Arctic oil spill response.

## Ongoing Industry-Sponsored R&D Projects

### Arctic Response Technology Joint Industry Programme

The Arctic Response Technology Joint Industry Programme (JIP) was initiated in 2012 and is currently ongoing. It represents a collaboration of nine international oil and gas companies (BP, Chevron, ConocoPhillips, Eni, ExxonMobil, North Caspian Operating Company, Shell, Statoil, and Total) that have come together to further enhance industry knowledge and capabilities in the area of Arctic spill response as well as to increase understanding of potential impacts of oil on the Arctic marine environment. The JIP focuses on all aspects of Arctic oil spill response and has 10 specific projects:

- **Project 1 – Fate of Dispersed Oil under Ice:** The project will first collect under ice turbulence data and then use this data to develop a numerical model that can predict the resurfacing potential of dispersed oil that might move under an ice field. The model predictions will provide important information for dispersant use in ice-covered marine environments and support contingency planning.
- **Project 2 – Dispersant Testing under Realistic Conditions:** The project includes a series of ice-basin tests to define some of the operational criteria for use of dispersant and mineral fines in Arctic marine waters. Parameters to be studied are oil type, oil viscosity, ice cover (type and concentration), air temperature, and mixing energy (natural, water jet, and propeller wash). Another objective is to identify the regulatory requirements and permitting process for dispersant and mineral fines use for each Arctic nation/region.

- **Project 3 – Environmental Impacts from Arctic Oil Spills and Oil Spill Response Technologies:** The project will improve the knowledge base for using Net Environmental Benefit Analysis (NEBA) for response decision-making and ultimately facilitate stakeholder acceptance of the role of environmental impact assessment in OSR plans and operations.
- **Project 4 – Oil Spill Trajectory Modeling in Ice:** The project will advance the oil spill modeling for oil spills in ice-affected waters by evaluating ice trajectory modeling approaches and integrating the results into established industry oil spill trajectory models.
- **Project 5 – Oil Spill Detection and Mapping in Low Visibility and Ice:** The project will expand remote sensing and monitoring capabilities in darkness and low visibility, in pack ice, and under ice. This project is split into two elements: surface remote sensing (i.e., satellite-borne, airborne, ship-borne, and on-ice detection technologies) and subsea remote sensing (i.e., mobile-ROV- or AUV-based and fixed detection technologies).
- **Project 6 – Mechanical Recovery of Oil in Ice:** The project will evaluate innovative ideas for improving efficiency of mechanical recovery equipment in Arctic conditions.
- **Project 7 – In-Situ Burning of Oil in Ice-Affected Waters. State of Knowledge:** The project will prepare educational materials to raise the awareness of industry, regulators, and external stakeholders of the significant body of knowledge that currently exists on all aspects of ISB. The materials are also intended to inform specialists and stakeholders interested in operational, environmental, and technological details of the ISB response technique.
- **Project 8 – Aerial Ignition Systems for In-Situ Burning:** The project will develop improved ignition systems to facilitate the use of in-situ burning in offshore Arctic environments, including when the presence of sea ice restricts use of vessels as a platform for this response option.
- **Project 9 – Chemical Herders and In-Situ Burning:** The project will advance the knowledge of chemical herder fate, effects, and performance to expand the operational utility of in-situ burning in open water and in ice-affected waters.
- **Project 10 – Field Research:** Results from previous research projects show that many of the advances in our state of knowledge about Arctic response technology were gained through controlled field

experiments with oil. This project will pursue opportunities for large-scale releases for validation of response technologies and strategies.

This JIP has brought together the world's foremost experts on oil spill response research, development, and operations from across industry, academia, and independent research centers to undertake the technical work and scientific studies. All research projects are being conducted using modern protocols and proven scientific technologies. Research integrity is ensured through technical peer review and public dissemination of results. Detailed information on the JIP is available online at <http://www.arcticresponsetechnology.org>.

### **Arctic Dispersed Oil Fate and Effects JIP**

Building on the results of the recently completed NewFields JIP that was initiated by Shell,<sup>98,99</sup> which evaluated toxicity and biodegradation of physically and chemically dispersed Alaska North Slope oil under Arctic conditions in the Beaufort and Chukchi Seas, the University of Alaska Fairbanks continues evaluation of oil biodegradation in the Arctic marine environment. This project aims to identify microorganisms and genes that are responsible for hydrocarbon biodegradation, evaluate their background levels in the environment and how these levels change in response to presence of hydrocarbons.<sup>100</sup> This new JIP is supported by Shell, ConocoPhillips, ExxonMobil, Statoil, BP, Alaska Clean Seas, and the Oil Spill Recovery Institute.

### **Alaska Clean Seas Research**

Alaska Clean Seas (ACS) provides response services to the Alaska North Slope Crude Oil Producers and the first 167 miles of the Trans-Alaska Pipeline System. ACS has maintained an active oil spill research and development program since the early 1980s (<http://www.alaskacleanseas.org/>). The program focuses on spill response and wildlife management in Arctic conditions. Currently funded (and cofunded) projects include:

- A study conducted in Germany on remote sensing techniques for locating oil under ice<sup>101</sup>
- Biodegradation research at the University of Alaska Fairbanks
- Development of Arctic marine mammal response capabilities in coordination with NOAA National

Marine Fisheries, U.S. Fish and Wildlife, the Alaska Zoo, and Alaska SeaLife Center

- Participation in the mechanical recovery work stream of the Arctic Oil Spill Response Technology JIP.

### **Remote Sensing and Dispersant Research**

ExxonMobil Upstream Research Company has an ongoing research and development program on Arctic and cold weather oil spill response mostly focused on remote sensing and enhanced oil spill response techniques. Ongoing projects include:

- Developing a technique to use Nuclear Magnetic Resonance (NMR) for detection of oil trapped in and under ice. NMR uses the Earth's magnetic field to differentiate the subtle differences of hydrogen protons in water and oil.<sup>102</sup>
- Developing a new dispersant "gel" for treating more viscous oils in cold marine environments.<sup>103</sup> The gel-like consistency allows for greater encounter time with the viscous oil allowing the dispersant time to break down the oil into biodegradable droplets.
- Developing a technique to use the prop wash of icebreakers to promote dispersion of oil slicks in ice for situations where natural mixing energy is insufficient.<sup>104</sup>

### **American Petroleum Institute Research**

In 2011 the American Petroleum Institute initiated a 4-year research and development Joint Industry Program (API JIP) that includes a broad range of oil spill response research topics. One area particularly relevant to the Arctic is research on subsea dispersant injection. Subsea dispersant injection is an OSR technique where dispersants are applied directly to a jet of oil that might be released from a subsea well. Subsea dispersant injection could be a key OSR contingency planning tool applicable to what is often determined to be the worst-case discharge—i.e., loss of well control. Subsea injection of dispersants offers significant benefits compared to the application of dispersants on the sea surface. For example, it:

- Reduces the amount of oil coming to the surface to protect personnel at the surface from volatile components of the oil

- Requires much less dispersant because it is injected directly into a turbulent jet of fresh oil
- Proceeds day and night under a wide range of weather conditions
- Potentially treats all oil escaping from a single release point
- Rapidly dilutes the oil into a large water mass to decrease the concentration of dispersed oil (1) below acute toxicity thresholds and (2) to levels that allow aerobic biodegradation.

The API subsea dispersant injection project scope includes research on application methods, effectiveness, plume modeling, monitoring techniques, and potential environmental effects of oil dispersed subsea (<http://www.api.org/environment-health-and-safety/clean-water/oil-spill-prevention-and-response/api-jitf-subsea-dispersant-injection-newsletter>).<sup>105</sup> While this work is not specifically Arctic-focused, many of its findings will be applicable to Arctic regions.

### **Research Activities in Europe and Scandinavia**

Finnish and Norwegian scientists have historically conducted research on Arctic and cold-weather response techniques. This work continues with the development of new ice-capable oil spill recovery vessels by Aker Arctic,<sup>106</sup> development of high-capacity Arctic skimmers by OSR equipment manufacturers, as well as the work of the Finnish Environmental Institute. A team of international researchers recently evaluated sensors for detecting oil under sea.<sup>107</sup> Some other projects conducted in Norway for sub-Arctic conditions include the SYMBIOSES model that can assist with Net Environmental Benefit Analysis of response options (<http://www.symbioses.no/>) and a JIP evaluating environmental impacts and response options in coastal environments. The Norwegian Clean Seas Association for Operating Companies (<http://www.nofo.no/en/>) has sponsored research focused on sub-Arctic oil spill response for years. This program also includes yearly offshore exercises and tests with real oil. With increasing interest to Arctic operations this program will likely add oil in ice projects to its portfolio.

### **Ongoing R&D Projects Sponsored by Nonprofit Organizations**

The Oil Spill Recovery Institute (OSRI) was established by the U.S. Congress in response to the 1989 *Valdez* oil spill. Its mandate is to support research,

education, and demonstration projects designed to respond to and understand the effects of oil spills in the Arctic and sub-Arctic marine environments <http://www.pws-osri.org>. Over the years OSRI has funded numerous projects on Arctic spill response and evaluation of environmental impacts. Among currently funded projects is an evaluation of an aerostat system for oil spill remote sensing, provision of oil spill drifter buoys for the USCG oil spill field exercise, evaluation of sonar's ability to detect oil in and under ice, and support for biodegradation research at the University of Alaska Fairbanks.

### **Ongoing R&D Projects Sponsored by Governmental Organizations**

#### ***Bureau of Safety and Environmental Enforcement Sponsored Research***

For three decades, the BSEE (formerly MMS) has been the principal U.S. federal agency funding oil spill response research, including Arctic-relevant research. Achievements of the program were described in a 2008 U.S. Department of the Interior Minerals Management Service report.<sup>108</sup> The BSEE research program is addressing oil spill research needs on two levels—first by sponsoring direct applied research and second by maintaining the National Oil Spill Response Test Facility in Leonardo, New Jersey (Ohmsett). Ohmsett is not only a vital component of the BSEE oil spill research, it is also a national asset where government agencies, private industry, and academia can conduct full-scale oil spill research and development programs and training in a controlled environment with real oil. BSEE has also funded NOAA for R&D in two primary areas: modeling and data collection/dissemination.

Description of the ongoing projects and reports from the completed projects are available at <http://www.bsee.gov/Technology-and-Research/Oil-Spill-Response-Research/index/>. Some of the currently funded projects on Arctic OSR include testing of skimmer hoses and hose couplings under simulated Arctic conditions; development of surrogate ice modules for simulated Arctic environment testing; technological assessment of Alaskan Arctic oil spill response temporary oil storage options; hosting an Ohmsett “Ice Month” for evaluation of oil recovery systems in ice conditions; participation in the National Research Council study on Arctic OSR ([http://www.nap.edu/catalog.php?record\\_id=18625](http://www.nap.edu/catalog.php?record_id=18625)); research to support

the prediction of effectiveness of dispersant use in the U.S. Beaufort and Chukchi Seas; dispersant effectiveness comparative testing in a simulated Arctic environment; enhanced oil spill detection sensors in low-light environments; oil spill detection and mapping under Arctic sea ice using autonomous underwater vehicles; and burning behavior of oil in ice channels.

BSEE has also funded NOAA for R&D in two primary areas: modeling and data collection/dissemination. For modeling, BSEE has provided support to improving oil spill trajectory forecasting for response to spills in icy waters. Modeling improvements will include shallow water well blowout algorithms and physiochemical fate of oil spilled on or under ice. For data collection/dissemination, BSEE has supported the Environmental Response Management Application (ERMA) in the coordination of Arctic data from government, academic, and traditional knowledge sources.

### ***National Oceanographic and Atmospheric Administration Sponsored Research***

NOAA is involved in a variety of research projects. The Coastal Response Research Center (CRRC) was established as a partnership between NOAA, through the Office of Response and Restoration, and the University of New Hampshire. Together, NOAA and CRRC continue to coordinate oil spill research by sponsoring and hosting several oil spill workshops on various topics including Arctic oil spill response and environmental impacts.

NOAA continues to develop the Arctic Environmental Response Management Application, which is a web-based GIS tool that integrates and synthesizes data into a single interactive map, providing a quick visualization of the response situation and improving communication and coordination among responders and environmental stakeholders.

NOAA is also currently developing an Arctic version of its oil spill trajectory model GNOME (General NOAA Operational Modeling Environment).

### ***U.S. Coast Guard Sponsored Research***

The U.S. Coast Guard Research and Development Center conducts a variety of oil spill response research. Their recent efforts include field deployments of response equipment in ice-covered waters in

the Great Lakes, and more recently the Arctic Shield exercises offshore Alaska.<sup>109</sup> The objective of the Arctic Shield exercises in 2012 and 2013 was to evaluate deployment of existing response equipment and new technologies that could enhance the efficiency of oil spill response in broken ice (i.e., ice that will not support personnel and equipment). Plans are to continue the Arctic Shield exercise in 2014. During the Arctic exercises several remote sensing techniques were tested including UAV, ROV, AUV, SWIFT (surface wave instrument float with tracking) buoys (for measuring turbulence), and an aerostat.

Other projects underway include development of an on-deck temporary storage system for Coast Guard buoy tenders, an ice management cage for skimmers, and a personal decontamination system for cold weather for use on small vessels of opportunity (fishing vessels and tug boats). The U.S. Coast Guard, through the Ship Structure Committee, is also conducting research on the effects of ice and ice-covered waters on ships and marine structures and their survivability in damaged conditions.

### ***Department of Energy's National Energy Technology Laboratory***

Building on Department of Energy's core competency in simulating and predicting the behavior of engineered-natural systems, National Energy Technology Laboratory (NETL) researchers are developing a new Gulf of Mexico (GOM) multicomponent model tying the subsurface, wellbore, and water column into a single integrated assessment modeling (IAM) tool. The final product, a coordinated platform (GOM IAM tool and EDXinsight), will utilize subsurface to shore datasets, which are being synthesized and integrated from a combination of existing data sources to allow new interpretations for the independent, rapid, and science-based prediction of ultra-deepwater hydrocarbon risks and potential impacts, that can be used to conduct predictive assessments of potential social, environmental, and production risk factors, and provide insight on future data and technology needs to support spill prevention. The tool may also serve as a rapid-response platform in the event of future spills or deleterious events. An interactive database of these data layers will be released through NETL's Energy Data Exchange ([www.edx.netl.doe.gov](http://www.edx.netl.doe.gov)); the link will also contain a report showing potential application of the tool to the Arctic (March 2015).

## ***Environmental Protection Agency Sponsored Research***

The U.S. Environmental Protection Agency is conducting tests of dispersants efficacy and toxicity at low temperatures.

### **Research by North American Academic Institutions**

The University of Alaska Fairbanks (UAF) conducted several Arctic oil spill projects in the past and now is building on existing technical expertise and leading the effort with University of Washington, Brigham Young University, and Rensselaer Polytechnic Institute to establish an Industry/University Cooperative Research Center for Arctic Sustainable Development. This center, if funded by the National Science Foundation, will begin a 5-year program with a focus on oil-spill related research and education.

UAF is also working with the Arctic Response Technology JIP to support large-scale testing of the in-situ burn project using herding agents (Project 9, described earlier in the section on the Arctic Response Technology Joint Industry Programme). This support includes managing construction of a 100 m x 100 m x 1 m deep ice-capable basin to allow a full-scale trial of herders with oil in ice, as well as in-situ burn tests.

Further, UAF is one of only six institutions in the U.S. to receive a Certificate of Authorization from the U.S. Federal Aviation Administration allowing them to conduct research on unmanned aerial vehicles. This positions UAF in a leadership role for development and testing of this tool for both environmental assessments and emergency response (including oil spill response).

The University of Manitoba in Canada is evaluating detection of oil in sea ice using various electromagnetic frequencies at the Sea Ice Environmental Research Facility. The focus of this project is on measuring dielectric permittivity in clean ice and in ice containing oil lenses using active microwave, passive microwave, sonar, and electromagnetic induction.

### **Conclusions**

The 50 years of completed research on oil spill response and oil spill fate and effects in Arctic and ice-prone regions provides a strong foundation for

oil spill contingency planning today. As with oil spill response in temperate environments, there will always be a need to advance capabilities and knowledge. The ongoing research described above continues this long-term effort. Further, there are many industry, consulting, academic, and government experts who were involved in much of the prior work. These individuals are a valuable resource that can support defining future research needs, contingency planning efforts, and rulemaking.

## **BEHAVIOR OF SPILLED OIL IN ICE**

### **Introduction**

Researchers have been studying the behavior of oil spilled into ice environments for over 40 years, and several landmark field experiments have been completed.<sup>110,111,112,113,114,115,116,117,118,119,120,121,122,123</sup> This research provides a strong basis for understanding how oil behaves in ice and how to develop strategies to safely respond to spills.

This section summarizes the results of this research. There are a number of reviews and assessments that provide more details on the behavior of oil spilled in Arctic environments.<sup>124,125,126,127</sup>

### **Oil in Ice-Covered Environments**

Currently, oil and gas activities in the Outer Continental Shelf will be mostly restricted to the open water and shoulder seasons that occur in the summer. During the open water season, oil will primarily behave as it would in temperate regions with the advantage of significantly more hours of daylight in which to conduct operations. The presence of ice, the harsh environmental conditions, and remoteness adds challenges to oil spill assessment and response in the Arctic. Ice cover and cold temperatures, however, may provide a critical advantage. Oil spill responders understand that speed is the key for a spill in open water. This is because of the very dynamic nature of oil on water. In contrast, cold temperatures and ice cover can keep oil thick, limit emulsification, and limit evaporation and dissolution. Oil evaporation, dissolution, and emulsification increase the viscosity of the oil generally making it more difficult to treat or recover. Further, landfast ice can protect shorelines from oil stranding for many months of the year. Thus, ice conditions may give response personnel more time

to respond counteracting some of the disadvantages caused by Arctic conditions and remoteness.

## Oil Weathering

The two most important weathering processes for oil spills are usually evaporation and emulsification because they increase oil viscosity making it more difficult to treat by all response options, and emulsification additionally increases the volume of the spill.

Oil behavior in any environment is strongly dependent on the oil properties. Light crude oils and condensates will have limited persistence because of their high volatility, solubility, and tendency to naturally disperse. Incorporation of oil into ice may increase the persistence of any of these oils, however.

Oil evaporation is a function of the slick thickness, oil temperature, and the amount of volatiles within the oil. Snow interacting with surface oil to eventually cover it will also reduce evaporation rates.

Ice dampens the mixing energy needed to generate oil-in-water emulsions. Thus, emulsification is not

expected to be as prevalent in ice-covered water. Further, natural dispersion will not be as significant.

Ultimately, weathering requires the oil to be exposed to either the air or water, or both. Oil trapped within ice is isolated from the water and air, which limits to a very large extent any weathering processes.

Another important factor governing the behavior of oil in the Arctic is the oil's pour point. Oil with a pour point above the freezing point of water will rapidly cool and gel to become a semisolid when spilled into an ice-covered environment. Because oil is shear thinning, oil subject to the motion of waves may not gel until it cools 10 to 15°F below its pour point.

## Oil Interaction with Ice

Figure 8-9 shows some of the possible configurations of oil in, on, and under ice. Even large spills of crude oil underneath solid or continuous ice cover will usually be contained within a relatively small area because of the rough undersides. If oil is trapped under ice in the winter, new ice will rapidly form under it even as late as May in the Arctic.<sup>128</sup> The

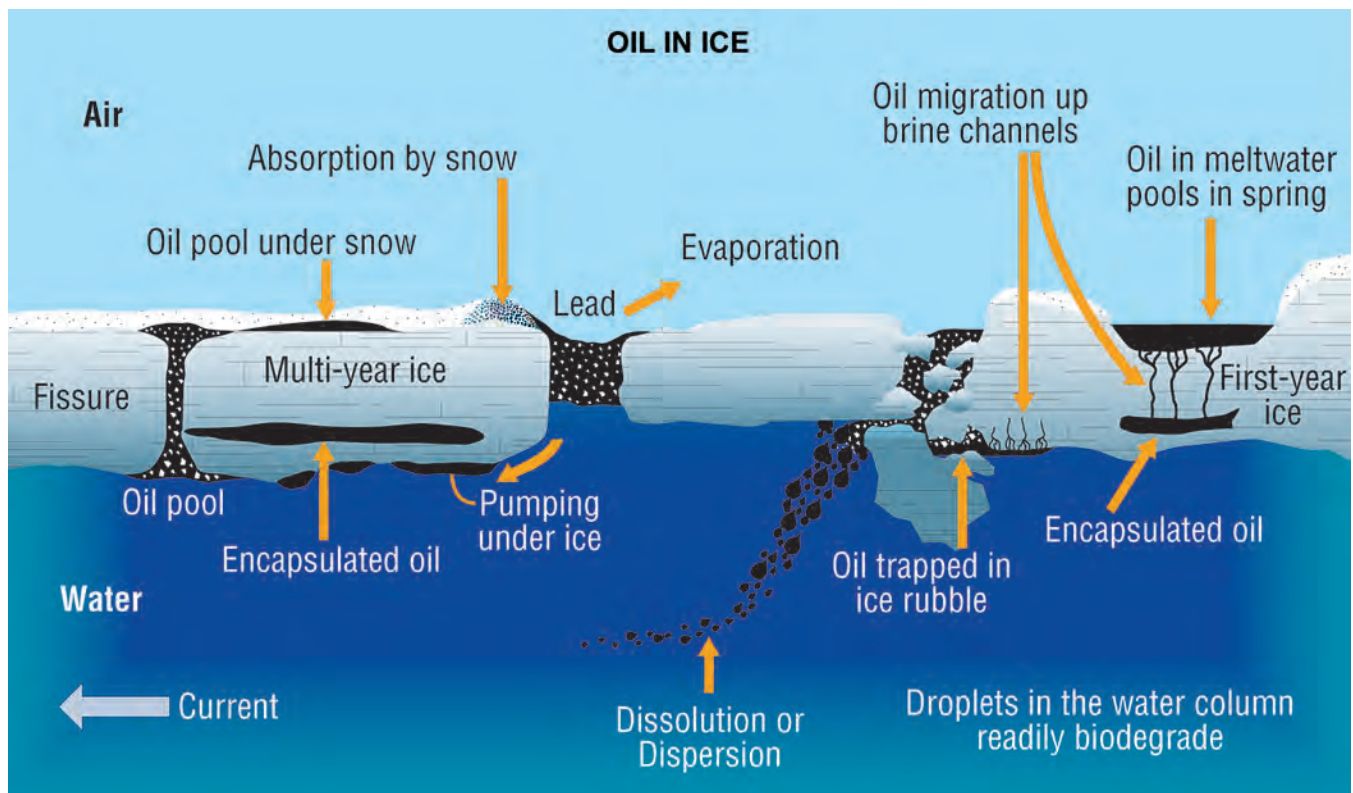

Source: ExxonMobil.

**Figure 8-9.** Depiction of Oil Interacting with Ice

encapsulation keeps the oil from weathering, emulsifying, and dispersing.

Sea ice includes multiple vertical brine channels that form as brine is excluded from ice as it freezes. These channels allow the dense brine to migrate down and release to the water below. When oil interacts with sea ice, it migrates up these natural brine pathways because it is less dense than both the brine and seawater.<sup>129</sup> Vertical migration accelerates in the spring as the ice melts, resulting in the oil pooling on the ice surface in melt pools (Figure 8-10). Oil in these natural melt pools is more readily available to responders prior to ice break-up.

Oil located on top of continuous ice will likely undergo limited spreading due to the roughness of the ice surface and snow. The oil on top of ice will ultimately be much thicker and cover a smaller area than the same oil spilled on open water. The end result is that in many cases ice will allow responders time to mount a response.

Snow can combine with oil on the surface of ice to the point that the resulting mixture can be as much

as 80% snow.<sup>130</sup> Oil-snow mixtures can be handled by shovel, bulldozer, etc. if the ice is stable enough, but it may not be burnable depending on the amount of snow.

Oil trapped in ice leads and fissures is also contained by the ice depending on the amount of ice cover. Two experimental field releases illustrate the restricted spreading caused by ice cover.<sup>131</sup> After 10 hours of spreading the thickest portion of an open water slick covered 100,000 m<sup>2</sup> while a spill in broken ice covered only 100 m<sup>2</sup>.

In general, oil spilled on or under ice or within concentrated ice coverage will move with the ice if it is drifting or remain near the spill location for land-fast ice or ice that isn't drifting. In more open ice conditions, oil and ice can move at different rates and directions.

The above discussion was primarily focused on oil behavior in first-year ice. Oil behavior in multi-year ice may be somewhat different. The under-ice storage capacity of multi-year ice is estimated to be greater than first-year ice. Oil under multi-year ice



Photo: National Oceanic and Atmospheric Administration.

**Figure 8-10.** *Melt Pools (Water Only) Formed on Top of Ice During Spring in the Arctic. Oil Trapped in Ice Will Flow to the Ice Surface and Float in These Melt Pools Prior to Ice Break-Up*

can also encapsulate, and it may persist within the ice for more than 1 year.

A final point on oil behavior in ice is its fate during spring melt. Oil trapped in ice during the winter and not treated will eventually be released during the spring melt. Spring melt requires multiple weeks to occur (Dickins, 2011).<sup>132</sup> The oil will release slowly to reduce loading at any location and this will facilitate natural dispersion and evaporation.

## **DISPERSANT USE IN THE ARCTIC**

### **Introduction**

Mechanical recovery will always be the most widely used oil spill response technique because it returns oil to containment. It can be effective on smaller spills, which are by far the most common. However, for large offshore spills and spills in ice this technique has limitations. Mechanical recovery has only treated a fraction of large, geographically dispersed offshore oil spills in the past. The oil industry has developed non-mechanical response tools, namely dispersants and burning, to more effectively treat large offshore oil spills because of these limitations. The additional complications resulting from spills in ice means it is even more important for all response tools to be given equal consideration during contingency planning and an emergency event.

This section will describe and summarize more than 20 years of research that shows dispersants can work in ice, research on the fate and effects of dispersed oil in the Arctic, and summarize some recent advances made for dispersant use in the Arctic.

### **Dispersants Use in Marine Environments**

Dispersants enhance the natural dispersion of oil into water. The goal of dispersant use is to reduce environmental impacts caused by surface slicks (e.g., impacts to marine mammals, seabirds, marshes, etc.), rapidly reduce oil toxicity through dilution, and ultimately enhance the biodegradation and removal of oil from the environment. Dispersants can be used over a wider range of environmental/meteorological/oceanographic conditions than other response options. They are efficient in high seas and on thin slicks.

Dispersants are the only oil spill response option that has been delivered by aircraft (planes and helicopters, in addition to by vessel and subsurface) although research is currently underway to develop solely airborne methods of applying in-situ burning. Industry is in the process of qualifying a 727 airplane for dispersant delivery. Aircraft allow dispersants to be moved to a spill location at high speed. Further, aircraft can treat large oil slicks much faster than boats. The remoteness of many Arctic locations means rapid transit speeds are even more critical.

Dispersed oil rapidly dilutes to concentrations below acute toxicity thresholds and allows much more rapid biodegradation of the oil by naturally occurring bacteria. This results in the accelerated recovery of the marine environment. The schematic drawing in Figure 8-11 illustrates the steps that occur during the dispersion process.

Dispersants act to reduce oils cohesiveness. Less cohesion allows natural wave energy and currents to break the oil into tiny droplets that dilute into the water column. The significant increase in oil surface area promotes natural bacterial biodegradation.

Dilution of dispersed oil in the water column allows biodegradation without exhausting available oxygen and nutrients.<sup>133</sup> Studies have shown that oil-degrading microbes colonize the droplets within a few days.<sup>134</sup> A recent bench-top biodegradation study that used representatively low concentrations of dispersed oil required only 7 days to lose approximately 50% of the detectable hydrocarbons while surface slicks only lost 14%.<sup>135</sup> Dispersed oil will dilute to concentrations in the parts per million range within a few hours of effective dispersant application and to concentrations in the parts per billion range in one or more days depending upon the currents and wind dynamics.<sup>136</sup>

Cold temperatures do not reduce the dispersibility of many oils or the activity of the dispersant,<sup>137,138,139</sup> and most oils remain dispersible until they are cooled well below their “pour point” (the temperature at which the oil behaves like a semisolid).<sup>140,141,142</sup>

In addition, research has shown that the motion and interaction of broken ice pieces actually enhances the dispersion process by providing surface turbulence that doesn't occur in nonbreaking waves in the absence of ice.<sup>143</sup>

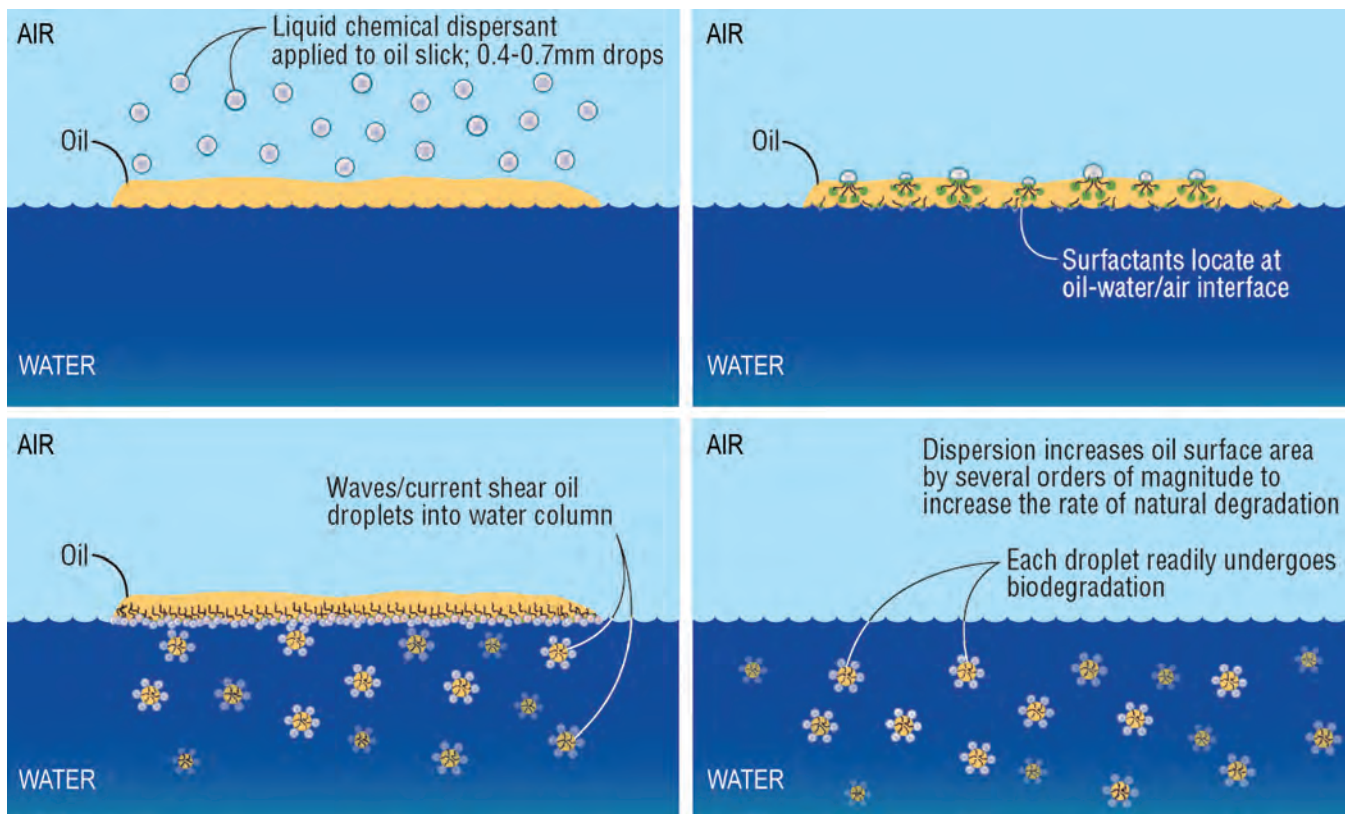

Source: ExxonMobil.

**Figure 8-11.** Schematic Drawing Illustrates the Dispersion Process

Studies have found dispersants are less toxic than both naturally dispersed and dispersant-treated oil.<sup>144</sup> Recent work conducted by the University of Alaska-Fairbanks demonstrated that three Arctic marine species (two fish and a copepod) were no more sensitive to dispersed oil than similar temperate species.<sup>145</sup> The University of Alaska Fairbanks study results dealing with dispersants as reported by the National Oceanic and Atmospheric Administration follow:<sup>146</sup>

- Arctic **marine species show equal or less sensitivity** to petroleum after exposure than temperate (warmer water) species.
- Arctic test organisms **did not show significant signs of toxicity** when exposed to recommended application rates of Corexit 9500 dispersant by itself, which biodegrades on the order of several weeks to a few months.
- **Petroleum does biodegrade** with the help of indigenous microbes in the Arctic's open waters under both summer and winter conditions.
- **Chemical dispersants more fully degraded certain components of oil** than oil that was physically

dispersed (from wind or waves breaking up an oil slick).

- Under various scenarios for large and small oil spills treated with Corexit 9500, the effects on populations of arctic cod, a keystone species in the Arctic, appeared to be **minor to insignificant**.

An important consideration for dispersant use is assessing the benefit of intentionally exposing water-column organisms to dispersed oil versus allowing unrecovered oil to drift at sea and potentially strand onshore. This often provides a net benefit because the short-term, transient exposure of dispersed oil to water-column communities can reduce the ecological effect compared to the prolonged widespread impacts of oil reaching shorelines.<sup>147,148,149</sup> That is, the effective dispersion and biodegradation of oil in the water column results in oil persisting in the environment for periods of days to a few weeks while allowing oil to strand on shorelines results in oil persisting for multiple years. Experts have concluded that oil spills with significant environmental impacts have always been associated with nearshore or intertidal accumulations of oil.<sup>150</sup>

## Subsea Dispersant Injection

Injecting dispersant subsea into a jet of oil resulting from loss of well control is a recent innovation. Subsea dispersant injection was utilized for most of the Macondo incident to keep a significant amount of the oil from reaching the surface. Implementation is relatively straightforward (see Figure 8-12). Equipment needs are a vessel with a supply of dispersants at the surface, a coiled tubing line to transfer dispersant to the subsea well, and a remotely operated vehicle to hold the end of the coiled tubing line into the jet of oil emanating from the release point. For ice conditions, the surface vessel will require some ice management assistance. In addition, workboats may be needed to resupply the dispersants.

Injection of dispersants into a jet of oil subsea provides the same function as surface application of dispersants, i.e., it accelerates the removal of oil from the environment through natural biodegradation. Compared to surface response options, subsea dispersant injection can be much more efficient because it treats the oil at the concentrated source before it has spread at the surface. Subsea dispersants can be applied continuously (24 hours/day), even in low visibility and darkness. Unlike surface response methods, subsea injection is not affected

by storms or ice incursions—assuming appropriate ice management. Subsea dispersant injection is also more efficient because the oil is fresh (and therefore more easily dispersed) and emanating with high turbulence that helps form oil droplets very near the release point. Further, subsea dispersant injection can protect the health and increase the safety of responders. Application of dispersants subsea can protect well control personnel from gas vapors by keeping fresh volatile oil from surfacing near the well site.

## Icebreaker-Enhanced Dispersion

There may be extreme low-energy conditions in ice-covered marine environments. For these situations, or when oil is trapped on or under ice, industry has developed a technique that uses the mixing energy from the propeller wash of icebreakers to disperse dispersant-treated oil.

A study was conducted in an ice basin using a scale-model icebreaker to evaluate the icebreaker-enhanced dispersion concept. Results of these tests indicated that icebreakers can effectively enhance the treatment of oil located in leads between ice floes, on top and beneath solid ice.<sup>151,152</sup> A 2009 field release in the Arctic also used the energy of vessel prop wash to

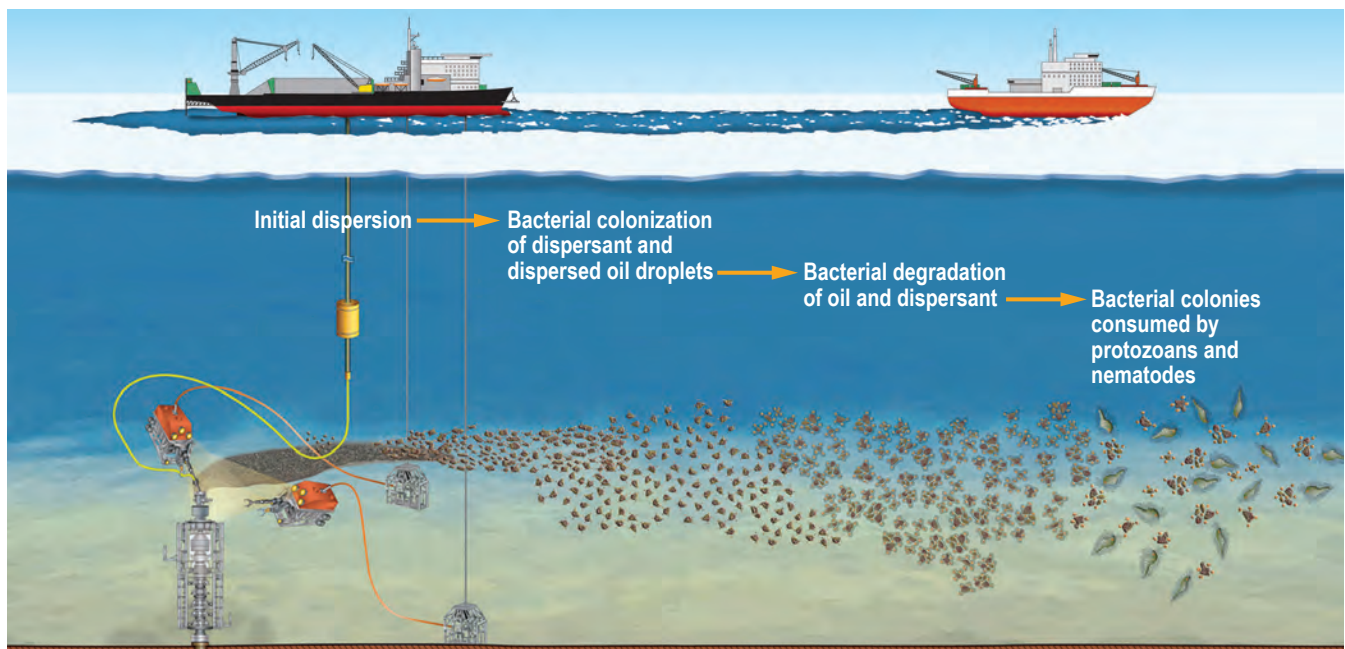

Source: ExxonMobil.

**Figure 8-12.** Subsea Dispersant Injection as It Might Be Applied in Ice

disperse oil slicks in ice.<sup>153</sup> Prior to treatment, the oil had undergone 6 days of weathering in ice.

Although icebreaker enhanced dispersion could be important for Arctic oil spill contingency plans, it will have the same darkness limitation that other response options will have.

## IN-SITU BURNING

### Introduction

Offshore ISB of oil slicks is the process of burning the oil “in place” on the sea surface. The basic requirements for ISB are a method of containing the oil—to keep it from spreading too thin or to thicken the oil if it has already spread—and a method of igniting the thick oil. Most oils slicks won’t burn without some form of containment because they will spread and become too thin to support combustion in an open water marine environment. This is because the oil loses too much heat to the water column and will naturally extinguish. A slick thickness greater than 1 mm is usually needed to insulate the burn from heat loss to the water and allow sustained combustion.

ISB is especially suited for use in the Arctic, where ice can often provide a natural barrier to maintain the necessary oil thickness for ignition without the need for containment booms, and oil remains fresh and unemulsified for a longer period of time. There are decades of experience using controlled ISB as an oil spill response technology in cold water and the Arctic. The first recorded use of ISB was a 1958 pipeline spill in the Mackenzie River, Northwest Territories. Buist et al. provides comprehensive summaries of the history of burning oil in ice-covered environments and under Arctic conditions.<sup>154</sup> Most recently, the massive ISB operation in response to the Macondo blowout provided a unique set of full-scale operational data applicable to response planning for Arctic offshore areas in the summer. This was the first large-scale application of burning in an operational setting.<sup>155</sup>

### Fire-Resistant Booms

Fire-resistant booms pulled by vessels are required for ISB in open water to thicken the oil (in some cases during Macondo when thick oil was encountered in open water it was burned without booms). The first successful use of ISB with fire-resistant booms was a trial conducted during the *Exxon Valdez* response.<sup>156</sup>

Several different types of fire booms were tested during the Macondo oil spill, with some notable differences in their effectiveness for oil retention and durability in the face of fire intensity and sea state.<sup>157</sup> A number of these boom designs were successfully deployed in ice in 2008 and 2009 during the SINTEF Oil in Ice project.<sup>158</sup>

### Ignition Systems

A range of surface hand-held, boat launched, and aerially deployed igniters are described in Buist et al.<sup>159</sup> One of the best known devices is the Helitorch™. A Helitorch™ (shown slung from the helicopter in Figure 8-13) can be found in the inventories of a number of oil spill response organizations charged with responding to spills in ice.

Ignition delivery systems with the potential to operate at much higher speeds from a fixed-wing aircraft were recently tested in ground trials.<sup>160</sup> These systems would be ideal for Arctic applications where multiple oil slicks are trapped in separate leads between ice floes or where oil has risen to the ice surface in multiple melt pools. In addition, the Arctic Response Technology JIP is studying the development of effective, safe, alternative aerial ignition systems for Arctic use.<sup>161</sup>

### Operating Parameters and Limitations

Experience with burning fresh, weathered, and emulsified oils and petroleum products in a range of ice and wind conditions has led to some basic rules of thumb.<sup>162</sup> Wind speeds should not exceed 10 m/s (20 kt). In actual Arctic field tests, burn removal efficiencies of individual slicks have ranged from 65 to over 90%. In an experimental spill under solid ice in Norway, 3,400 liters of crude oil were allowed to surface naturally through the ice and then burned with an overall removal efficiency of 96%. A portion of this oil was allowed to weather on the ice surface for over 1 month before being successfully ignited.<sup>163</sup>

High concentrations of pack ice in combination with slush and brash ice between the floes can greatly enhance ISB by maintaining the original as-spilled thickness, and preventing subsequent thinning through spreading<sup>164</sup>—see Figure 8-14.

In very open drift ice conditions, oil spills can rapidly spread and become too thin to ignite. However,



Photo: Environment Canada.

**Figure 8-13.** *Open Water Burning of Crude Oil in a Fireproof Boom after Ignition with a Helitorch™ During the Newfoundland Offshore Burn Experiment in 1993*

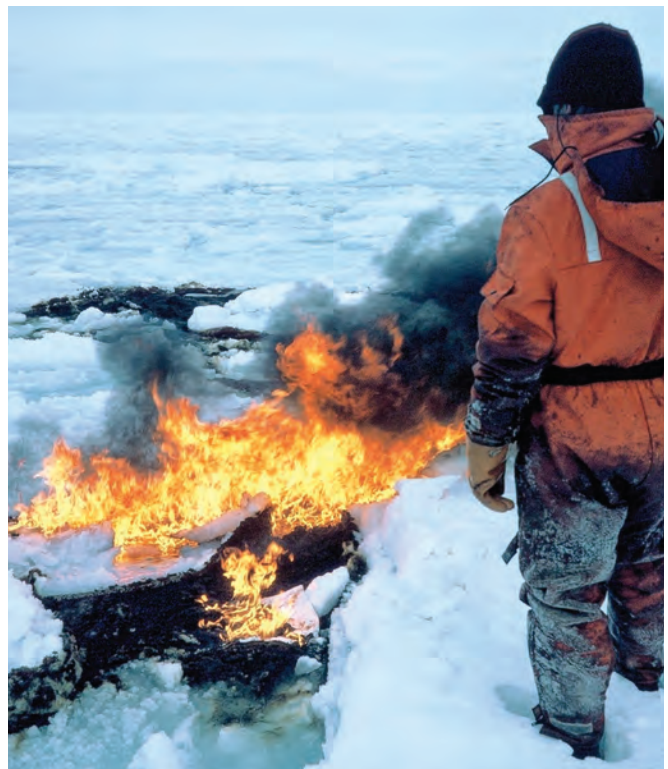
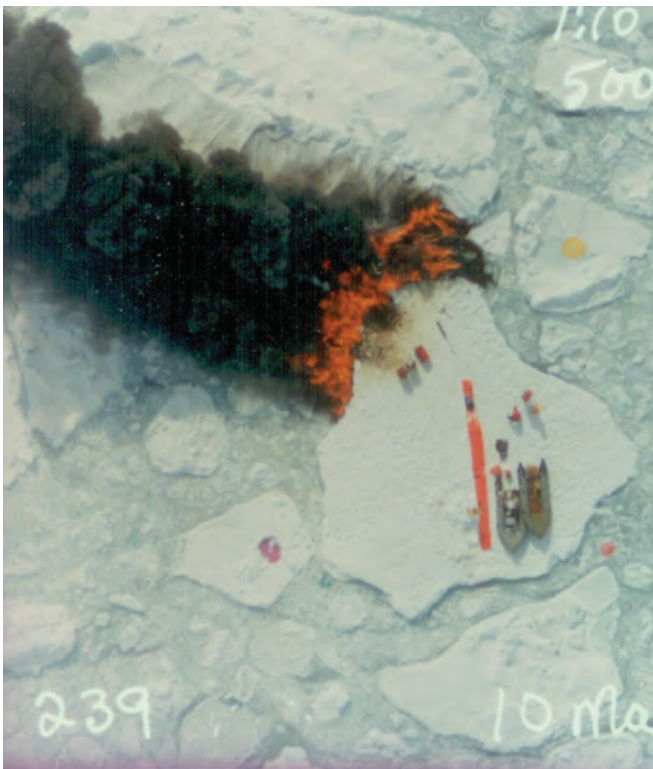

Photos: DF Dickins Associates, LLC.

**Figure 8-14.** *Aerial and Surface Views of Burning Crude Oil Spilled in Slush Between Floes During the 1986 Canadian East Coast “Oil in Pack Ice” Experiment*

fire resistant booms can still operate in these conditions. Potter and Buist<sup>165</sup> reported highly effective (~90%) burning of oil within small ice pieces and brash collected within a fire-resistant boom during 2009 field experiments in the Norwegian Barents Sea—see Figure 8-15.

In the same project, oil that was allowed to drift and weather in very close pack ice for over a week without any booming was also successfully ignited and burned with high efficiencies.<sup>166</sup>

In the case of spills in solid ice nearshore, the choice of whether to burn on site or remove the oil to shore will depend on the time of year, ice conditions and water depth. On-site burning might become the preferred option late in winter when there would be insufficient time to transport the recovered oil to shore prior to break-up.

Despite highly successful test results over four decades, there is continued concern that actual spill conditions could reduce the effectiveness of ISB to far below results seen in controlled field trials.<sup>167,168</sup> In

practice, burn efficiencies greatly increase with the scale of the burn as the strong radial influx of air feeding the burn acts to continually thicken the remaining slick. This effect was readily apparent in the massive ISB operation during the Macondo response and has been observed in a number of large-scale experiments with burning oil on ice and at sea.<sup>169,170</sup> Further, the natural containment provided by ice and the reduced weathering of thick, cold oil could significantly increase the time available for implementing ISB in Arctic conditions compared to a similar scale oil spill in open water.

## Safety and Environment

Well control blowouts involve a mixture of oil and gas (mostly methane). The volatile gases resulting from a subsea blowout can produce an explosive atmosphere in the immediate vicinity of the surfacing oil. ISB, however, will always be conducted at a safe distance from the discharge point to avoid accidental ignition. Most of the oil in an in-situ burn is converted to carbon dioxide and water with some particulate matter and floating residue.



Photo: SINTEF.

**Figure 8-15.** *Burning Crude Oil Spilled into a Field of Small Ice Cakes Collected in a Fire-Resistant Boom – Norwegian Barents Sea*

Research completed in the 1990s assessed the potential environmental impacts of ISB, primarily from smoke plume and burn residues.<sup>171</sup> The smoke plume emitted by burning an oil slick on water is often the primary ISB concern to the public and regulators. In practice, smoke particulates and gases are quickly diluted to concentrations below levels of concern. Work by Canadian and U.S. teams advanced the understanding of smoke constituents and how to predict downwind environmental impacts and to gather data for verification of existing plume models.<sup>172</sup> Research conducted at several scales including a full scale test offshore Newfoundland<sup>173</sup> demonstrated that when conducted in accord with established guidelines, ISB is safe and poses no risk to human populations or responders and no unacceptable risk to wildlife.

Burn residue—the unburned oil that remains on the surface of the water after a fire extinguishes—was also studied in the 1990s. Daykin et al.<sup>174</sup> and Blenkinsopp et al.<sup>175</sup> studied burn residue’s potential for aquatic toxicity, while an industry-funded research program examined the likelihood of burn residue sinking as it cooled. The toxic components of oil are mostly the volatile components. The intensity of the burn tends to destroy these volatiles. Bioassays of burn residue showed very little or no acute toxicity to oceanic organisms for either weathered oil or burn residue. These findings of little or no impact were validated with further studies by Gulec and Holdway<sup>176</sup> and Gagnon and Holdway.<sup>177</sup> Roughly 50% of cooled burn residues were found to float in the industry-funded study.

Numerous agencies, primarily in the United States, have established guidelines for the safe implementation of ISB as a countermeasure.<sup>178,179,180,181,182</sup>

## Recent and Ongoing Research

In 2004, a multi-year joint industry and government project began to study oil-herding surfactants to thicken slicks for ISB as an alternative to booms in open water and light ice conditions. The herders proved effective in significantly contracting and thickening oil slicks in brash ice. Burn efficiencies measured for the herded slicks were only slightly less than the theoretical maximums achievable for equivalent-sized, physically contained slicks on open water.<sup>183</sup>

The concept of using herding agents to burn free-drifting oil slicks in pack ice was successfully field tested for the first time in the Norwegian Barents Sea in 2008 as part of the SINTEF Oil in Ice JIP.<sup>184</sup> Figure 8-16 shows images of the field test. Buist et al.<sup>185</sup> summarizes past research into herders and concludes that oil spill responders should consider utilizing them to enhance ISB in light to medium ice concentrations.

Of equal priority to improving the technology behind executing an offshore burn (see Recommendations) is the need to effectively communicate the broad body of scientific evidence that proves the safety and environmental acceptability of burning.



Photos: DF Dickins Associates, LLC.

**Figure 8-16.** Photo Sequence Showing Before and After Shots During the First Field Test of Herders under Arctic Conditions in Norway, 2008

## OFFSHORE MECHANICAL RECOVERY

Mechanical recovery of oil spills on land and on/under landfast ice has been practiced for decades and is summarized in many publications and manuals. When it is safe to do so, mechanical recovery will always be considered and used if it can be efficiently applied and is supported from the Net Environmental Benefit Analysis (NEBA) perspective. In fact, for small operational spills near sufficient stockpiles of equipment, mechanical recovery may be the only response option required. Given that the vast majority of spills are small, mechanical recovery will often be the primary response option, even in the Arctic. This section describes capabilities and limitations of mechanical oil spill recovery in offshore Arctic regions.

The goal of offshore mechanical recovery is to collect and remove oil from the surface of water using collection booms and specially designed skimming devices or sorbent materials. This technique is often favored because when mechanical recovery is successful, oil is “removed” from the marine environment. This consideration, however, does not account for the fact that mechanical recovery may be insufficient in recovering large volumes of oil or ineffective due to wind and sea conditions.

A NEBA for the use of mechanical recovery in Arctic waters needs to adopt a full life cycle approach and consider environmental impacts associated with all phases of the response operations. Benefits and trade-offs of using mechanical recovery will then need to be compared to the use of other response options to ensure that the selected response technique or a combination of response techniques maximizes environmental protection.

The containment and recovery of oil can be effective when responding to small operational spills and spills in relatively calm waters without heavy concentrations of ice or debris. The dynamic nature of large spills (i.e., the rapid spreading, movement, break-up into patches) challenges mechanical recovery even in locations with large equipment stockpiles and good weather conditions.

Reliance upon mechanical recovery alone for cleaning up large widespread slicks in remote offshore regions may diminish protection of the Arctic

environment and communities depending on these resources. In such cases the entire “response toolbox” should be available to responders. This is especially true for the offshore Arctic environment.

Decades of experience with mechanical recovery under cold-climate conditions around the world have advanced the understanding of the process. Ice-strengthened vessels are necessary in Arctic waters where ice may be present. Several configurations of Arctic-capable response vessels, both with built-in and over-the-side recovery equipment, have been designed and are currently in operation.<sup>186</sup> There have been important advances in the design of Arctic skimming systems.<sup>187,188,189,190</sup>

Advances with Arctic skimmers include improved oil and ice processing, the ability to handle larger volumes of cold viscous oils and oil/ice mixtures with low water uptake, and the heating of critical components to prevent freezing. Various viscous oil pumping systems and techniques have also been developed to facilitate efficient transfer of cold and viscous mixtures of oil water and small ice pieces.<sup>191,192,193</sup>

Since an uncontained oil slick can spread on open water to very thin layers (thinner than a piece of paper), containment is almost always required to concentrate oil into a thicker layer thereby increasing the efficiency of skimming systems. At 0 to 10% drift ice coverage conventional open water containment and recovery techniques can be used. At 10 to 70% drift ice coverage, vessel-towed booms can be replaced with short sections of a boom connected to an ice-strengthened skimming vessel with “outrigger arms.” At drift ice coverage greater than 70%, specialized skimmers are operated by ice-strengthened response vessels. At high ice concentrations, booms cannot be used; however, the ice itself often provides containment. In this case oil may be recovered from concentrated “pockets” between ice pieces using ice-strengthened vessels that can place skimmers directly into these pools of oil.

Oil encounter rate (the amount of oil accessed by a skimming system per unit of time) often determines the feasibility and effectiveness for mechanical recovery. Conventional containment booms cannot be towed at speeds greater than about 1 knot. In recent years there have been a number of innovative designs capable of containing oil at greater speeds.<sup>194,195</sup> These systems allow collection of oil at

speeds around 3 knots in calm water and 2 knots with light to moderate waves. Such systems can significantly improve encounter and recovery rates.<sup>196</sup> The recent Wendy Schmidt Oil Cleanup X CHALLENGE resulted in development of several novel skimming approaches.<sup>197</sup> The Boom Vane™ is another innovative technique, which allows the positioning of containment booms while using fewer boats.<sup>198</sup>

Sea state is another important consideration for mechanical recovery as oil is challenging to contain in waves exceeding 3 to 4 feet. Mechanical recovery equipment can operate in more developed “swell” waves not exceeding 5 to 6 ft. Increasing wave heights make equipment deployment/retrieval difficult, reduces the effectiveness of skimmers, reduces the ability of the boom to contain the oil, and may result in unsafe working conditions.

Critical factors for an effective containment and recovery operation in a remote Arctic location include the availability of resources to store recovered oil/water/ice mixtures on skimming or specialized vessels; the ability to transfer recovered fluids to intermediate storage; and the availability of suitable facilities for oil disposal. For a large spill these activities can be logistically challenging.

Just as with oil spill response in open water, effective oil slick identification and location, spotting for vessels, and the monitoring of response performance is critical to the success of the overall response operation. During much of the open water period in the Arctic when containment and recovery methods are most feasible, extended daylight facilitates these activities and allows the use of conventional remote sensing and observation techniques. During periods of darkness and for detection of oil under ice, specialized techniques must be used as discussed in Chapter 5, Characterization and Measurement of the Ice Environment.

## **REMOTE SENSING FOR THE DETECTION AND MAPPING OF OIL IN ICE**

### **Introduction**

Successful oil spill response in any environment requires locating, mapping and tracking oil as it moves away from the source of the spill. This

is equally important in the Arctic due to potentially limited response assets and logistical challenges. The purpose of this section is to summarize the current techniques and capabilities for detecting oil on, among and in/under ice, mapping the extent of the oil, and monitoring the oiled ice movements.

Some of the remote sensing (RS) and survey challenges that must be overcome for winter Arctic conditions are visibility (blowing snow, low cloud, fog and darkness), weather (low temperature and wind), ice/snow cover, and remoteness.

These challenges of Arctic offshore and ice conditions will likely require a mix of remote sensors operating in different parts of the electromagnetic spectrum. Detailed assessments of remote sensing systems for oil spills in ice have been summarized by others.<sup>199,200</sup>

A wide range of sensor types have been tested through analytical, bench and basin tests and field trials for use in spill detection in ice. Beginning in 2004, projects sponsored by the Minerals Management Service (now the BSEE) and industry studied a variety of open water sensors to evaluate their potential for detecting oil in ice. This project studied old and new technologies including side-looking airborne radar, synthetic aperture radar (SAR) satellites, forward-looking infrared (FLIR), trained dogs, and sonar.<sup>201,202</sup> Table 8-1 compares the capabilities of different sensors for spills in ice over a range of ice environments.<sup>203</sup> Expected capabilities of different systems are based on conclusions from the SINTEF JIP and other experiments and from results of previous trials, not necessarily in the Arctic.

Dickins and Andersen<sup>204</sup> concluded that current airborne systems are useful for detecting and mapping large spills in open ice but have less potential as the ice concentration increases. Many of the non-radar sensors on airborne systems do not work well under Arctic conditions of darkness, cloudiness, fogginess, and rain for much of the year. A large advance in all-weather capability was realized in the late 1990s with the advent of commercially available, high-resolution SAR satellite systems that can now resolve targets of a few meters and are unaffected by darkness or cloud cover (e.g., Radarsat, ERS-1, TerraSAR-X, COSMO-SkyMed) and were effective in mapping several large marine spills.<sup>205,206</sup> The ability of SAR satellites to detect and map oil slicks in the ocean with

Platform	Ice Surface		AUV		Shipborne			Airborne			Satellite	
	Dogs	GPR	Sonar	Marine Radar	FLIR	GPR	Visible	UV	FLIR	SLAR	SAR	
<b>OIL ON ICE</b>												
Exposed on cold ice surface	Likely	Not applicable	Not applicable	Not likely	Likely*	Likely	Likely*	Not likely*	Likely*	Not likely	Not likely	
Exposed on spring melt pools	Likely	Not applicable	Not applicable	Possible	Likely*	Not likely	Likely*	Possible*	Likely*	Possible	Not likely	
Buried under snow	Likely	Likely	Not applicable	Not applicable	Not likely*	Likely	Not likely*	Not likely*	Not likely*	Not likely	Not likely	
<b>OIL UNDER ICE</b>												
Smooth fast ice	Possible	Likely	Likely	Not applicable	Not applicable	Likely	Not applicable	Not applicable	Not applicable	Not likely	Not likely	
Deformed pack ice	Possible	Possible	Likely	Not applicable	Not applicable	Possible	Not applicable	Not applicable	Not applicable	Not likely	Not likely	
<b>OIL IN ICE</b>												
Discrete encapsulated layer	Possible	Likely	Possible	Not applicable	Not applicable	Likely	Not applicable	Not applicable	Not applicable	Not likely	Not likely	
Diffuse vertical saturation	Possible	Possible	Not likely	Not applicable	Not applicable	Possible	Not applicable	Not applicable	Not applicable	Not likely	Not likely	
<b>OIL BETWEEN ICE FLOES</b>												
1 to 3/10 concentration	Not applicable	Not applicable	Not likely	Likely	Likely*	Not likely	Likely*	Likely*	Likely*	Likely	Likely	
4 to 6/10 concentration	Not likely	Not applicable	Not likely	Possible	Likely*	Not likely	Likely*	Possible*	Likely*	Possible	Possible	
7 to 9/10 concentration	Possible	Not applicable	Not likely	Not likely	Likely*	Not likely	Likely*	Not likely	Likely*	Not likely	Not likely	

Notes: AUV – autonomous underwater vehicle; GPR – ground penetrating radar; FLIR – forward-looking infrared; SLAR – side-looking airborne radar; SAR – synthetic aperture radar. An asterisk (\*) denotes sensors blocked by dark/cloud/fog/precipitation.

Source: D. F. Dickens and J. H. S. Andersen, "Remote Sensing Technology Review and Screening," SINTEF Oil in Ice JIP, Report 22, 2009.

**Table 8-1. Overview of Remote Sensing Systems for Oil in Ice Detection**

moderate wind conditions is likely to be practical for well-defined oil spills that spread in open to very open pack ice.<sup>207</sup> Satellites are expected to have less utility for detecting oil in concentrated ice and oil trapped under ice and snow.

Leifer et al. summarized how passive and active satellite and airborne marine remote sensing were applied to a recent spill.<sup>208</sup> The Moderate Resolution Imaging Spectroradiometer (MODIS) satellite data allowed for detection of the total slick and was used to produce maps of estimated oil thickness. SAR provided synoptic data under all-sky conditions. SAR is not able to discriminate between thick oil slicks and thin sheens (0.1 mm or less); however, it can be used as a strategic response planning tool rather than a real-time tactical tool.

### Sensors and Platforms— Current Capabilities

Detection and mapping of oil in ice will likely require a mix of sensors operating in different spec-

tral bands, both passive and active, ranging from AUV sonar to synthetic aperture radar satellites. Included in the mix is the human observer, perhaps still the most reliable “sensor,” in spite of the limitations of darkness and adverse weather. Figure 8-17 shows a Coast Guard overflight of skimming operations.

Much of the early research on spill detection in ice took place over a 10-year period beginning in the late 1970s. Since that time researchers carried out analytical, bench, and basin tests and field trials using a wide range of sensor types.<sup>209,210</sup>

At present, knowledge of which sensors are most likely to succeed in different oil in ice scenarios is based largely on experiences in temperate spills supported by a small number of field tests and tank/basin experiments. A number of researchers have summarized the present state of knowledge.<sup>211,212</sup>

Overall conclusions from this work were that the current generation of airborne systems have



Photo: United States Coast Guard.

**Figure 8-17.** Coast Guard Overflight of Skimming Operations June 12, 2010. Coast Guard Air Crews Regularly Conducted Aerial Surveillance in Support of the Deepwater Horizon Oil Spill Response.

a high potential for detecting and mapping large spills in very open ice, but less potential as the ice concentration increases. Many non-radar sensors are blocked by darkness, cloud, fog, and precipitation, all of which are common over Arctic waters for much of the year.

There is a lack of hard data to confirm theoretical assumptions about the performance of most RS systems in a particular oil in ice scenario (ground penetrating radar, discussed below, is one exception). SAR satellite imagery may be of use for detecting oil slicks in ice but will be dependent on factors such as the size of the spill, ice floe size and concentration, and wind speed. Radar imagery can also document changing ice conditions near a spill, which provides a valuable tactical tool for response.<sup>213</sup> False positives and negatives are also a concern with SAR imagery.

An important national issue is that the United States does not presently have its own commercial SAR satellite mission, so international partnerships as well as government/industry collaboration are necessary. Classified SAR satellites from the National Geospatial-Intelligence Agency can be used for monitoring natural disasters and oil spills, but the information is only available to those people with appropriate clearances. However, derivative maps can be made using the data.

In addition to rapidly developing RS technologies, there will always be a need for well-trained observers flying in helicopters and fixed-wing aircraft to map oiled areas and to transmit critical information to response crews. This was evident during a recent large Gulf of Mexico offshore oil spill.<sup>214</sup>

Commercially available ice-strengthened global positioning system (GPS) beacons and buoys have, for many years, been tracking ice movements during an entire winter season throughout the polar basin.<sup>215</sup> Oil containment and entrapment that may occur in ice means that beacons placed on top of the ice cover where oil is known to be will effectively track the oiled ice until oil is released by a response action (i.e., icebreaker intervention) or spring melt. There are also subsurface Lagrangian floats that can operate in ice-covered waters and be acoustically tracked while under sea ice.

## **New Concepts and Ongoing Developments in Detection and Monitoring**

Basin and field experiments showed that surface-based, commercially available ground penetrating radar can detect and map oil 1 to 3 cm thick underneath 1 m or more of solid ice or trapped as layers within ice.<sup>216</sup> The same radar suspended beneath a helicopter traveling at speeds up to 20 knots and altitude up to 20 m successfully detected a thin layer of crude oil buried under hard-packed snow.<sup>217</sup> A frequency-modulated continuous-wave radar designed to detect oil trapped under solid ice from a low-flying helicopter is under development (ART JIP, in progress).

Nuclear magnetic resonance is being studied as a potential means to detect oil trapped under or in ice.<sup>218</sup> A full-scale prototype system is currently under evaluation.

Infrared (IR) systems (alone or in conjunction with other sensors) can also be used from the surface, low-flying aircraft or surface vessels. A low-cost hand-held IR sensor was able to discriminate between oil, open water, snow, and oil-free ice during daytime.<sup>219,220</sup> IR systems have also detected oil under snow. Ocean Imaging Inc. successfully used multi-spectral and thermal IR cameras to detect, map and estimate thickness of slicks during a recent offshore spill. A key issue is how thermal IR will work in the Arctic winter.

As part of the SINTEF JIP, trained dogs on the ice tracked and located small oil spills buried under snow from a distance of 5 km and also mapped dimensions of a larger oil spill.<sup>221</sup>

X-band marine radar has been used to detect slicks during sea trials and may be able to detect oil slicks in open ice.<sup>222</sup> Commercial systems are available and in place on marine spill response vessels today in the United States and Norway. Integrated systems that combine high-resolution FLIR and low-light cameras are now routinely deployed on response vessels in Norway.

UAVs and AUVs have the capability of carrying useful sensor packages over long distances (albeit at slow speed under water) for Arctic oil spill surveillance.<sup>223</sup> Both single- and multi-beam sonar sensors successfully detected and mapped oiled boundaries

and thicknesses under ice in a recent basin test.<sup>224</sup> An exercise aboard the USCG Healey evaluated UAVs and AUVs. Further industry-sponsored testing of different UAV sensors for oil spilled in ice is planned for 2014.

BSEE recently partnered with the Army Research Development and Engineering Command to develop new sensing capabilities that could have applications during low-light periods. Industry continues to follow sensors and platforms developed by the Department of Defense as they become available.

Some Arctic nations operate dedicated pollution surveillance aircraft. Canada dedicates one of its aircraft to Arctic missions. The USCG operates a fleet of jets for maritime surveillance. The search radars in USCG fixed-wing aircraft have a SAR setting that can be used for oil spill detection. These fixed-wing aircraft and some helicopters also have an electro-optical/IR system that may be useful in some Arctic conditions.<sup>225</sup>

A key aspect of the future effectiveness of remote sensing systems is the ability to integrate different datasets into a useful real-time or near-real-time product. There has been considerable progress on developing real-time/near real-time multispectral data, and progress needs to continue to fully develop this capability for the Arctic.

## Summary

It is clear that no single RS technology or sensor package is capable of detecting oil in the Arctic environment under all conditions. Certain methodologies described above can detect oil under certain conditions but all systems have their limitations either due to low visibility including darkness or sea state limitations that generate waves. Logistical constraints can limit sensor capabilities either due to remoteness or lack of deployment platforms. Many sensor technologies show promise but more research needs to be conducted.

There is an extensive ongoing research effort through the International Association of Oil & Gas Producers Arctic Oil Spill Response Technology JIP to evaluate the capabilities of a range of surface and subsea sensors to detect oil trapped in ice. These tests will hopefully lead to integrated sensor packages that

can better detect spilled oil in the Arctic under a variety of adverse conditions.

## ENVIRONMENTAL IMPACTS OF OIL AND RESPONSE OPTIONS IN ARCTIC WATERS

### Introduction

The choice of response technique for a specific spill has to consider possible impacts of untreated oil on one or more components of the ecosystem and compare the option of no action to possible impacts of oil treated with one or more response techniques. Industry recommends basing trade-off decisions on a structured Net Environmental Benefit Analysis (NEBA) approach.<sup>226</sup> This approach is designed to develop a response strategy that minimizes the environmental impact from the spill and facilitates the fastest recovery.

As data continue to accumulate on the environmental effects of oil spills in the Arctic, response decisions can still be made using a combination of Arctic-specific data and relevant data from studies done in temperate regions. More than 40 Arctic species have undergone toxicity testing with either crude oil or crude oil components and the results compared to temperate counterparts.<sup>227,228,229</sup> The conclusion is that the 40+ Arctic species tested are no more sensitive to crude oil and crude oil components than temperate species. This indicates that the larger database of temperate-region studies is relevant to comparable Arctic species. In addition, this same study found that oil biodegrades under Arctic conditions using Arctic microbes at rates approximately half the expected rate in warmer regions and not an order-of-magnitude slower.<sup>230</sup>

This section reviews the NEBA process, the differences in environmental impacts resulting from the various response strategies, and the toxicity and biodegradation of treated and untreated oil.

### Net Environmental Benefit Analysis

Efroymson et al.<sup>231</sup> describes NEBA as a methodology for comparing and ranking the net environmental benefit associated with multiple response alternatives. At its core, NEBA is an assessment of the advantages and disadvantages of implementing

differing response options judged against a natural attenuation strategy. NEBA is not a new invention.<sup>232</sup> Systems for making environmental protection trade-offs regarding oil spill countermeasures were originally developed in North America in the 1970s and 1980s.<sup>233</sup> A system was developed in the United Kingdom and the term Net Environmental Benefit Analysis was applied in the late 1980s.<sup>234</sup> As new spill response technologies have been developed over the years (e.g., in-situ burning in the 1990s) they were added to the NEBA process.<sup>235</sup> NEBA is often conducted pre-spill to facilitate contingency planning and establishment of preapproval areas for certain response techniques. NEBA principles can also be implemented during the spill to ensure that spill-specific circumstances are taken into consideration and that tailoring response techniques to changing spill conditions maximizes the environmental benefit.

Scientific research, scientific data, and lessons learned from historical spills, expert knowledge, local knowledge, and numerical models are all available to support NEBA and the subsequent selection of the most environmentally responsible response techniques for different Arctic environments. In this analysis, environmental impact severity, its duration, and recovery rates of populations, communities, and ecosystems should all be considered. Several studies have addressed population-level impacts in the Arctic.<sup>236,237,238</sup> Our understanding of potential environmental impacts can be further advanced by additional studies of the population-level dynamics as well as by evaluating how resilient Arctic biological communities are and how they recover after initial impact. Studies also should consider multi-stressor models, where an oil spill would be an additional stressor to biological communities that are already being impacted by other stressors.

The National Research Council study *Responding to Oil Spills in the U.S. Arctic Marine Environment* made a recommendation supporting the use of NEBA as the decision process to select the response options that offer the greatest overall reduction of adverse environmental impacts.<sup>239</sup>

## Exposure of Marine Organisms to Dispersed Oil

Justification for the use of dispersants over mechanical recovery requires a NEBA-based process.

This is because of the perception issues with regard to adding soap-like treating agents to the environment and the fact that the oil isn't directly removed from the water. The basis for analyzing the value of using dispersants for oil spill response is understanding the effects that dispersed oil has on marine organisms.

The key determinants of effects on organisms exposed to dispersed oil are the sensitivity of the species and the level and duration of the exposure. Numerous studies have contributed to our understanding of the fate and behavior of physically and chemically dispersed oil and this information can be used to assess exposure to water column organisms during a spill event.<sup>240,241,242,243,244,245,246,247,248</sup>

These studies have shown that under open water conditions, both physically and chemically dispersed oils dilute rapidly as a result of wave and current action and water mixing. This results in oil concentrations quickly reducing over time. Available data suggest that, following initial dispersion, maximum dispersed oil concentrations are less than 50 milligrams/liter (mg/L) and that dispersed oil concentrations reduce to 1 to 2 mg/L in less than 2 hours.<sup>249,250,251,252,253,254</sup> Trudel et al. showed that, even in closed wave tanks, concentrations of dispersed oil are rarely higher than 100 mg/L.<sup>255</sup> With time, dispersed oil plumes continue to dilute and offshore concentrations of dispersed oil are estimated to fall below a threshold for acute impacts in much less than a day.<sup>256,257,258,259,260</sup> As a result, exposure of water column organisms to offshore dispersed oil (chemically or physically) is short and limited to the top few meters of the water column during application of dispersants at the water surface (vessel/aerial).<sup>261</sup>

Small-scale field tests have indicated that dispersants also rapidly dilute even in the absence of dispersed oil. Concentrations of dispersant in water have been shown to reduce to less than 1 mg/L within hours, which are generally below estimated toxicity levels derived from experiments with constant exposure.<sup>262</sup>

## Dispersed Oil Toxicity

Many years of laboratory testing and field research have generated a large amount of acute toxicity data that can be used for assessing environmental impacts. Several field and mesocosm studies have not only characterized the environmental fate of the oil, but

also the impacts on organisms.<sup>263,264,265,266,267,268,269</sup> Not all of these studies provide sufficiently detailed exposure-response data. Most of the currently available toxicity data on chemically dispersed oils were generated under controlled laboratory test conditions. The challenge with much of the available data is that they were obtained in the laboratory using exposure concentrations significantly exceeding those that would be experienced under field conditions with more realistic dilution rates.<sup>270,271,272,273</sup> Bejarano et al. discussed the large variety in exposure methods, oil type and treatments, and the complications when interpreting and applying these data for impact assessments.<sup>274</sup> Several efforts have been made to review the available laboratory toxicity data and facilitate the development of useful benchmarks that help inform decision-makers.<sup>275,276,277,278,279,280,281,282,283</sup>

Results from laboratory exposure tests indicate that for most standard invertebrate toxicity testing species, acute toxicity levels (48 to 96 hours) for dispersed oil are in the 1 to 10 mg/L range. Water-column concentrations exceeding these levels in an actual spill situation may only occur in the top few meters over an area roughly equivalent to the surface slick treated by dispersant, and these concentrations are limited in time because of rapid dilution. While some sublethal impacts could take place even at low hydrocarbon concentrations, significant adult mortality effects on adult fish populations from dispersant use in the past 40 years have not been observed.

### **Comparative Sensitivity of Arctic vs. Non-Arctic Species**

There has been a considerable effort in the past 5 to 10 years to better understand the sensitivity of Arctic species to dispersed oil. The majority of studies exposed copepods and fish larvae to crude oil or individual polycyclic aromatic compounds.<sup>284,285,286,287,288,289,290,291,292</sup> Several studies addressed the toxicity of chemically and physically dispersed oil.<sup>293,294,295</sup> These studies found that chemically dispersed oil had approximately the same toxicity as physically dispersed oil when comparisons were based on the measured concentration of oil in the water column. Further, the concentrations causing acute toxicity in these studies would only be expected in the first few hours after a real spill and only in a limited area in the vicinity of the treated slick because of the rapid dispersed oil dilution.

The amount of data on the toxicity of dispersed oil to Arctic species is less than the data available on sub-Arctic, temperate, and tropical species—although a significant amount of Arctic data exists.<sup>296,297,298</sup> As this data gap closes, the available data on Arctic species combined with the non-Arctic data can be used to assess environmental impacts of dispersants. To support this, a number of studies have been completed to assess the potential relevance of non-Arctic acute toxicity data for assessing Arctic species' sensitivity.

De Hoop et al. conducted a literature search and found toxicity data on crude oil or single components of crude oil for 41 Arctic species with comparative data for 49 temperate species.<sup>299</sup> This literature assessment concluded that Arctic species were no more sensitive to crude oil or the crude oil components tested than temperate species. Olsen et al.<sup>300</sup> collected 11 Arctic species and 6 temperate species and conducted comparison toxicity tests with 2-methyl naphthalene—a component of crude oil known to cause toxic effects. They also found no significant differences in acute toxicity between the Arctic and temperate species. Gardiner et al. found no acute toxicity differences between Arctic species (two Arctic fish larvae and an Arctic copepod) and their temperate cousins exposed to crude oil as well.<sup>301</sup>

This evidence is based on acute studies only and each research team noted that chronic studies are needed. However, a Norwegian Research Council study reviewed 10 years of research on long-term environmental effects of the oil and gas industry and concluded that Arctic organisms themselves are not necessarily more sensitive to oil discharges than temperate organisms.<sup>302</sup>

### **Biodegradation**

Dispersants are designed to break a surface oil slick into small oil droplets less than 70 microns in diameter. This dramatically increases the surface area available for microbial biodegradation. Petroleum-degrading microbes exist in all marine environments including the Arctic<sup>303,304,305,306</sup> and they colonize and begin degrading dispersed oil droplets within a few days after they form.<sup>307,308</sup> Dispersed oil dilutes within hours to concentrations below those that would exhaust natural levels of biologically available oxygen and nutrients needed to support efficient oil biodegradation.<sup>309,310,311</sup> The combination of increased surface

area and dilution allows dispersed oil to efficiently biodegrade in all marine environments including the Arctic.

Lab-based biodegradation studies are used to assess the potential for crude oil to biodegrade in the marine environment. Unfortunately, most published biodegradation studies used concentrations of dispersed oil that were unrealistically high. Dispersed oil concentrations used in published biodegradation studies ranged from 83 ppm (parts per million) to 4,500 ppm.<sup>312</sup> Average concentrations over the multiple days to weeks that it takes for biodegradation to complete are expected to be well below 1 ppm because of the dilution that occurs in an open marine environment.<sup>313</sup> Studying dispersed oil biodegradation at concentrations multiple orders of magnitude higher than is possible in the field has led to biased findings and usually negative bias. Recent testing found that dispersed crude oil at 2.5 ppm was rapidly and extensively biodegraded.<sup>314,315</sup>

To investigate the rate of oil biodegradation under colder climate conditions, Venosa and Holder studied the biodegradation of dispersed Alaska North Slope crude oil at 5°C and 20°C.<sup>316</sup> They found rapid and only slightly reduced biodegradation rates at 5°C compared to 20°C. McFarlin also demonstrated that biodegradation of fresh and weathered Alaska North Slope crude oil using Arctic microorganisms took place at both 2°C and -1°C.<sup>317</sup> Addition of the dispersant Corexit 9500 enhanced the oil degradation process. These results support the findings by Brakstad and Bonaunet<sup>318</sup> that crude oil is degradable by indigenous microorganism populations in Arctic marine environments, even at near-freezing temperatures, although at slower rates compared to higher temperatures.<sup>319,320</sup> In addition, studies conducted by Hazen et al.<sup>321</sup> and Brakstad<sup>322</sup> provide evidence that biodegradation of dispersed oil readily occurs at temperatures similar to those in Arctic waters.

### **Impacts from In-Situ Burning**

The primary concerns for ISB are the potential impacts of the smoke plume and toxicity of the unburned residue. Studies of the emission levels from experimental burns have shown that about 85 to 95% of the burned oil becomes carbon dioxide and water, 5 to 15% of the oil is not burned efficiently and is converted to particulates, mostly soot, and the

remaining, 1 to 3%, is composed of other combustion by-products (e.g., nitrogen dioxide, sulphur dioxide, carbon monoxide, and poly aromatic hydrocarbons). The burn residue from a typical in-situ burn of crude oil is of a semisolid, tar-like consistency and is not readily bioavailable.<sup>323</sup>

Two programs studied the potential environmental effects of ISB in the 1990s. These programs looked at various aspects of smoke emissions and soot production.<sup>324,325,326</sup> Studies that also examined the burn residue showed the low acute toxicity of the burn residue to salt water, freshwater, and benthic species.<sup>327,328</sup> In two known cases, the Haven spill in Italy in 1991 and the Honam Jade spill in South Korea in 1983, sunken burn residues affected benthos and interrupted fishing activities in a relatively localized area due to concerns over contamination of fishing gear.<sup>329,330</sup>

The smoke produced during in-situ burning and the concentrations of particles within this plume that are small enough to be inhaled are usually of most concern to the public. In addition smoke plumes are also of concern because they obstruct visibility and may pose a safety hazard to ships and aircraft. The smoke plume may also result in limited aesthetic impacts. By establishing exclusion zones these adverse effects of in-situ burn activities are easily managed. It is unlikely that these potential impacts will prevent in-situ burn operations in the Arctic due to the relatively low population densities in these areas.<sup>331</sup>

## **OIL SPILL RESPONSE FIELD RELEASE EXPERIMENTS**

### **Introduction and Background**

Oil spill response researchers in the public and private sectors and manufacturers have spent many decades developing, testing, evaluating, and refining response tools and methods for Arctic operations, and these efforts have increased in recent years. Experimental field releases are a logical key step in the development and validation of oil spill containment, recovery, and treatment equipment and methods. Unfortunately, field trials are not consistently conducted and as many as 15 years can lapse between tests. What is needed is a consistent and collaborative approach to experimental field releases to allow industry and federal agencies to prove oil spill response capabilities in the Arctic, test new response tools, test theory and models associated

with oil behavior in the ice environment, and train Arctic responders. A collaborative approach between industry, government, and academic researchers will increase stakeholder confidence in Arctic oil spill contingency plans and allow responders to select the most effective and environmentally acceptable methods for spill response. The knowledge and best practices gained through experimental field releases are a necessary step in the process of continuously improving Arctic spill response plans. As commercial activities increase in the Arctic, industry and federal agencies will need to continue to develop robust oil spill response capabilities that can efficiently operate in harsh environments.

Research into Arctic oil spill response began more than 40 years ago, and significant efforts continue today by industry (either by individual companies or through joint industry projects), academia, and the federal government.<sup>332,333</sup> There have been few actual accidental spills of significant size in Arctic conditions, so the main source of knowledge on oil behavior and spill countermeasures has come from experimental studies in laboratories, test tanks, and field trials or by extrapolating knowledge from spills in temperate regions.

Experimental field releases started in the 1970s and includes work done mostly in Canada, Norway, and some in the United States; however, Arctic releases are scarce. There are a number of reviews and assessments that provide more details on these studies.<sup>334,335,336,337</sup> The last Arctic experimental release in the United States occurred at Prudhoe Bay in 1982.<sup>338</sup> The last experimental release of oil into marine ice in North America took place off the Canadian East Coast in 1986.<sup>339</sup> Three small releases (200 liters each) took place in ice in the Saint Lawrence Estuary in 2008.<sup>340</sup> Norway has since conducted more recent experimental releases, for example, in 2006, 2008, and 2009.<sup>341,342</sup> Findings have demonstrated that laboratory and test tank results can be scaled up and applied safely to large-scale field settings. Large wave basins provide the best alternative to field trials, but they have significant limitations.

A collaborative approach is important for experimental field releases as these activities are complex and costly, and benefit the most from the broadest base of expertise and knowledge. Therefore, industry will continue to attempt to work closely with

federal agencies, indigenous people, local residents, and other stakeholders to conduct experimental field releases. Prior field trials prove that they can be conducted safely and with minimum impact to the environment.

The BSEE maintains the world's largest wave tank dedicated to oil spill response research and training in New Jersey. Known as the National Oil Spill Response Research & Renewable Energy Test Facility or Ohmsett (Oil and Hazardous Materials Simulated Environmental Test Tank), it provides near full-scale test capability and is an excellent venue for some research. Ohmsett, however, cannot fully simulate Arctic field conditions. Without climate control features, Ohmsett can simulate cold water and broken ice conditions and has successfully done so while testing mechanical recovery equipment and dispersants; it cannot fully simulate Arctic conditions. As a result, there is a very small time window when it is practical to maintain ice in the tank for a useful test duration.

Industry and the U.S. federal government need to collaborate on oil spill response research as much as possible, including performing the research with international partners. Some environmental groups have expressed support for these releases to be conducted. There are two key requirements for enabling experimental field releases in the U.S. Arctic. One is a more guaranteed path to a permit assuming a straightforward set of permitting conditions are met. Previous permits for offshore field releases have not been granted just prior to the planned release date after many months of preparation. The second requirement relates to liability. Researchers in the U.S. face potential liability from actual or perceived environmental impacts of a planned field release. The uncertainty of this liability makes industry extremely hesitant to conduct field releases. A solution would be for a U.S. federal agency or agencies (like Inter-agency Coordinating Committee for Oil Pollution Research) to hold the permits and limit the liability from the field release.

Controlled field releases are an important step in the process of developing and proving oil spill response methods in the Arctic. A few releases in the Arctic have been conducted in the past, but time periods between tests can be as long as 15 years. Industry will need a more certain permitting process, collaboration with academic and government

researchers, communication with stakeholders, and a method of controlling liability before additional Arctic field tests can be completed in the United States. There are concerns and challenges associated with carrying out experimental field releases in any location. These concerns and challenges are even greater in the Arctic. Working with stakeholders and governments at the national, regional, and local level to ensure the studies are carried out in a way that protects the environment and the safety of local communities at all stages from planning to execution is critical. The ultimate goal is to develop Arctic oil spill response tools, strategies, and personnel that are as robust and capable as possible, and the consistent execution of experimental field releases is key to reaching this goal.

### Field Release Experiment Objectives

The following list provides some important reasons for conducting experimental field releases:

- To validate lab and basin scale testing that demonstrates the effectiveness of various response strategies (existing, enhancements to existing, and new)
- To validate lab/basin scale testing and model predictions of the fate and effects of oil in the Arctic environment and to collect data needed to assess

environmental impacts and Net Environmental Benefit Analysis considerations

- To demonstrate the technical and operational viability, timeframes, and safety of different techniques
- To advance fundamental scientific knowledge about the Arctic ecosystem
- To engage stakeholders and educate responders on the capabilities and trade-offs of different response strategies
- To provide important training opportunities for Arctic oil spill responders.

### Historical Field Release Experiments

Table 8-2 summarizes most of the medium- to large-scale experimental crude oil spills known to have been conducted in sea ice, regardless of location. Also included are two significant shoreline projects involving experimental releases and long-term monitoring. There may be other experiments, for example in Russia that are not included because project reports and publications are not available. These studies are reviewed and summarized by SL Ross et al.,<sup>343</sup> Brandvik,<sup>344</sup> Fingas and Holleb,<sup>345</sup> and Dickins and Fleet.<sup>346</sup>

Field Experiment	Location	Year
Behavior of Oil Spills in the Arctic	Chukchi Sea	1970
Crude Oil Behavior on Arctic Winter Ice	Beaufort Sea, U.S.	1972
Interaction of Crude Oil with Arctic Sea Ice	Beaufort Sea, Canada	1975
Oil Behavior Under Multi-Year Ice	High Arctic, Canada	1978
Oil and Gas Under Sea Ice	Beaufort Sea, Canada	1979/80
Oil Migration and Modification Processes in Solid Sea Ice	Beaufort Sea, U.S.	1979/80
Physical Interaction and Clean-Up of Crude Oil with Slush and Solid First-Year Ice	Beaufort Sea, U.S.	1980/81
The Baffin Island Oil Spill Project	Baffin Island, Canada	1980, 1983
Emulsions in Ice	Beaufort Sea, Canada	1982
Experimental Releases of Crude Oil in Pack Ice	Nova Scotia, Canada	1986
Marginal Ice Zone Experiment	Barents Sea, Norway	1993
In-situ Cleanup of Oiled Shorelines; Svalbard Shoreline Project	Svalbard	1997
Svalbard Experimental Release 2006	Svalbard	2006
Joint Industry Program on Oil Spill Contingency for Arctic and Ice-Covered Waters: Oil in Ice Field Experiments 2008 and 2009	Barents Sea, Norway	2008, 2009

**Table 8-2.** Summary of Field Experiments in Arctic Conditions

## Performing Field Experimental Releases

Field experiment releases can be performed to research a variety of technical and operational challenges in the areas of: dispersants, in-situ burning, mechanical recovery, natural attenuation, remote sensing, trajectory modeling, and environmental impacts. Depending on the needs of the different projects, releases could involve oil spilled under ice, in the water between floes or, in some cases, on the ice surface. Justification for why the data can only be collected in the field will be provided for the final suite of studies selected for field research. In addition, specific response strategies and data collection methods will receive prior validation in laboratory or basin tests before going into the field.

Planning and executing a field experimental release can be complex but very achievable. Challenges to carrying out this work in remote areas include logistics, planning, and the permitting process. The challenges can be met by:

- Laboratory and mesoscale data to fully confirm the technical feasibility of any response strategy or technology being considered for use in the field
- Meticulous planning with contingencies in priority areas identified through risk analysis and environmental assessment
- Ice and weather forecasting and hindcast analysis to pick the optimum time and place to meet experimental objectives
- Logistics to coordinate multiple marine, air, and space assets, including vessels, aircraft, helicopters, satellites
- Early outreach, consultation, and dialogue with agencies, regulators, local community leaders, and other key stakeholders, and continued communications with stakeholders, project teams, and field teams.

Before any field experimental release can occur, a sequence of assessment, deliberation, community visits, conversations, and formal permit applications needs to take place. The exact order and scope of these activities and expected timing varies by country but at a minimum is expected to include:

- Initial consultation with key agencies, regulators, and indigenous and local community leaders/

members before committing to a formal application process

- Initial evaluation to identify geographic areas that meet the necessary criteria
- Initial research scope and definition
- Detailed project planning including logistics, personnel, contractors, securing support-in-kind, response equipment, costing, scheduling, etc.
- Interim consultation meeting with key agencies, regulators, and indigenous and local community leaders to discuss project plan
- Necessary permit applications completed and submitted to concerned agencies at national, state, and local levels
- Follow-up meetings to answer questions and provide supplementary information
- Provisional go-ahead and agreement in principle
- Final field activity plans and contracts in place to carry out the field experiment research.

Measures that can significantly reduce and mitigate risks associated include:

- Oil spill response strategies to remove as much oil as is practical from the marine environment, including flexible options to cope with changing conditions
- Environmental Assessment (EA) conducted as part of the permit application to ensure important environmental sensitivities are identified and taken into account in the project design and spill contingency plan
- Backup plans to deal with a range of outcomes, such as equipment breakdown and changing weather and ice conditions, including parameters of when to stop the test if conditions are not appropriate
- Monitoring plan to ensure that releases take place away from sensitive wildlife resources and that any residual oil causes no harm
- Having an onboard environmental observer with knowledge of the local area
- Communications plans that maintain full transparency throughout the planning and consultation process and maximize opportunities for key stakeholders to view the releases first-hand if possible.

External stakeholder involvement at the outset of the planning process is critical to ensuring all parties

are involved in a conversation about what is being proposed, how it will be carried out, and how people can become actively involved. The field releases will afford local communities an opportunity to witness the application of a range of response strategies in their own environment and to gain confidence in industry capabilities. Examples of this involvement may include:

- *Planning.* Including indigenous peoples' traditional knowledge on the marine environment, ecosystems, and subsistence harvesting is critical to the environmental assessment process and operational planning.
- *Education.* The field releases provide a unique opportunity for a dialogue regarding practical and scientific knowledge about the latest Arctic spill response methods with regulators and community groups. The release also provides an opportunity for agency and industry personnel to couple the experiment with training elements.
- *Data collection.* This could include monitoring sea ice conditions and wildlife using local hunters.

## RECOMMENDATIONS

### Arctic Well Integrity, Spill Prevention Methods, and Technology

**Well Integrity Recommendation 1.** A joint industry and U.S. government study is recommended to develop a methodology to quantify the risks and benefits of the multiple barrier technologies, using appropriately detailed reliability data and assessments. The goal of this study is to achieve source control of the well in the most rapid manner to minimize the potential spill volume. The study should consider overall acceptability of risk levels, contribution of different risk mitigation practices, and other mitigations to risks that could be incorporated into Arctic operations. This risk-based methodology could then be used as a basis to determine the suitable barrier requirement to prevent loss of well control and thus serve as a performance-based requirement as opposed to the prescriptive requirements. If this methodology shows that environmental risks from the use of alternative barrier approaches are less than a same season relief well (SSRW), then SSRW and perhaps other spill response requirements could be eliminated for appropriate wells. This would extend the drilling season and facilitate exploration and development.

Practices in assessment techniques from the nuclear, aviation, and petrochemical industries such as accident sequence precursor analysis could be applied.<sup>347</sup>

**Well Integrity Recommendation 2.** Industry is leading efforts to enhance well capping and shut-off technology. Identification and development of technologies that can lead to material advancements (e.g., reliability, speed, and practicality) are potential areas for industry and government collaboration.

### Arctic Oil Spill Response

**Oil Spill Response Recommendation 1.** Support policy that elevates all oil spill response tools (mechanical recovery, dispersants, in-situ burning, and any new/improved technology that is developed) to primary options. Decisions concerning which option should be used in an emergency to minimize environmental impact will be based on Net Environmental Benefit Analysis (NEBA). Regulatory credit for all these tools should be provided when calculating how much equipment must be included in the Oil Spill Response Plan to meet worst-case discharge requirements (both at the federal and Alaska level).

**Oil Spill Response Recommendation 2.** The Department of Energy (DOE), other federal agencies, and the state of Alaska should support preapproval use of dispersants and in-situ burning by the Alaska Regional Response Team for all offshore Outer Continental Shelf Alaska. Decisions regarding preapproval should be based on sound science, including past and ongoing research on fates and effects of dispersant-treated oil in the Arctic environment and on toxicity tests of dispersant-treated oil at realistic concentrations and exposures and at appropriate temperatures and salinities. Preapproval should be based on a NEBA-based approach that includes input by industry, Oil Spill Response organizations, academia, and other stakeholders.

**Oil Spill Response Recommendation 3.** The NEBA-based decision process should be used in a collaborative process by government (federal, state, and local) decision-makers, academia, responders, local communities, and industry to select and assess the response options that offer the greatest overall reduction of environmental impacts. This NEBA-based decision-making process should be conducted for relevant Alaska Arctic regions to identify future preapproval zones for dispersants and in-situ burning. If

studies are required to support the NEBA process, DOE, other governmental entities such as National Oceanic and Atmospheric Administration and Alaska Department of Environmental Conservation, and industry should collaboratively perform them (such as the University of Alaska's study) taking into account local knowledge. This recommendation was also supported in the NRC 2014 study.

***Oil Spill Response Recommendation 4.*** Support the need for additional remote sensing research to enhance the ability to detect and track an oil spill in ice, including scenarios that result in oil under, trapped within, or on top of the ice. DOE and their National Laboratories should collaborate with industry to determine if any existing military technology or other research in the area of remote sensing, including satellites, can be made available and commercialized for oil spill response use. A key consideration for this research is the need for as close to real-time information as possible.

***Oil Spill Response Recommendation 5.*** ICCOPR (Interagency Coordinating Committee on Oil Pollution Research, which is composed of 15 agencies) should support the issuance of timely permits (1 year or less) to conduct Arctic oil release field experiments with lead agencies coordinating and championing the issuance of the permits. In compliance with statutory and permitting requirements, ICCOPR should encourage and facilitate controlled experimental releases of oil for offshore spill response R&D and equipment testing in coordination with regional response teams. Agencies should also include international cooperation in this area; in the past, the United States has participated and been invited to participate in controlled experimental releases in other countries such as Norway and Canada. Large-scale basin experiments to validate new technologies and strategies often precede field experiments. In that regard, continued support is recommended for the operation and maintenance of Ohmsett (BSEE's National Oil Spill Response Test Facility, located in New Jersey) and any enhancements to facilitate more Arctic testing.

***Oil Spill Response Recommendation 6.*** Support ICCOPR as the federal body for prioritizing oil spill research. ICCOPR is designated under the Oil Pollution Act of 1990 as the means to leverage efforts of federal agencies engaged in research affecting off-

shore oil spill response. ICCOPR should play a strong role in conducting and/or supporting oil spill response research and technology development, both nationally and internationally, with adequate long-term support. Priorities for oil spill research should take into account available science and past and present research efforts, leverage existing joint agreements, and be addressed through a comprehensive, coordinated effort that links industry, government (federal and state), academia, oil spill removal organizations, international and local experts, and nongovernmental organizations. Interagency partners should collaborate with industry experts/consultants to evaluate selected oil spill response equipment and tactics and utilize this information to inform planning tools and requirements and regulatory changes. ICCOPR should hold regular informational/educational sessions with support by industry and oil spill response (OSR) organizations.

***Oil Spill Response Recommendation 7.*** The National Laboratories should work with industry to develop an oil simulant(s) that can be used for field testing. The simulant(s), to the extent possible, needs to represent the properties of crude oil critical to testing remote sensing technologies, mechanical recovery, in-situ burning, and dispersants.

***Oil Spill Response Recommendation 8.*** DOE should support development of communications strategies that explain the capability of Arctic oil spill planning, preparedness, and response to government agencies (federal and state), industry, stakeholders, and the public. The communications should include issues such as ongoing and existing oil spill response research and science and rapid communication during an incident. Regulators and industry need to align on oil spill response expectations and ensure the public is informed.

***Oil Spill Response Recommendation 9.*** DOE and other agencies should support the process to obtain long-term permits for use of unmanned aircraft. These tools are capable of carrying multiple sensors and are small enough to be flown from response vessels. Unmanned aircraft will also expand the capabilities for 24-hour surveillance and complements the use of manned aircraft. Unmanned aircraft have much more flexibility than manned systems, but most important of all, they reduce exposure of pilots to flights in potentially hazardous conditions.

## REFERENCES

- 1 ExxonMobil, Arctic Leadership brochure, ExxonMobil Corporation, Irving, Texas, May 2008.
- 2 Masterson, D. and Baudais, D., *The Arctic Island Adventure and Pan-Arctic Oils Ltd*, The Society of Naval Architects and Marine Engineers, Arctic Section, Calgary, Alberta, Canada, April 2010.
- 3 Timco, G.W. and Frederking, R., *Overview of Historical Canadian Beaufort Sea Information*, Technical Report CHC-TR-057, Canadian Hydraulics Centre, National Resource Council of Canada, Ottawa, Ontario, Canada, February 2009.
- 4 ExxonMobil, Arctic Leadership brochure, ExxonMobil Corporation, Irving, Texas, May 2008.
- 5 Timco, G.W. and Frederking, R., *Overview of Historical Canadian Beaufort Sea Information*, Technical Report CHC-TR-057, Canadian Hydraulics Centre, National Resource Council of Canada, Ottawa, Ontario, Canada, February 2009.
- 6 Masterson, D. and Baudais, D., *The Arctic Island Adventure and Pan-Arctic Oils Ltd*, The Society of Naval Architects and Marine Engineers, Arctic Section, Calgary, Alberta, Canada, April 2010.
- 7 API Specification 5CT, *Specification for Casing and Tubing*, American Petroleum Institute, Washington, D.C., 9th Edition, July 2011.
- 8 Federal Register, Part III, Department of the Interior, Bureau of Ocean Energy Management, Regulation and Enforcement, 30 CFR Part 250, "Oil and Gas and Sulphur Operations in the Outer Continental Shelf – Increased Safety Measures for Energy Development on the Outer Continental Shelf; Final Rule," National Archives and Records Administration, Washington, D.C., October 14, 2010.
- 9 API RP 65-2, *Isolating Potential Flow Zones During Well Construction*, American Petroleum Institute, Washington, D.C., 2nd Edition, December 2010.
- 10 Federal Register, Part III, Department of the Interior, Bureau of Ocean Energy Management, Regulation and Enforcement, 30 CFR Part 250, "Oil and Gas and Sulphur Operations in the Outer Continental Shelf – Increased Safety Measures for Energy Development on the Outer Continental Shelf; Final Rule," National Archives and Records Administration, Washington, D.C., October 14, 2010.
- 11 API Standard 53, *Blowout Prevention Equipment Systems for Drilling Wells*, American Petroleum Institute, Washington, D.C., 4th edition, November 2012.
- 12 API RP 75, *Development of a Safety and Environmental Management Program for Offshore Operations and Facilities*, American Petroleum Institute, Washington, D.C., 3rd Edition, May 2004.
- 13 Rassenfoss, Stephen, "Well Capping Becomes an Industry of Its Own," *Journal of Petroleum Technology*, Society of Petroleum Engineers, Volume 65, Number 7, pp. 40-47, July 2013.
- 14 Chevron Canada Limited, "An Approach to Oil Spill Containment for Floating Drilling Operations in Canadian Beaufort Sea Pack Ice Conditions," Canada-US Northern Oil and Gas Research Forum, Calgary, Alberta, December 2010.
- 15 Izon, David, Danenberger, E.P., and Mayes, Melinda, "Absence of Fatalities in Blowouts Encouraging in MMS Study of OCS Incidents 1992-2006," *Drilling Contractor*, pp. 84-90, July/August 2007.
- 16 Danenberger, E.P., *Outer Continental Shelf Drilling Blowouts, 1971-1991*, OTC #7248, 25th Annual Offshore Technology Conference, Houston, Texas, May 1993.
- 17 Federal Register, Part III, Department of the Interior, Bureau of Ocean Energy Management, Regulation and Enforcement, 30 CFR Part 250, "Oil and Gas and Sulphur Operations in the Outer Continental Shelf – Increased Safety Measures for Energy Development on the Outer Continental Shelf; Final Rule," National Archives and Records Administration, Washington, D.C., October 14, 2010.
- 18 NTL No. 2010-N06, "MMS Notice to Lessees NTL No. 2010-N06," United States Department of the Interior, Minerals Management Services, Washington, D.C., June 18, 2010.
- 19 NTL No. 2010-N10, "National Notice to Lessees and Operators (NTL) of Federal Oil and Gas Leases," NTL No. 2010-N10, Outer Continental Shelf, United States Department of the Interior, Bureau of Ocean Energy Management, Regulation and Enforcement, Washington D.C., November 8, 2010.
- 20 API Standard 53, *Blowout Prevention Equipment Systems for Drilling Wells*, American Petroleum Institute, Washington, D.C., 4th edition, November 2012.
- 21 Cooke, Roger M., Ross, Heather L., and Stern, Adam, *Precursor Analysis for Offshore Oil and Gas Drilling*, Resources for the Future, RFF DP 10-61, Washington, D.C., January 2011.
- 22 Arctic Council. 2009. *Arctic Marine Shipping Assessment 2009 Report*. 2nd printing.
- 23 Sørstrøm, S. E., P.-J. Brandvik, I. Buist, P. Daling, D. Dickins, L.-G. Faksness, S. Potter, J. F. Rasmussen, and I. Singaas. 2010. *Joint Industry Program on Oil Spill Contingency for Arctic and Ice-covered Waters: Summary Report*. SINTEF Oil in Ice JIP, Trondheim, Norway.
- 24 DF Dickins Associates Ltd. and Fleet Technology Limited. 1992. *Behaviour of spilled oil at sea (BOSS): Oil-in-ice fate and behavior*. Draft report submitted to Environment Canada, U.S. Minerals Management Service and American Petroleum Institute.
- 25 Fingas, M. F. and B. P. Hollebone. 2002. *Behaviour of Oil in Freezing Environments: A Literature Review*. Arctic and Marine Oilspill Program Technical Seminar, Environment Canada.
- 26 Dickins, D. and Buist, I. 1999. Oil Spill Countermeasures for Ice Covered Waters. *Journal of Pure and Applied Chemistry*, Vol. 71, No. 1, London, 1999.
- 27 SL Ross. 2010. *Evaluation of the Crucial Coated-Disk Skimmer in Arctic Conditions*. Report to Alaska Clean Seas.
- 28 Potter, S., I. Buist, K. Trudel, D. Dickins, and E. Owens. February 2012. *Spill Response in the Arctic Offshore*. Prepared for the American Petroleum Institute and the Joint Industry Programme on Oil Spill Recovery in Ice, D. Scholz (ed.). American Petroleum Institute, Washington. pp. 157.
- 29 Dickins, D. F. 2011. *Behavior of Oil Spills in Ice and Implications for Arctic Spill Response*. Arctic Technology Conference, Houston, TX, Offshore Technology Conference.
- 30 Sørstrøm, S. E., P.-J. Brandvik, I. Buist, P. Daling, D. Dickins, L.-G. Faksness, S. Potter, J. F. Rasmussen, and I. Singaas. 2010. *Joint Industry Program on Oil Spill Contingency for Arctic and Ice-Covered Waters: Summary Report*. SINTEF Oil in Ice JIP, Trondheim, Norway.
- 31 Mullin, J. 2012. "The Oil and Gas Industry's Commitment to Responsible Arctic Operations: An Innovative Arctic Oil Spill Response Technology" - Joint Industry Program. OTC Paper 23800, *Proceedings Offshore Technology Conference*, Houston, TX.
- 32 SL Ross Environmental Research Ltd., DF Dickins Associates Ltd., and Envision Planning Solutions Inc. 2010. *Beaufort Sea Oil Spills State of Knowledge Review and Identification of Key Issues*. Environmental Studies Research Funds Report No. 177. Calgary. pp. 126.
- 33 Potter, S., I. Buist, K. Trudel, D. Dickins, and E. Owens. 2012. *Spill Response in the Arctic Offshore*. Prepared for the American Petroleum

- Institute and the Joint Industry Programme on Oil Spill Recovery in Ice, D. Scholz (ed.). American Petroleum Institute, Washington.
- 34 National Research Council. 2014. *Responding to Oil Spills in the Arctic*. National Academies Press, Washington, D.C.
  - 35 Potter, S., I. Buist, K. Trudel, D. Dickins, and E. Owens. 2012. *Spill Response in the Arctic Offshore*. Prepared for the American Petroleum Institute and the Joint Industry Programme on Oil Spill Recovery in Ice, D. Scholz (ed.). American Petroleum Institute, Washington.
  - 36 Federal Interagency Solutions Group. Nov 2010. Oil Budget Calculator – Deepwater Horizon. Report to the National Incident Command.
  - 37 Bronson, M., Thompson, E., McAdams F., and J. McHale. 2002. Ice Effects on Barge-based Oil Spill Response Systems in the Alaskan Beaufort Sea. *Proceedings 25th Arctic and Marine Oilspill Program Technical Seminar (AMOP)*, Calgary, pp. 1253-1268.
  - 38 Potter, S., I. Buist, K. Trudel, D. Dickins, and E. Owens. February 2012. *Spill Response in the Arctic Offshore*. Prepared for the American Petroleum Institute and the Joint Industry Programme on Oil Spill Recovery in Ice, D. Scholz (ed.). American Petroleum Institute, Washington. pp. 157.
  - 39 Schmidt, B., P. Meyer, and S. Potter. 2014. Testing of Oil Recovery Skimmers in Ice at Ohmsett. *Proceedings The 37th AMOP Technical Seminar on Environmental Contamination and Response*, Canmore, AB.
  - 40 National Research Council. 2014. *Responding to Oil Spills in the Arctic*. National Academies Press, Washington, D.C.
  - 41 Chevron Canada Limited. 2011. Arctic Offshore Drilling Review Submission Part 2: Responses to NEB Calls for Information 1 and 2. National Energy Board - Public Review of Arctic Safety and Environmental Offshore Drilling Requirements. NEB File No. OF-EP-Gen-AODR 01.
  - 42 Lampela, K. 2007. Baltic approach to oil spill recovery in ice: case studies and recent development in Baltic Sea States. *Proceedings International Oil & Ice Workshop*. 2007. Minerals Management Service. Herndon, VA.
  - 43 Bergström, R. 2012. Lessons learned - the Godafoss accident in Feb. 2011: Oil spill recovery at -20°C. *Proceedings Interspill Conference*, London.
  - 44 Ibid.
  - 45 National Research Council. 2014. *Responding to Oil Spills in the Arctic*. National Academies Press, Washington, D.C.
  - 46 Brown, H. M. and R. H. Goodman. 1996. The use of dispersants in broken ice. *Proceedings of the nineteenth Arctic and marine oil-spill program (AMOP) Technical Seminar*, Canada, Environment Canada.
  - 47 Spring, W., T. Nedwed, and R. Belore. 2006. Icebreaker enhanced chemical dispersion of oil spills. *Proceedings of the 29 Arctic and Marine Oilspill Program (AMOP) Technical Seminar*, Canada, Environment Canada.
  - 48 Nedwed, T., R. Belore, W. Spring, and D. Blanchet. 2007. Basin scale testing of ASD icebreaker enhanced chemical dispersion of oil spills. *Proceedings of the AMOP Technical Seminar on Environmental Contamination and Response*, Environment Canada, Edmonton, AB.
  - 49 Mullin, J., R. Belore, and K. Trudel. 2008. Cold water dispersant effectiveness experiments conducted at OHMSETT with Alaskan crude oils using Corexit 9500 and 9527 dispersants. *Proceedings of the 2008 International Oil Spill Conference*, May 4-8, 2008, Savannah, Georgia. American Petroleum Institute, Washington, D.C. pp. 817-822.
  - 50 Owens, C. K. and R. S. Belore. 2004. Dispersant effectiveness testing in cold water and brash ice. *Proceedings of the 27 Arctic and Marine Oilspill Program (AMOP) Technical Seminar (V2)*, Canada, Environment Canada.
  - 51 Venosa, A.D. and E.L. Holder. 2013. Determining the dispersibility of South Louisiana crude oil by eight oil dispersant products listed on the NCP Product Schedule. *Marine Pollution Bulletin* 66: 73-77.
  - 52 Nedwed, T., R. Belore, W. Spring, and D. Blanchet. 2007. Basin-scale testing of ASD icebreaker enhanced chemical dispersion of oil spills. *Proceedings of the AMOP Technical Seminar on Environmental Contamination and Response*, Environment Canada, Edmonton, AB.
  - 53 Gardiner WW, Word JQ, Word JD, Perkins RA, McFarlin K, Hester BW, Word LS, and Ray CM. 2013. The acute toxicity of chemically and physically dispersed crude oil to key Arctic species under Arctic conditions during the open water season *Environ Toxicol Chem* 32:2284-2300.
  - 54 Daling, P., P.J. Brandvik, F. Leirvik, A. Holumsnes, and C. Rasmussen. 2010. Development and field testing of a flexible system for application of dispersants to oil spills in ice. *Proceedings 33rd Arctic and Marine Oilspill Program Technical Seminar*, Halifax NS, pp. 787-814.
  - 55 Nedwed, T., W. Spring, R. Belore, and D. Blanchet. 2007. Basinscale testing of ASD icebreaker enhanced chemical dispersion of oil spills. *Proceedings Arctic and Marine Oilspill Program (AMOP) Technical Seminar*. No. 30, Vol. 1, pp. 151-160. Environment Canada, Ottawa, Canada.
  - 56 Daling, P., P.J. Brandvik, F. Leirvik, A. Holumsnes, and C. Rasmussen. 2010. Development and field testing of a flexible system for application of dispersants to oil spills in ice. *Proceedings 33rd Arctic and Marine Oilspill Program Technical Seminar*, Halifax NS, pp. 787-814.
  - 57 National Research Council. 2014. *Responding to Oil Spills in the Arctic*. National Academies Press, Washington, D.C.
  - 58 Brandvik, P.-J., O. Johansen, and U. Farooq. 2013. Droplet breakup in subsea oil releases – Part 1: Experimental study of droplet breakup and effectiveness of dispersant injection. *Marine Pollution Bulletin* 73(1): 319-326.
  - 59 Johansen, O., P.-J. Brandvik, and U. Farooq. 2013. Droplet breakup in subsea oil releases – Part 2: Predictions of droplet size distributions with and without injection of chemical dispersants. *Marine Pollution Bulletin* 73(1): 327-335.
  - 60 National Research Council. 2014. *Responding to Oil Spills in the Arctic*. National Academies Press, Washington, D.C.
  - 61 McMinn, T.J. 1972. *Crude Oil Behavior on Arctic Winter Ice: Final Report*. Office of Research and Development, United States Coast Guard, Project 734108, Wash. D.C., NTIS Publication No. AP-754, p. 261 (also published as McMinn, LTJG T.J. 1973. *Oil Spill Behavior in a Winter Arctic Environment*. Offshore Technology Conference, Houston).
  - 62 NORCOR. 1975. *The Interaction of Crude Oil with Arctic Sea Ice: Beaufort Sea Project* Technical Report No. 27. Fifth Arctic Marine Oil Spill Program Technical Seminar. Department of the Environment. Victoria, BC, Canada.
  - 63 Dickins, D.F. and I.A. Buist. 1981. *Oil and Gas Under Sea Ice Study: Vols. 1&2*. Prepared by Dome Petroleum Ltd. for COOSRA, Report CV-1, Calgary, AB, Canada (also published in *Proceedings 1981 Oil Spill Conference*, Atlanta GA).

- 64 Buist, I. and D. Dickins. 1987. Experimental spills of crude oil in pack ice. *Proceedings 1987 International Oil Spill Conference*. American Petroleum Institute. Washington.
- 65 Allen, A.A. 1990. Contained Controlled Burning of Spilled Oil During the Exxon Valdez Oil Spill. *Proceedings of the Arctic and Marine Oilspill Program Technical Seminar*. No. 13, Environment Canada, Ottawa. pp. 305-313.
- 66 Dickins, D.F., P.J. Brandvik, J. Bradford, L.-G. Faksness, L. Liberty, and R. Daniloff. 2008. *Svalbard 2006 experimental oil spill under ice: Remote sensing, oil weathering under Arctic conditions and assessment of oil removal by in-situ burning*. Presented at the 2008 International Oil Spill Conference, Savannah, GA.
- 67 Alaska Regional Response Team. 2008. In-Situ Burning Guidelines for Alaska: Revision 1. Appendix II, Annex F, in *The Alaska Federal/State Preparedness Plan for Response to Oil and Hazardous Substance Discharges/Releases*.
- 68 Alaska Department of Environmental Conservation, U.S. Environmental Protection Agency, and United States Coast Guard. March 2001 (in revision April 2007). *The Alaska Federal/State Preparedness Plan for Response to Oil and Hazardous Substance Discharge/Releases – Unified Plan App II Annex F In-Situ Burning Guidelines for Alaska Rev. 1*, Anchorage, AK.
- 69 Buist, I.A., T. Coe, D. Jensen, S. Potter, L. Anderson, K. Bitting, and K. Hansen. 2003. *In-Situ Burn Operations Manual. U.S. Coast Guard Research and Development Center Report*, CG-D-06-03, Groton, CT.
- 70 Brandvik, P.J., L.-G., Faksness, D.F. Dickins, and J. Bradford. 2006. *Weathering of Oil Spills Under Arctic Conditions: Field Experiments with Different Ice Conditions Followed by In-situ Burning*. Presented at the 2006 Third Annual NATO/CCMS Oil Spill Response Workshop, Oct 11-13, Dartmouth, NS, Canada.
- 71 World Wildlife Fund. 2010. *Drilling for Oil in the Arctic: Too Soon, Too Risky*. World Wildlife Fund, Washington, D.C.
- 72 Goodyear, J. and B. Beach. 2012. *Environmental Risks with Proposed Offshore Oil and Gas Development off Alaska's North Slope*, IP: 12-08-A. National Resources Defense Council.
- 73 Buist, I.A., S.L. Ross, B.K. Trudel, E. Taylor, T.G. Campbell, P.A. Westphal, M.R. Myers, G.S. Ronzio, A.A. Allen, and A.B. Nordvik. 1994. *The Science, Technology and Effects of Controlled Burning of Oil Spills at Sea*. MSRC Technical Report Series 94-013, Marine Spill Response Corporation, Washington, D.C., pp. 382.
- 74 Mabile, N. 2012. *The Coming of Age of Controlled In-Situ Burning: Transition from Alternative Technology to a Conventional Offshore Spill Response Option*. Presentation at Interspill 2012, London, UK.
- 75 Potter S., Buist, I., Trudel K., Dickins D., and Owens E. 2012. *Spill response in The Arctic offshore*, Prepared for the American Petroleum Institute and the Joint Industry Programme on Oil Spill Recovery in Ice.
- 76 Brandvik, Per Johan, Daling, Per Snorre, Faksness, Liv-Guri, Fritt-Rasmussen, Janne, Lundmark Daae, Ragnmark, and Leirvik, Frode. 2010. *Experimental Oil Release in Broken ice – A Large-Scale Field Verification of results from Laboratory Studies of Oil Weathering and Ignitability of Weathered Oil Spills*, Oil-in-Ice Joint Industry Project, Report no. 26. April 20, 2010.
- 77 Allen, A.A. 1990. Contained Controlled Burning of Spilled Oil During the Exxon Valdez Oil Spill. *Proceedings of the Arctic and Marine Oilspill Program Technical Seminar*. No. 13, Environment Canada, Ottawa. pp. 305-313.
- 78 Fingas, M.F., G. Halley, F. Ackerman, R. Nelson, M.C. Bissonnette, N. Laroche, Z. Wang, P. Lambert, K. Li, P. Jokuty, G. Sergy, W. Halley, J. Latour, R. Galarneau, B. Ryan, P.R. Campagna, R.D. Turpin, E.J. Tennyson, J. Mullin, L. Hannon, D. Aurand and R. Hiltabrand. 1995. The Newfoundland offshore burn experiment. *Proceedings 1995 International Oil Spill Conference*, pp. 123-132. American Petroleum Institute. Washington, D.C.
- 79 Allen A.A., D. Jager, N.J. Mabile, and D. Costanzo. 2011. The Use of Controlled Burning during the Gulf of Mexico Deepwater Horizon MC-252 Oil Spill Response. *International Oil Spill Conference Proceedings*, March 2011, Vol. 2011, no. 1, pp. abs194.
- 80 ART. 2014. "Arctic Response Technology Joint Industry Project." from <http://www.Arcticresponsetechnology.org/>.
- 81 Buist, I., Potter, S., and Sørstrøm, S.E. 2010. Barents Sea Field Test of Herder to Thicken Oil for In-Situ Burning in Drift Ice. *Proceedings 33rd AMOP Technical Seminar*, Halifax NS.
- 82 Buist I.A., S. Potter, T. Nedwed, and J. Mullin. 2011. Herding surfactants to contract and thicken oil spills in pack ice for In-Situ burning. SL. Ross Environmental Research, ExxonMobil, and U.S. Department of the Interior (BOEM), *Cold Regions Science and Technology* 67 (2011) 3–23.
- 83 Buist, I.A., S.G. Potter, B.K. Trudel, S.R. Shelnut, A.H. Walker, D.K. Scholz, P.J. Brandvik, J. Fritt-Rasmussen, A.A. Allen, and P. Smith. 24 October 2013. *In-Situ Burning in Ice-Affected Waters: State of Knowledge Report*, Final Report 7.1.1 to the Arctic Response Technology Joint Industry Programme.
- 84 Leifer, I., W.J. Lehr, D. Simecek-Beatty, E. Bradley, R. Clark, P. Denison, H. Yongxiang, S. Matheson, C.E. Jones, B. Holg, M. Reif, D. A. Roberts, J. Sveikovskiy, G. Swayze, and J. Wozencraft. 2012. State of the art satellite and airborne marine oil spill remote sensing: Application to the BP Deepwater Horizon oil spill. Elsevier. *Remote Sensing of Environment* 124: 185-209.
- 85 Dickins, D.F. and J.H.S. Andersen. 2009. *Remote Sensing Technology Review and Screening*. SINTEF Oil in Ice JIP, Report 22.
- 86 Bradford, J. H., D.F. Dickins, and P.J. Brandvik. 2010. Assessing the potential to detect oil spills in and under snow using airborne ground-penetrating radar. *Geophysics* 75(2): G1-G12.
- 87 Wilkinson, J., H. Singh, and T. Maksym. 2012. Information sheet reporting preliminary results from study on locating oil under ice with sonar and cameras. Joint research program between the Scottish Marine Institute, Woods Hole Oceanographic Institute, CRREL and the Prince William Sound Oil Spill Research Institute.
- 88 Wilkinson J., Maksym T., Bassett C., Lavery A., Singh H., Chayes D., Elosegui P., Wadhams, P., Ulrich-Evers, K., and Jochmann P. 2013. *Oil Detection under Sea Ice. Experiments performed in the Experimental Basins at HSVA*. Report to the Alaska Clean Seas.
- 89 Nedwed, T., Srnka, L., and Thomann, H. 2008. Remote Detection of Oil Spilled under Ice and Sno using Nuclear Magnetic Resonance. *Proceedings of the 31st Arctic and Marine Oilspill Program (AMOP) Technical Seminar*. Calgary, AB Canada, Environment Canada: 693-702.
- 90 American Petroleum Institute. 2012. *Spill Response in the Arctic Offshore*, Final report for the American Petroleum Institute and the Joint Industry Programme on Oil Spill Recovery in Ice, Washington D.C., p. 144.
- 91 NORCOR. 1975. *The Interaction of Crude Oil with Arctic Sea Ice: Beaufort Sea Project*, Technical Report No. 27. Fifth Arctic Marine Oil Spill Program Technical Seminar. Department of the Environment. Victoria, BC, Canada.
- 92 Dickins, D.F. and Buist, I.A. 1981. *Oil and Gas Under Sea Ice Study: Vols. 1&2*. Prepared by Dome Petroleum Ltd. for COOSRA, Report CV-1, Calgary, AB, Canada (also published in *Proceedings 1981 Oil Spill Conference*, Atlanta GA).

- 93 Sergy, G. A. and P. J. Blackall. 1987. *Design and Conclusions of the Baffin Island Oil Spill Project* VOL. 40, SUPP. 1 (1987) P. 1-Q ARCTIC.
- 94 Singsaas, I., Brandvik, P.J., Daling, P.S., Reed, M., and Lewis, A. 1994. Fate and Behaviour of Oils Spilled in the Presence of Ice - A comparison of the results from recent laboratory, meso-scale flume and field tests. *Proceedings Arctic and Marine Oilspill Program Technical Seminar*. No. 17, Vol. 1, pp. 355-370. Environment Canada, Ottawa.
- 95 Rytkönen, J. and Sassi J. 2001. *Testing of novel oil recovery units in winter conditions. Sea trials in the Archipelago Sea in March 2001*. Research report VAL34- 012214. Espoo, Finland, 2001.
- 96 Sørstrøm, S. E., P.-J. Brandvik, I. Buist, P. Daling, D. Dickins, L.-G. Faksness, S. Potter, J. F. Rasmussen, and I. Singsaas. 2010. *Joint Industry Program on Oil Spill Contingency for Arctic and Ice-Covered Waters: Summary Report*. SINTEF Oil in Ice JIP, Trondheim, Norway.
- 97 Potter S., Buist, I., Trudel K., Dickins D., Owens E. 2012. *Spill response in the Arctic offshore*, Prepared for the American Petroleum Institute and the Joint Industry Programme on Oil Spill Recovery in Ice.
- 98 Gardiner WW, Word JQ, Word JD, Perkins RA, McFarlin K, Hester BW, Word LS, and Ray CM. 2013. The acute toxicity of chemically and physically dispersed crude oil to key Arctic species under Arctic conditions during the open water season. *Environ Toxicol Chem* 32:2284-2300.
- 99 McFarlin KM, Prince RC, Perkins RA, and Leigh MB. 2014. *Biodegradation of Dispersed Oil in Arctic Seawater at -1°C*. PLOS ONE, Volume 9, Issue 1.
- 100 McFarlin KM, Prince RC, Perkins RA, and Leigh MB. 2014. Oil Biodegradation by Arctic Marine Microorganisms. *Proceedings of the AMOP Technical Seminar on Environmental Contamination and Response*, Environment Canada, Halifax, NS.
- 101 Wilkinson J., Maksym T., Bassett C., Lavery A., Singh H., Chayes D., Elosegui P., Wadhams, P., Ulrich-Evers, K., and Jochmann P. 2013. *Oil Detection under Sea Ice. Experiments performed in the Experimental Basins at HSVA*. Report to the Alaska Clean Seas.
- 102 Palandro, D., T. Nedwed, L. Srnka, H. Thomann, and E. Fukushima. 2013. Using nuclear magnetic resonance in the earth's magnetic field to detect oil under ice. *Proceedings of the AMOP Technical Seminar on Environmental Contamination and Response*, Environment Canada, Halifax, NS.
- 103 Nedwed, T. 2010. New dispersant gel triples capacity of delivery planes and treats high viscosity oils. *Proceedings of the AMOP Technical Seminar on Environmental Contamination and Response*, Environment Canada, Halifax, NS.
- 104 Nedwed, T., R. Belore, W. Spring, and D. Blanchet. 2007. Basinscale testing of ASD icebreaker enhanced chemical dispersion of oil spills. *Proceedings of the AMOP Technical Seminar on Environmental Contamination and Response*, Environment Canada, Edmonton, AB.
- 105 Nedwed T. 2014. Overview of the American Petroleum Institute (API) Joint Industry Task Force – Subsea Dispersant Injection Project. *Proceedings of the International Oil Spill Conference*.
- 106 Wilkman G. W., Uuskallio A., Ritari E., and Niini M. K. 2014. Technological Development in Oil Recovery in Ice Conditions. *Arctic Technology Conference Proceedings*.
- 107 Wilkinson J., Maksym T., Bassett C., Lavery A., Singh H., Chayes D., Elosegui P., Wadhams, P., Ulrich-Evers, K., and Jochmann P. 2013. *Oil Detection under Sea Ice. Experiments performed in the Experimental Basins at HSVA*. Report to the Alaska Clean Seas.
- 108 U.S. Department of the Interior, Minerals Management Service. 2008. *Arctic Oil Spill Response Research and Development Program: A Decade of Achievement*.
- 109 Hansen K. 2014. Evaluating Equipment for responding to oil spills in ice. *Proceedings of the AMOP Technical Seminar on Environmental Contamination and Response*, Environment Canada, Halifax, NS.
- 110 Glaeser, J. L. 1971. *A study of the behavior of oil spills in the Arctic*. Washington, D.C., National Technical Information Service.
- 111 McMinn, T.J. 1973. *Crude oil behaviour on Arctic winter ice*. U.S. Coast Guard Report No. 734108. Washington, D.C.
- 112 NORCOR. 1975. *The Interaction of Crude Oil with Arctic Sea Ice: Beaufort Sea Project* Technical Report No. 27. Fifth Arctic Marine Oil Spill Program Technical Seminar. Department of the Environment. Victoria, BC, Canada.
- 113 Dickins, D. F., I. A. Buist and W. M. Pistruzak. 1981. *Dome's Petroleum Study of Oil and Gas Under Sea Ice*. International Oil Spill Conference, Atlanta, GA.
- 114 Comfort, G. and W. Purves. 1982. *The behaviour of crude oil spilled under multi-year ice*. Ottawa, Canada, Environment Canada Environmental Protection Service.
- 115 Nelson, William G. and A. A. Allen. 1982. The physical interaction and cleanup of crude oil with slush and solid first year sea ice. *Proc. Fifth Arctic and Marine Oil Spill Program Technical Seminar*. Environment Canada. Ottawa.
- 116 Buist, I.A., S.G. Potter, and D.F. Dickins. 1983. Fate and behaviour of water-in-oil emulsions in ice. *Proceedings of the Sixth Arctic Marine Oilspill Program Technical Seminar*. Environment Canada. Ottawa.
- 117 Buist, I. and D. Dickins. 1987. Experimental spills of crude oil in pack ice. *Proceedings 1987 International Oil Spill Conference*. American Petroleum Institute. Washington.
- 118 Singsaas, I., Brandvik, P.J., Daling, P.S., Reed, M., and Lewis, A. 1994. Fate and Behaviour of Oils Spilled in the Presence of Ice - A comparison of the results from recent laboratory, meso-scale flume and field tests. *Proceedings Arctic and Marine Oilspill Program Technical Seminar*. No. 17, Vol. 1, pp. 355-370. Environment Canada, Ottawa.
- 119 Vefsnmo, S. and B.O. Johannessen. 1994. Experimental Oil Spill in the Barents Sea - Drift and Spread of Oil in Broken Ice. *Proceedings 17th Arctic and Marine Oil Spill Program Technical Seminar*. Environment Canada. Ottawa.
- 120 Ohtsuka, N., K. Ogiwara, S. Takahashi, K. Maida, Y. Watanabe, and H. Saeki. 2001. *Experimental Study on Spreading of Oil Under Ice Floes*. 16th International Port and Oceans Engineering Under Arctic Conditions, Ottawa, Canada.
- 121 Ivanov, B., A. Bezgreshnov, N. Kubyshkin, and A. Kursheva. 2005. *Spreading of Oil Products in Sea Ice and their Influence on the Radiation Properties of the Snow-Ice Cover*. 18th International Conference on Port and Ocean Engineering under Arctic Conditions. Clarkson University, Pottsdam, NY.
- 122 Dickins, D., Brandvik, P.J., Bradford, J., Faksness, L.-G., Liberty, L., and Daniloff, R. 2008. Svalbard 2006 Experimental Oil Spill Under Ice: Remote Sensing, Oil Weathering Under Arctic Conditions and Assessment of Oil Removal by In-Situ Burning. *Proceedings 2008 International Oil Spill Conference*, Savannah, Georgia.
- 123 Sørstrøm, S. E., P.-J. Brandvik, I. Buist, P. Daling, D. Dickins, L.-G. Faksness, S. Potter, J. F. Rasmussen, and I. Singsaas. 2010. *Joint Industry Program on Oil Spill Contingency for Arctic and Ice-covered Waters: Summary Report*. SINTEF Oil in Ice JIP, Trondheim, Norway.
- 124 Fingas, M.F. and Hollebone, B. P. 2002. *Behaviour of Oil in Freezing Environments: A Literature Review*. *Proceedings Arctic and Marine Oilspill Program Technical Seminar*. No. 25, Vol. 2, pp. 1191-1205. Environment Canada, Ottawa.

- 125 Brandvik, P. J. 2007. *Behaviour and Weathering of Oil Spills Under Arctic Conditions and Implications for Response*. International Oil & Ice Workshop, Anchorage, AK, Minerals Management Service.
- 126 SL Ross, D. Dickins and E. Planning. 2010. *Beaufort Sea Oil Spills State of Knowledge Review and Identification of Key Issues*. Calgary, Alberta, Canada, Environmental Studies Research Funds: 126.
- 127 Dickins, D. F. 2011. *Behavior of Oil Spills in Ice and Implications for Arctic Spill Response*. Arctic Technology Conference, Houston, TX, Offshore Technology Conference.
- 128 Dickins, D. F., I. A. Buist and W. M. Pistruzak. 1981. *Dome's Petroleum Study of Oil and Gas Under Sea Ice*. International Oil Spill Conference, Atlanta, GA.
- 129 Ibid.
- 130 McMinn, T.J. 1973. *Crude oil behaviour on Arctic winter ice*. U.S. Coast Guard Report No. 734108. Washington.
- 131 Vefsnmo, S. and B.O. Johannessen. 1994. Experimental Oil Spill in the Barents Sea - Drift and Spread of Oil in Broken Ice. *Proceedings 17th Arctic and Marine Oil Spill Program Technical Seminar*. Environment Canada. Ottawa.
- 132 Dickins, D. F. 2011. *Behavior of Oil Spills in Ice and Implications for Arctic Spill Response*. Arctic Technology Conference, Houston, TX, Offshore Technology Conference.
- 133 Swannell, R. P. J. and F. Daniel. 1999. *Effect of dispersants on oil biodegradation under simulated marine conditions*. 1999 International Oil Spill Conference, American Petroleum Institute, Washington, D.C.
- 134 MacNaughton, S. J., Swannell R., F. Daniel and L. Bristow. 2003. "Biodegradation of dispersed Forties crude and Alaskan North Slope oils in microcosms under simulated marine conditions." *Spill Science Technology Bulletin* 8: 179-186.
- 135 Prince, R. and J. Butler. 2014. "A protocol for assessing the effectiveness of oil spill dispersants in stimulating the biodegradation of oil." *Environmental Science and Pollution Research* 21(16): 9506-9510.
- 136 Lee, K., T. Nedwed, R.C. Prince and D. Palandro. 2013. Lab tests on the biodegradation of chemically dispersed oil should consider the rapid dilution that occurs at sea. *Marine Pollution Bulletin*, 73: 314-318.
- 137 Brown, H. M. and R. H. Goodman. 1996. The use of dispersants in broken ice. *Proceedings of the nineteenth Arctic and marine oilspill program (AMOP) technical seminar*, Canada, Environment Canada.
- 138 Owens, C. K. and R. S. Belore. 2004. Dispersant effectiveness testing in cold water and brash ice. *Proceedings of the 27 Arctic and Marine Oilspill Program (AMOP) Technical Seminar (V2)*, Canada, Environment Canada.
- 139 Sørstrøm, S. E., P.-J. Brandvik, I. Buist, P. Daling, D. Dickins, L.-G. Faksness, S. Potter, J. F. Rasmussen, and I. Singsaas. 2010. *Joint Industry Program on Oil Spill Contingency for Arctic and Ice-covered Waters: Summary Report*. SINTEF Oil in Ice JIP, Trondheim, Norway.
- 140 Daling, P. S., P. J. Brandvik, D. Mackay, and O. Johansen. 1990. "Characterization of crude oils for environmental purposes." *Oil and Chemical Pollution* 7(3): 199-224.
- 141 Brandvik, P. J., O. O. Knudsen, M. O. Moldestad, and P. S. Daling. 1995. "Laboratory testing of dispersants under Arctic conditions." *American Society for Testing and Materials, Special Technical Publication* (1252): 191-206.
- 142 Nedwed, T., J. L. M. Resby, and J. Guyomarch. 2006. *Dispersant Effectiveness after Extended Low-energy Soak Times*. 2006 International Conference for Spill Prevention, London, UK.
- 143 Owens, C. K. and R. S. Belore. 2004. Dispersant effectiveness testing in cold water and brash ice. *Proceedings of the 27 Arctic and Marine Oilspill Program (AMOP) Technical Seminar (V2)*, Canada, Environment Canada.
- 144 National Research Council. 2005. *Oil Spill Dispersants: Efficacy and Effects*, The National Academies Press, Washington, D.C.
- 145 Gardiner WW, Word JQ, Word JD, Perkins RA, McFarlin K, Hester BW, Word LS, and Ray CM. 2013. The acute toxicity of chemically and physically dispersed crude oil to key Arctic species under Arctic conditions during the open water season. *Environ Toxicol Chem* 32:2284-2300.
- 146 NOAA Office of Response and Restoration, "How Would Chemical Dispersants Work on an Arctic Oil Spill," July 9, 2012. <http://response.restoration.noaa.gov/about/media/how-would-chemical-dispersants-work-arctic-oil-spill.html>.
- 147 Sergy, G. A. and P. J. Blackall. 1987. *Design and Conclusions of the Baffin Island Oil Spill Project* VOL. 40, SUPP. 1 (1987) P. 1-Q ARCTIC.
- 148 Lewis, A., D. V. Aurand, and A. P. Institute. 1997. *Putting Dispersants to Work: Overcoming Obstacles: An Issue Paper Prepared for the 1997 International Oil Spill Conference*, American Petroleum Institute.
- 149 National Research Council. 2005. *Oil Spill Dispersants: Efficacy and Effects*, The National Academies Press, Washington, D.C.
- 150 Lewis, A., D. V. Aurand, and A. P. Institute. 1997. *Putting Dispersants to Work: Overcoming Obstacles: An Issue Paper Prepared for the 1997 International Oil Spill Conference*, American Petroleum Institute.
- 151 Spring, W., T. Nedwed, and R. Belore. 2006. "Icebreaker enhanced chemical dispersion of oil spills." *Proceedings of the 29 Arctic and Marine Oilspill Program (AMOP) Technical Seminar*, Canada, Environment Canada.
- 152 Nedwed, T., R. Belore, W. Spring, and D. Blanchet. 2007. Basinscale testing of ASD icebreaker enhanced chemical dispersion of oil spills. In *Proceedings of the AMOP Technical Seminar on Environmental Contamination and Response*, Environment Canada, Edmonton, AB.
- 153 Sørstrøm, S. E. 2009. *Full Scale Field Experiment 2009 Cruise Report*. SINTEF Materials and Chemistry, Trondheim, Norway.
- 154 Buist, I.A., S.G. Potter, B.K. Trudel, S.R. Shelnut, A.H. Walker, D.K. Scholz, P.J. Brandvik, J. Fritt-Rasmussen, A.A. Allen, and P. Smith. October 24, 2013. *In-Situ Burning in Ice-Affected Waters: State of Knowledge Report*, Final Report, 7.1.1 to the Arctic Response Technology Joint Industry Programme.
- 155 Allen A.A., D. Jager, N.J. Mabile, and D. Costanzo. 2011. The Use of Controlled Burning during the Gulf of Mexico Deepwater Horizon MC-252 Oil Spill Response. *International Oil Spill Conference Proceedings*, March 2011, Vol. 2011, No. 1, pp. abs194.
- 156 Allen, A.A. 1990. Contained Controlled Burning of Spilled Oil During the Exxon Valdez Oil Spill. *Proceedings of the Arctic and Marine Oilspill Program Technical Seminar*, No. 13, Environment Canada, Ottawa. pp. 305-313.
- 157 Mabile, N.J. 2010. *Fire Boom Performance Evaluation: Controlled Burning During the Deepwater Horizon Oil Spill. Operational Period, April 28th to July 18th 2010*. BP America.
- 158 Potter, S. and I. Buist. 2010. In-Situ Burning in Arctic and Ice-Covered Waters: Tests of Fire-Resistant Booms in Low Concentrations of Drift Ice. *Proceedings 33rd Arctic and Marine Oilspill Program Technical Seminar*, Halifax NS, pp. 743-754.
- 159 Buist, I.A., S.G. Potter, B.K. Trudel, S.R. Shelnut, A.H. Walker, D.K. Scholz, P.J. Brandvik, J. Fritt-Rasmussen, A.A. Allen, and P. Smith.

- October 24, 2013. *In-Situ Burning in Ice-Affected Waters: State of Knowledge Report*, Final Report 7.1.1 to the Arctic Response Technology Joint Industry Programme.
- 160 Preli, T., A.A. Allen, and D. Glenn. 2011. Development of high speed aerial ignition techniques for In-Situ burning. *Proceedings Arctic Technology Conference*.
- 161 Mullin, J. 2012. The Oil and Gas Industry's Commitment to Responsible Arctic Operations: An Innovative Arctic Oil Spill Response Technology – Joint Industry Program. OTC Paper 23800, *Proceedings Offshore Technology Conference*, Houston, TX.
- 162 Buist, I., Dickins, D., Majors, L., Linderman, K., Mullin, J., and Owens, C. 2003. Tests to Determine the Limits to in-situ Burning in Brash and Frazil Ice. *Proceedings Arctic and Marine Oilspill Program Technical Seminar*, No. 26, Vol. 2, pp. 629-648. Environment Canada, Ottawa.
- 163 Brandvik, P.J., L-G., Faksness, D.F. Dickins, and J. Bradford. 2006. *Weathering of Oil Spills Under Arctic Conditions: Field Experiments with Different Ice Conditions Followed by In-situ Burning*. Presented at the 2006 Third Annual NATO/CCMS Oil Spill Response Workshop, Oct 11-13, Dartmouth, NS, Canada.
- 164 Buist, I. and D. Dickins. 1987. Experimental spills of crude oil in pack ice. *Proceedings 1987 International Oil Spill Conference*. American Petroleum Institute. Washington.
- 165 Potter, S. and I. Buist. 2010. In-situ Burning in Arctic and Ice-covered Waters: Tests of fire-resistant booms in low concentrations of drift ice. *Proceedings 33rd Arctic and Marine Oilspill Program Technical Seminar*, Halifax NS, pp. 743-754.
- 166 Sørstrøm, S. E., P.-J. Brandvik, I. Buist, P. Daling, D. Dickins, L.-G. Faksness, S. Potter, J. F. Rasmussen, and I. Singsaas. 2010. *Joint Industry Program on Oil Spill Contingency for Arctic and Ice-covered Waters: Summary Report*. SINTEF Oil in Ice JIP, Trondheim, Norway.
- 167 World Wildlife Fund. 2010. *Drilling for Oil in the Arctic: Too Soon, Too Risky*. World Wildlife Fund, Washington, D.C.
- 168 Goodyear, J. and B. Beach. 2012. *Environmental Risks with Proposed Offshore Oil and Gas Development off Alaska's North Slope*, IP: 12-08-A. National Resources Defense Council.
- 169 Buist, I.A., S.L. Ross, B.K. Trudel, E. Taylor, T.G. Campbell, P.A. Westphal, M.R. Myers, G.S. Ronzio, A.A. Allen, and A.B. Nordvik. 1994. *The Science, Technology and Effects of Controlled Burning of Oil Spills at Sea*. MSRC Technical Report Series 94-013, Marine Spill Response Corporation, Washington, D.C., pp. 382.
- 170 Mabile, N. 2012. *The Coming of Age of Controlled In-Situ Burning: Transition from Alternative Technology to a Conventional Offshore Spill Response Option*. Presentation at Interspill 2012, London, UK.
- 171 Fingas, M.F., G. Halley, F. Ackerman, R. Nelson, M.C. Bissonnette, N. Laroche, Z. Wang, P. Lambert, K. Li, P. Jokuty, G. Sergy, W. Halley, J. Latour, R. Galarneau, B. Ryan, P.R. Campagna, R.D. Turpin, E.J. Tennyson, J. Mullin, L. Hannon, D. Aurand, and R. Hiltabrand. 1995. The Newfoundland offshore burn experiment. *Proceedings 1995 International Oil Spill Conference*, pp. 123-132. American Petroleum Institute. Washington, D.C.
- 172 McGrattan, K.B., W.D. Walton, A.D. Putorti, W.H. Twilley, J. McElroy, and D.D. Evans. 1995. Smoke plume trajectory from in-situ burning of crude oil in Alaska - Field experiments. *Proceedings Arctic and Marine Oilspill Program (AMOP) Technical Seminar*. No. 18, Vol. 2, pp. 901-913. Environment Canada, Ottawa, Canada.
- 173 Fingas, M.F., G. Halley, F. Ackerman, R. Nelson, M.C. Bissonnette, N. Laroche, Z. Wang, P. Lambert, K. Li, P. Jokuty, G. Sergy, W. Halley, J. Latour, R. Galarneau, B. Ryan, P.R. Campagna, R.D. Turpin, E.J. Tennyson, J. Mullin, L. Hannon, D. Aurand, and R. Hiltabrand. 1995. The Newfoundland offshore burn experiment. *Proceedings 1995 International Oil Spill Conference*, pp. 123-132. American Petroleum Institute. Washington, D.C.
- 174 Daykin, M., G. Sergy, D. Aurand, G. Shigenaka, Z. Wang, and A. Tang. 1994. Aquatic toxicity resulting from in-situ burning of oil-on-water. *Proceedings Arctic and Marine Oilspill Program (AMOP) Technical Seminar*. No. 17b:1165-1193. Environment Canada, Ottawa, Canada.
- 175 Blenkinsopp, S.A., G.A. Sergy, K.G. Doe, G.D. Wohlgeschaffen, K. Li, and M.F. Fingas. 1997. Evaluation of the toxicity of the weathered crude oil used at the Newfoundland offshore burn experiment (NOBE) and the resultant burn residue. *Proceedings Arctic and Marine Oilspill Program (AMOP) Technical Seminar*. No. 20a: 677-684. Environment Canada, Ottawa Canada.
- 176 Gulec, Ismail and Douglas A. Holdway. 1999. The Toxicity of Laboratory Burned Oil to the Amphipod *Allorchestes compressa* and the Snail *Polinices conicus*. *Spill Science & Technology Bulletin*, Vol. 5, No. 2, pp. 135-139.
- 177 Gagnon, Marthe Monique and Douglas Alan Holdway. 1999. Metabolic Enzyme Activities in Fish Gills as Biomarkers of Exposure to Petroleum Hydrocarbons, *Ecotoxicology and Environmental Safety* 44, 92-99.
- 178 Alaska Regional Response Team. 2008. In-Situ Burning Guidelines for Alaska: Revision 1. Appendix II, Annex F, *The Alaska Federal/State Preparedness Plan for Response to Oil and Hazardous Substance Discharges/Releases*.
- 179 American Society for Testing and Materials. 2009. ASTM F2152-Standard Guide for In-Situ Burning of Spilled Oil: Fire-Resistant Boom. *Annual Book of ASTM Standards*.
- 180 Buist, I., Dickins, D., Majors, L., Linderman, K., Mullin, J., and Owens, C. 2003. Tests to Determine the Limits to in-situ Burning in Brash and Frazil Ice. *Proceedings Arctic and Marine Oilspill Program Technical Seminar*. No. 26, Vol. 2, pp. 629-648. Environment Canada, Ottawa.
- 181 Michel, J., D. Scholz, S.R. Warren Jr., and A.H. Walker. 2005. *A Decision-Maker's Guide to In-Situ Burning*. Prepared under contract for the American Petroleum Institute, API Publication 4740.
- 182 Buist, I.A., S.G. Potter, B.K. Trudel, S.R. Shelnut, A.H. Walker, D.K. Scholz, P.J. Brandvik, J. Fritt-Rasmussen, A.A. Allen, and P. Smith. 24. October 2013. *In-Situ Burning in Ice-Affected Waters: State of Knowledge Report*, Final Report 7.1.1 to the Arctic Response Technology Joint Industry Programme.
- 183 Buist I.A., S. Potter, T. Nedwed and J. Mullin. 2011. Herding surfactants to contract and thicken oil spills in pack ice for In-Situ burning. S.L. Ross Environmental Research, ExxonMobil and U.S. Department of the Interior (BOEM), *Cold Regions Science and Technology* 67 (2011) 3–23.
- 184 Buist, I., Potter, S., and Sørstrøm, S.E. 2010. Barents Sea Field Test of Herder to Thicken Oil for In-Situ Burning in Drift Ice. *Proceedings 33rd AMOP Technical Seminar*, Halifax NS.
- 185 Buist I.A., S. Potter, T. Nedwed, and J. Mullin. 2011. Herding surfactants to contract and thicken oil spills in pack ice for In-Situ burning. S.L. Ross Environmental Research, ExxonMobil and U.S. Department of the Interior (BOEM), *Cold Regions Science and Technology* 67 (2011) 3–23.
- 186 Wilkman G. W., Uuskallio A., Ritari E., and Niini M. K. 2014. Technological Development in Oil Recovery in Ice Conditions. *Arctic Technology Conference Proceedings*.
- 187 Sørstrøm, S.E., P.-J. Brandvik, P.J., Buist, I., Daling, P., Dickins, D., Faksness, L.-G., Potter, S., Rasmussen, J.F., and Singsaas, I. 2010.

- Joint Industry Program on Oil Spill Contingency for Arctic and Ice-Covered Waters: Summary Report. Oil in Ice JIP Report No. 32, SINTEF, Trondheim, Norway.
- 188 SL Ross. 2010. *Evaluation of the Crucial Coated-Disk Skimmer in Arctic Conditions*. Report to Alaska Clean Seas.
- 189 Meyer P. 2014. Testing of Oil Recovery Skimmers in Ice at Ohmsett, the National Oil Spill Response Research & Renewable Energy Test Facility. *Proceedings of the International Oil Spill Conference*.
- 190 Wilkman G. W., Uuskallio A., Ritari E., and Niini M. K. 2014. Technological Development in Oil Recovery in Ice Conditions. *Arctic Technology Conference Proceedings*.
- 191 Potter S, Bronson M, Thompson E, and Majors L. 2007. Testing of Various Options for Improving the Pumping of Viscous Oils and Emulsions. *Proceedings of the AMOP Conference*.
- 192 Hvidbak, F . 2001. The Development and Test of Techniques for Emergency Transfer of Extreme Viscosity Oil (Refloated Bitumen). *Proceedings of AMOP Conference*.
- 193 Fleming Environmental and Hyde Marine. 2003. *Final Report - The Joint Viscous Oil Pumping System (JVOPS) Workshop*. A united effort by the U.S. Coast Guard, Canadian Coast Guard, U.S. Navy, and Response Community to promote and improve heavy viscous oil marine lightering response. Conducted at CENAC TOWING, INC. Houma, Louisiana, December 1 to 15, 2003. Prepared for: United States Coast Guard Ocean Engineering Division G-SEC-2 Office of Civil Engineering Contract No: HSCGG8-04-C-ECB004 20 June 20, 2003.
- 194 Potter S., Buist, I., Trudel K., Dickins D., Owens E. 2012. *Spill response in the Arctic offshore*, Prepared for the American Petroleum Institute and the Joint Industry Programme on Oil Spill Recovery in Ice.
- 195 Jensen, HV, Andersen JHS, and Gyltnes SL. 2012. Norwegian Oil Spill Response Technology Development. *Proceedings of INTERSPIL conference*.
- 196 Miller, S. 2014. Alaska's Approach to Determining Oil Recovery Rates and Efficiencies. *Proceedings of the International Oil Spill Conference*.
- 197 Meyer, P., Schmidt B., DeVitis D., and Delgado J.-E. 2012. High Capacity Advancing Oil Recovery System Performance Testing at Ohmsett for the Wendy Schmidt Oil Cleanup X CHALLENGE. *Proceedings of Interspill Conference*.
- 198 Hansen, K. 2000. *Boom vane field tests*. Report prepared for United States Coast Guard, Marine Safety and Environmental Protection Systems. Washington, D.C.
- 199 Dickins, D.F. and J.H.S. Andersen. 2009. *Remote Sensing Technology Review and Screening*. SINTEF Oil in Ice JIP, Report 22.
- 200 Fingas, M.F. and C.E. Brown. 2011. Oil spill remote sensing: A review. Pp. 111-158 in *Oil Spill Science and Technology*, edited by M. Fingas. Gulf Professional Publishing, Burlington, MA.
- 201 Bradford, J. H., D.F. Dickins, and P.J. Brandvik. 2010. Assessing the potential to detect oil spills in and under snow using airborne ground-penetrating radar. *Geophysics* 75(2): G1-G12.
- 202 Dickins, D.F., J.H.S. Andersen, P.J. Brandvik, I. Singsaas, T. Buvik, J. Bradford, and S. Sandven. 2010. *Remote Sensing for the Oil Ice Joint Industry Program 2007-2009*. Available, <http://www.dfdickins.com/pdf/DickinsJIPRemoteSensingLR.pdf>, retrieved 4 October 2013.
- 203 Dickins, D.F. and J.H.S. Andersen. 2009. *Remote Sensing Technology Review and Screening*. SINTEF Oil in Ice JIP, Report 22.
- 204 Ibid.
- 205 Hodgins, D.O., S.S. Salvador, S.E. Tinis, and D. Nazarenko. 1996. Radarsat SAR for oil spill response. *Spill Science and Technology Bulletin* 3(4): 241-246.
- 206 Lunel, T., L. Davies, S. Shimwell, V. Byfield, S. Boxall, and C. Gurney. 1997. Review of aerial/satellite remote sensing carried out at the *Sea Empress* incident. *Proceedings of the Third International Airborne Remote Sensing Conference*, Copenhagen, Denmark.
- 207 Babiker, M., K. Kloster, S. Sandven, and R. Hall. 2010. *The Utilisation of Satellite Images for the Oil in Ice Experiment in the Barents Sea*, May 2009. SINTEF Oil in Ice JIP, Report No. 29, 44 pp.
- 208 Leifer, I., W.J. Lehr, D. Simecek-Beatty, E. Bradley, R. Clark, P. Denison, H. Yongxiang, S. Matheson, C.E. Jones, B. Holg, M. Reif, D. A. Roberts, J. Sveikovskiy, G. Swayze, and JI. Wozencraft. 2012. State of the art satellite and airborne marine oil spill remote sensing: Application to the BP Deepwater Horizon oil spill. Elsevier. *Remote Sensing of Environment* 124: 185-209.
- 209 Dickins, D.F. 2000. *Detection and Tracking of Oil Under Ice*. Report prepared for the U.S. Department of Interior, Minerals Management Service, Herndon, VA.
- 210 Goodman, R. 2008. Oil under ice detection: What is the state of the art? Pp. 7-19 in *Oil Spill Response: A Global Perspective*, edited by W.F. Davidson, K. Lee, and A. Cogswell. Springer Netherlands, Houten.
- 211 Dickins, D.F. and J.H.S. Andersen. 2009. *Remote Sensing Technology Review and Screening*. Oil in Ice JIP, Report 22. SINTEF Materials and Chemistry, Marine Environmental Technology. Available, [http://www.sintef.no/project/JIP\\_Oil\\_In\\_Ice/Dokumenter/publications/JIP-rep-no-22-RSScreening-Final.pdf](http://www.sintef.no/project/JIP_Oil_In_Ice/Dokumenter/publications/JIP-rep-no-22-RSScreening-Final.pdf), retrieved 13 November 2013.
- 212 Fingas, M.F. and C.E. Brown. 2011. Oil spill remote sensing: A review. pp. 111-158 in *Oil Spill Science and Technology*, edited by M. Fingas. Gulf Professional Publishing, Burlington, MA.
- 213 American Petroleum Institute. 2012. *Spill Response in the Arctic Offshore*, Final report for the American Petroleum Institute and the Joint Industry Programme on Oil Spill Recovery in Ice, Washington D.C., p. 144.
- 214 Allen A.A., D. Jager, N.J. Mabile, and D. Costanzo. 2011. The Use of Controlled Burning during the Gulf of Mexico Deepwater Horizon MC-252 Oil Spill Response. *International Oil Spill Conference Proceedings*, March 2011, Vol. 2011, No. 1, pp. abs194.
- 215 Vaudrey, K., and D.F. Dickins. 1996. *Oil Spill Tracking at the Northstar Development During Break-up and Early Summer Using Satellite-Tracking Buoys*. Prepared for BP Exploration (Alaska) Inc., Anchorage, AK.
- 216 Dickins, D., P.J. Brandvik, J. Bradford, L.-G. Faskness, L. Liberty, and R. Daniloff. 2008. *Svalbard 2006 Experimental Oil Spill Under Ice: Remote Sensing, Oil Weathering Under Arctic Conditions and Assessment of Oil Removal by In-situ Burning*. International Oil Spill Conference, Savannah, GA, American Petroleum Institute.
- 217 Bradford, J. H., D.F. Dickins, and P.J. Brandvik. 2010. Assessing the potential to detect oil spills in and under snow using airborne ground-penetrating radar. *Geophysics* 75(2): G1-G12.
- 218 Nedwed, T., Srnka, L., and Thomann, H. 2008. Remote Detection of Oil Spilled under Ice and Snow using Nuclear Magnetic Resonance. *Proceedings of the 31st Arctic and Marine Oilspill Program (AMOP) Technical Seminar*. Calgary, AB Canada, Environment Canada: 693-702.
- 219 Dickins, D.F., J.H.S. Andersen, P.J. Brandvik, I. Singsaas, T. Buvik, J. Bradford, and S. Sandven. 2010. *Remote Sensing for the Oil Ice Joint Industry Program 2007-2009*. Available, <http://www.dfdickins.com/pdf/DickinsJIPRemoteSensingLR.pdf>, retrieved 4 October 2013.

- 220 Singsaas, I., Brandvik, P.J., Daling, P.S., Reed, M., and Lewis, A. 1994. Fate and Behaviour of Oils Spilled in the Presence of Ice – A comparison of the results from recent laboratory, meso-scale flume and field tests. *Proceedings Arctic and Marine Oilspill Program Technical Seminar*, No. 17, Vol. 1, pp. 355-370. Environment Canada, Ottawa.
- 221 Brandvik, P.J., and T. Buvik. 2009. *Using Dogs to Detect Oil Hidden in Snow and Ice--Results from Field Training on Svalbard*, April 2008. SINTEFJIP-rep-no-14-Oildog-snow-ice[1].pdf. Available, <http://www.sintef.no/Projectweb/JIP-Oil-In-Ice/Publications/>, retrieved 22 August 2011.
- 222 Dickins, D.F., and J.H.S. Andersen. 2009. *Remote Sensing Technology Review and Screening*. Oil in Ice—JIP, Report 22. SINTEF Materials and Chemistry, Marine Environmental Technology. Available, [http://www.sintef.no/project/JIP\\_Oil\\_In\\_Ice/Dokumenter/publications/JIP-rep-no-22-RSScreening-Final.pdf](http://www.sintef.no/project/JIP_Oil_In_Ice/Dokumenter/publications/JIP-rep-no-22-RSScreening-Final.pdf), retrieved 13 November 2013.
- 223 Wadhams, P., J.P. Wilkinson, and S.D. McPhail. 2006. A new view of the underside of Arctic sea ice. *Geophysical Research Letters* 33(4): L04501.
- 224 Wilkinson, J., T. Maksym, C. Bassett, A. Lavery, H. Singh, D. Chayes, and P. Jochmann. 2014. *Oil Detection Under Sea Ice. Experiments Performed in the Experimental Basins at HSVA*. Report to the European Commission from HSVA Ice Tank. Hamburg, Germany.
- 225 Kurt Hansen, USCG, personal communication, February 3, 2014.
- 226 International Petroleum Industry Environmental Conservation Association (IPIECA). 2001. *Dispersants and their role in oil spill response*, 2nd Edition. IPIECA Report Series Volume Five. London, UK. pp. 36.
- 227 De Hoop L, Schipper AM, Leuven RSEW, Huijbregts MAJ, Olsen GH, Smit MGD, and AJ Hendriks. 2011. Sensitivity of polar and temperate marine organisms to oil components. *Environmental Science & Technology* 45(20):9017-9023.
- 228 Olsen, GH, MGD Smit, JL Carroll, I Jaeger, T Smith, and L Camus. 2011. Arctic versus temperate comparison of risk assessment metrics for 2-methyl-naphthalene. *Mar Environ Res* (2011): 1-9.
- 229 Gardiner WW, Word JQ, Word JD, Perkins RA, McFarlin K, Hester BW, Word LS, and Ray CM. 2013. The acute toxicity of chemically and physically dispersed crude oil to key Arctic species under Arctic conditions during the open water season. *Environ Toxicol Chem* 32:2284-2300.
- 230 McFarlin KM, Prince RC, Perkins RA, and Leigh MB. 2014. *Biodegradation of Dispersed Oil in Arctic Seawater at -1°C*. PLOS ONE, Volume 9, Issue 1.
- 231 Efroymson, R. A., J. P. Nicolette, and G. W. Suter II. 2003. *A framework for net environmental benefit analysis for remediation or restoration of petroleum-contaminated sites*. ORNL/TM-2003/17. Oak Ridge National Laboratory, Oak Ridge, Tennessee.
- 232 Shigenaka, G. 2014. *Twenty-Five Years After the Exxon Valdez Oil Spill: NOAA's Scientific Support, Monitoring, and Research*. Seattle: NOAA Office of Response and Restoration. 78 pp.
- 233 Trudel, B.K., R.C. Belore, B.J. Jessiman, and S.L. Ross. 1989. A Micro-computer-Based Spill Impact Assessment System for Untreated and Chemically Dispersed Oil Spills in the U.S. Gulf of Mexico. *Proc. 1989 Oil Spill Conference*, San Antonio, Texas, Feb. 1989, pp. 533-537.
- 234 Baker JM. 1995. Net Environmental Benefit Analysis for Oil Spill Response. *International Oil Spill Conference Proceedings*, February 1995, Vol. 1995, No. 1, pp. 611-614.
- 235 Kraly J, Pond RG, Walker AH, Caplis J, Aurand DV, Coelho GM, Martin B, and Sowby M. 2001. Ecological Risk Assessment Principles Applied to Oil Spill Response Planning. *International Oil Spill Conference Proceedings*, March 2001, Vol. 2001, No. 1, pp. 177-184.
- 236 Chapman PM, and Riddle MJ. 2003 Missing and needed: polar marine ecotoxicology. *Mar Pollut Bull.* 46(8):927-8.
- 237 Chapman PM and MJ Riddle 2005. Polar marine toxicology—future research needs *Mar Pollut Bull* 50:905-908.
- 238 Olsen, G. H., Sva, E., Carroll, J., Camus, L., De Coen W, Smolders R, Øveraaas H, and Hylland K. 2007. Alterations in energy budget of Arctic benthic species exposed to oil related compounds *Aquat Toxicol* 83:85-92.
- 239 National Research Council. 2014. *Responding to Oil Spills in the Arctic*. National Academies Press, Washington, D.C.
- 240 Cormack D, and Nichols J. 1977. The concentrations of oil in sea water resulting from natural and chemically induced dispersion of oil slicks. *Proceedings 1977 Oil Spill Conference*, American Petroleum Institute, New Orleans, LA, March 8–10, 1977, pp. 381–385.
- 241 McAuliffe C, Johnson J, Greene S, Canevari G, and Searl D. 1980. Dispersion and weathering of chemically treated crude oils on the ocean. *Environ Sci Technol* 14:1509–1518.
- 242 McAuliffe C, Steelman R, Leek W, Fitzgerald D, and Ray J. 1981. 1979 Southern California dispersant treated research oil spills. *Proceedings 1981 Oil Spill Conference*, American Petroleum Institute, Atlanta, GA, March 2–5, 1981, pp. 269–282.
- 243 Lichtentaler R, and Daling PS. 1983. Dispersion of chemically treated crude oil in Norwegian offshore waters. *Proceedings 1983 Oil Spill Conference*, American Petroleum Institute, San Antonio, TX, February 28–March 3, 1983, pp. 7–14.
- 244 Lunel T. 1994. *Dispersion of a large experimental slick by aerial application of dispersant*. Arctic and marine oil spill program technical seminar, pp. 951–951.
- 245 Lewis A, Daling P, Stoem-Kristiansen T, and Brandvik P. 1995. *The behaviour of Sture blend crude oil spilled at sea and treated with dispersant*. Arctic and marine oil spill program technical seminar, pp. 453–470.
- 246 Brandvik PJ, Lewis A, Strom-Kristiansen T, Hokstad, JN, and Daling PS. 1996. *NOFO 1996 Oil on water exercise: Operational testing of the new "Response 3000" helicopter bucket*. Report No. 41.5164.00/01/96. SINTEF Applied Chemistry, Trondheim, Norway.
- 247 Strom-Kristiansen T, Hokstad J, Lewis A, and Brandvik P. 1997. *NOFO 1996—Oil on water exercise: Analysis of sample material*. STF66 A97050. SINTEF, Trondheim, Norway.
- 248 Bejarano, A., Levine E, and Mearns AJ. 2013. Effectiveness and potential ecological effects of offshore surface dispersant use during the Deepwater Horizon oil spill: a retrospective analysis of monitoring data. *Environmental Monitoring Assess* (2013) 185:10281–10295.
- 249 Cormack D, Nichols J. 1977. The concentrations of oil in sea water resulting from natural and chemically induced dispersion of oil slicks. *Proceedings 1977 Oil Spill Conference*, American Petroleum Institute, New Orleans, LA, March 8–10, 1977, pp. 381–385.
- 250 McAuliffe C, Johnson J, Greene S, Canevari G, and Searl D. 1980. Dispersion and weathering of chemically treated crude oils on the ocean. *Environ Sci Technol* 14:1509–1518.
- 251 McAuliffe C, Steelman R, Leek W, Fitzgerald D, and Ray J. 1981. 1979 Southern California dispersant treated research oil spills. *Proceedings 1981 Oil Spill Conference*, American Petroleum Institute, Atlanta, GA, March 2–5, 1981, pp. 269–282.
- 252 Lunel T. 1994. *Dispersion of a large experimental slick by aerial application of dispersant*. Arctic and marine oil spill program technical seminar, pp. 951–951.

- 253 Strom-Kristiansen T, Hokstad J, Lewis A, and Brandvik P. 1997. *NOFO 1996—Oil on water exercise: Analysis of sample material*. STF66 A97050. SINTEF, Trondheim, Norway.
- 254 Daling PS and Indrebo G. 1996. *Recent Improvements in optimizing use of dispersants as a cost-effective oil spill countermeasure technique*. International Conference on Health and Safety and Environment, New Orleans.
- 255 Trudel, K., R. Belore, M. VanHaverbeke, and J. Mullin. 2009. Updating the U.S. SMART dispersant efficacy monitoring protocol. *Proceedings Arctic and Marine Oilspill Program (AMOP) Technical Seminar*. Environment Canada, Ottawa, Canada, pp. 397-410.
- 256 Cormack D, Nichols J. 1977. The concentrations of oil in sea water resulting from natural and chemically induced dispersion of oil slicks. *Proceedings 1977 Oil Spill Conference*, American Petroleum Institute, New Orleans, LA, March 8-10, 1977, pp. 381-385.
- 257 McAuliffe C, Johnson J, Greene S, Canevari G, and Searl D. 1980. Dispersion and weathering of chemically treated crude oils on the ocean. *Environ Sci Technol* 14:1509-1518.
- 258 International Petroleum Industry Environmental Conservation Association (IPIECA). 2001. *Dispersants and their role in oil spill response*, 2nd Edition. IPIECA Report Series Volume Five. London, UK, pp. 36.
- 259 French McCay, D.P. and J.R. Payne. 2001. Model of oil fate and water concentrations with and without application of dispersants. *Proceedings Arctic and Marine Oilspill Program (AMOP) Technical Seminar*. Environment Canada, Ottawa, Canada, pp. 611-645.
- 260 French McCay, D.P., J.J. Rowe, W. Nordhausen, and J.R. Payne. 2006. Modeling potential impacts of effective dispersant use on aquatic biota. *Proceedings Arctic and Marine Oilspill Program (AMOP) Technical Seminar*. Environment Canada, Ottawa, Canada, pp. 855-878.
- 261 Potter S., Buist, I., Trudel K., Dickens D., and Owens E. 2012. *Spill response in The Arctic offshore*, Prepared for the American Petroleum Institute and the Joint Industry Programme on Oil Spill Recovery in Ice.
- 262 National Research Council. 1989. *Using Oil Spill Dispersants on the Sea*. National Academies Press, Washington, D.C.
- 263 Gilfillan E, Hanson S, Vallas D, Gerber R, Page D, Foster J, Hotham and J, Pratt S. 1983. Effect of spills of dispersed and non-dispersed oil on intertidal infaunal community structure. *Proceedings 1983 International Oil Spill Conference*, American Petroleum Institute, San Antonio, TX, February 28–March 3, 1983, pp. 457–463.
- 264 National Research Council. 1989. *Using Oil Spill Dispersants on the Sea*. National Academies Press, Washington, D.C.
- 265 Brandvik PJ, Lewis A, Strom-Kristiansen T, and Hokstad, JN, Daling PS. 1996. *NOFO 1996 Oil on water exercise: Operational testing of the new “Response 3000” helicopter bucket*. Report No. 41.5164.00/01/96. SINTEF Applied Chemistry, Trondheim, Norway.
- 266 Lewis A, and Aurand D. 1997. Putting dispersants to work: Overcoming obstacles. *Proceedings 1997 Oil Spill Conference*, American Petroleum Institute, Fort Lauderdale, FL, April 7–10, 1997, pp. 157–164.
- 267 Bragin G, Febbo E, Clark J, Coelho G, and Aurand D. 1999. Coastal Oilspill Simulation System comparison of oil and chemically dispersed oil released in near-shore environments: Biological effects. *Proceedings Twenty-Second Arctic and Marine Oil Spill Program Technical Seminar*, Environment Canada, Calgary, Alberta, Canada, pp. 671–684.
- 268 Coelho GM, Aurand DV, Petch GS, and Jones DM. 2002. *Toxicity bioassays on dispersed oil in the North Sea: June 1996 Field Trials*. Publication DR 342, American Petroleum Institute, Washington, D.C.
- 269 Baca B, Ward GA, Lane CH, and Schuler PA. 2005. Net environmental benefit analysis of dispersed oil on nearshore tropical ecosystems derived from the 20 year “TROPICS” field study. *Proceedings 2005 International Oil Spill Conference*, American Petroleum Institute Miami Beach, FL, pp. 453-456.
- 270 National Research Council. 1989. *Using Oil Spill Dispersants on the Sea*. National Academies Press, Washington, D.C.
- 271 National Research Council. 2005. *Oil Spill Dispersants: Efficacy and Effects*. National Academies Press, Washington, D.C.
- 272 Henry C. 2005. Review of dispersant use in US Gulf of Mexico waters since the Oil Pollution Act of 1990. *Proceedings 2005 International Oil Spill Conference*, American Petroleum Institute, Miami Beach, FL, pp. 439-442.
- 273 Lubchenco J, McNutt MK, Dreyfus G, Murawski SA, Kennedy DM, Anastas PT, Chu S, and Hunter T. 2012. Science in support of the Deepwater Horizon response. *Proc Natl Acad Sci USA* 109:20212–20221.
- 274 Bejarano A.C., J. Clark, and G. Coelho. 2014. Issues and challenges with oil toxicity data and implications for their use in decision making: A quantitative review. *Environmental Toxicology and Chemistry* 33:732-742.
- 275 National Research Council. 1989. *Using Oil Spill Dispersants on the Sea*. National Academies Press, Washington, D.C.
- 276 National Research Council. 2003. *Oil in the Sea III: Inputs, Fates, and Effects*. National Academies Press, Washington, D.C.
- 277 National Research Council. 2005. *Oil Spill Dispersants: Efficacy and Effects*. National Academies Press, Washington, D.C.
- 278 Markarian RK, Nicolette JP, Barber TR, and Giese LH. 1995. *A Critical Review of Toxicity Values and an Evaluation of the Persistence of Petroleum Products for Use in Natural Resource Damage Assessments*. American Petroleum Institute, Washington, D.C.
- 279 Di Toro DM, McGrath JA, Hansen DJ. 2000. Technical basis for narcotic chemicals and polycyclic aromatic hydrocarbon criteria. I. Water and tissue. *Environ Toxicol Chem* 19:1951–1970.
- 280 Di Toro DM, McGrath JA, and Stubblefield WA. 2007. Predicting the toxicity of neat and weathered crude oil: Toxic potential and the toxicity of saturated mixtures. *Environ Toxicol Chem* 26:24–36.
- 281 French-McCay DP. 2002. Development and application of an oil toxicity and exposure model, OilToxEx. *Environ Toxicol Chem* 21:2080–2094.
- 282 Olsen GH, Klok C, Hendriks AJ, Geraudie P, De Hoop L, De Laender F, Farmen E, Grøsvik BE, Hansen BH, Hjorth M, Jansen CR, Nordtug T, Ravagnan E, Viaene K, Carroll J. 2013. Toxicity data for modeling impacts of oil components in an Arctic ecosystem. *Mar Environ Res*. 90:9-17.
- 283 Bejarano A.C., J. Clark, G. Coelho. 2014. Issues and challenges with oil toxicity data and implications for their use in decision making: A quantitative review. *Environmental Toxicology and Chemistry* 33:732-742.
- 284 Christiansen JS, Dalmo RA, and Ingebrigtsen K. 1996. Xenobiotic excretion in fish with aglomerular kidneys. *Mar Ecol Prog Ser* 136:303-304.
- 285 Ingebrigtsen K, Christiansen JS, Lindhe Ö, and Brandt I. 2000. Disposition and cellular binding of 3H-benzo(a)pyrene at subzero temperatures: studies in an aglomerular Arctic teleost fish – the polar cod (*Boreogadus saida*). *Polar Biology* 23:503-509.
- 286 Perkins RA, S Rhoton, and C Behr-Andres. 2005. Comparative marine toxicity testing: A cold-water species and standard warm-water test

- species exposed to crude oil and dispersant. *Cold Regions Science and Technology* 42(3):226-236.
- 287 Jensen MH, Nielsen TG, Dahllöf I. 2008. Effects of pyrene on grazing and reproduction of *Calanus finmarchicus* and *Calanus glacialis* from Disko Bay. *West Greenland Aquat Toxicol* 87:99–107.
- 288 Baussant T, Bechmann RK, Taban IC, Larsen BK, Tandberg AH, Bjørnstad A, Torggrimsen S, Nævdal A, Øysæd KB, Jonsson G, Sanni S. 2009. Enzymatic and cellular responses in relation to body burden of PAHs in bivalve molluscs: A case study with chronic levels of North Sea and Barents Sea dispersed oil. *Marine Pollution Bulletin*, 58(12):1796-1807.
- 289 Skadsheim A, Sanni S, Pinturier L, Moltu UE, Buffagni M, and Bracco L. 2009. Assessing and monitoring local and long-range-transported hydrocarbons as potential stressors to fish stocks. *Deep-Sea Res II* 56:2037–2043.
- 290 Jensen LK and J Carroll. 2010. Experimental Studies of Reproduction and Feeding for Two Arctic-Dwelling *Calanus* Species Exposed to Crude Oil. *Aquat Biol* 10:261-271.
- 291 Hansen BH, Altin D, Rørvik SV, Øverjordet IB, Olsen AJ, Nordtug T. 2011. Comparative study on acute effects of water accommodated fractions of an artificially weathered crude oil on *Calanus finmarchicus* and *Calanus glacialis* (Crustacea: Copepoda). *Sci Total Environ*, 409(4):704-709.
- 292 Hjorth M, Nielsen TG. 2011. Oil exposure in a warmer Arctic: potential impacts on key zooplankton species. *Mar Biol* 158:1339–1347.
- 293 Hansen BH, Altin D, Olsen AJ, Nordtug T. 2012. Acute toxicity of naturally and chemically dispersed oil on the filter-feeding copepod *Calanus finmarchicus*. *Ecotoxicol Environ Saf* 86:38-46.
- 294 Gardiner WW, Word JQ, Word JD, Perkins RA, McFarlin K, Hester BW, Word LS, and Ray CM. 2013. The acute toxicity of chemically and physically dispersed crude oil to key Arctic species under Arctic conditions during the open water season. *Environ Toxicol Chem* 32:2284-2300.
- 295 McFarlin, K. M., R.A. Perkins, W.W. Gardner, J.D. Word, and J.Q. Word. 2011. Toxicity of physically and chemically dispersed oil to selected Arctic Species. *Proceedings of the 2011 International Oil Spill Conference*. Portland, OR, #2011-149.
- 296 De Hoop L, Schipper AM, Leuven RSEW, Huijbregts MAJ, Olsen GH, Smit MGD, and AJ Hendriks. 2011. Sensitivity of polar and temperate marine organisms to oil components. *Environmental Science & Technology* 45(20):9017-9023.
- 297 Olsen, GH, MGD Smit, JL Carroll, I Jaeger, T Smith, and L Camus. 2011. Arctic versus temperate comparison of risk assessment metrics for 2-methyl-naphthalene. *Mar Environ Res* (2011): 1-9.
- 298 Gardiner WW, Word JQ, Word JD, Perkins RA, McFarlin K, Hester BW, Word LS, and Ray CM. 2013. The acute toxicity of chemically and physically dispersed crude oil to key Arctic species under Arctic conditions during the open water season. *Environ Toxicol Chem* 32:2284-2300.
- 299 De Hoop L, Schipper AM, Leuven RSEW, Huijbregts MAJ, Olsen GH, Smit MGD, and AJ Hendriks. 2011. Sensitivity of polar and temperate marine organisms to oil components. *Environmental Science & Technology* 45(20):9017-9023.
- 300 Olsen, GH, MGD Smit, JL Carroll, I Jaeger, T Smith, and L Camus. 2011. Arctic versus temperate comparison of risk assessment metrics for 2-methyl-naphthalene. *Mar Environ Res* (2011): 1-9.
- 301 Gardiner WW, Word JQ, Word JD, Perkins RA, McFarlin K, Hester BW, Word LS, and Ray CM. 2013. The acute toxicity of chemically and physically dispersed crude oil to key Arctic species under Arctic conditions during the open water season. *Environ Toxicol Chem* 32:2284-2300.
- 302 NFR. 2012. *Long-term effects of discharges to sea from petroleum-related activities - The results of ten years' research*. Norske Forskningsrådet. Technical report.
- 303 Zinger L, Amaral-Zettler LA, Fuhrman JA, Horner-Devine C, Huse S, Welch D, Martiny J, Sogin M, Boetius A, and Ramette A. 2011. *Global patterns of bacterial beta-diversity in seafloor and seawater ecosystems* PLoS ONE 6: e24570.
- 304 Sul WJ, Oliver TA, Ducklow HW, Amaral-Zettler LA, and Sogin ML. 2013. Marine bacteria exhibit a bipolar distribution. *Proc Natl Acad Sci USA*.
- 305 Deppe U, Richnow HH, Michaelis W, Antranikian G. 2005. Degradation of crude oil by an Arctic microbial consortium. *Extremophiles* 9: 461-470.
- 306 Hazen, T.C., E.A. Dubinsky, T.Z. DeSantis, G.L. Andersen, Y.M. Piceno, N. Singh, J.K. Jansson, A. Probst, S.E. Borglin, J.L. Fortney, W.T. Stringfellow, M. Bill, M.S. Conrad, L.M. Tom, K.L. Chavarria, T.R. Alusi, R. Lamendella, D.C. Joyner, C. Spier, J. Baelum, M. Auer, M.L. Zemla, R. Chakraborty, E.L. Sonnenthal, P. D. Haeseleer, H-Y.N. Holman, S. Osman, Z. Lu, J.D. Van Nostrand, Y. Deng, J. Zhou, and O.U. Mason. 2010. Deep-sea oil plume enriches indigenous oil-degrading bacteria. *Science*, August 24, 2010, doi: 10.1126/science.1195979.
- 307 Lessard, R. and G. Demarco. 2000. The significance of oil spill dispersants. *Spill Science & Technology Bulletin*, Volume 6, Issue 1, February 2000, pp. 59-68.
- 308 MacNaughton, S. J., Swannell R., F. Daniel and L. Bristow. 2003. Biodegradation of dispersed Forties crude and Alaskan North Slope oils in microcosms under simulated marine conditions. *Spill Science Technology Bulletin* 8: 179-186.
- 309 Swannell, R. P. J. and F. Daniel. 1999. *Effect of dispersants on oil biodegradation under simulated marine conditions*. 1999 International Oil Spill Conference, American Petroleum Institute, Washington, D.C.
- 310 Hazen, T.C., E.A. Dubinsky, T.Z. DeSantis, G.L. Andersen, Y.M. Piceno, N. Singh, J.K. Jansson, A. Probst, S.E. Borglin, J.L. Fortney, W.T. Stringfellow, M. Bill, M.S. Conrad, L.M. Tom, K.L. Chavarria, T.R. Alusi, R. Lamendella, D.C. Joyner, C. Spier, J. Baelum, M. Auer, M.L. Zemla, R. Chakraborty, E.L. Sonnenthal, P. D. Haeseleer, H-Y.N. Holman, S. Osman, Z. Lu, J.D. Van Nostrand, Y. Deng, J. Zhou, and O.U. Mason. 2010. Deep-sea oil plume enriches indigenous oil-degrading bacteria. *Science*, August 24, 2010, doi: 10.1126/science.1195979.
- 311 Prince RC. and JD. Butler. 2013. A protocol for assessing the effectiveness of oil spill dispersants in stimulating the biodegradation of oil. *Environ Sci Pollut Res Int*. August 2013.
- 312 Lee, K., T. Nedwed, R.C. Prince, and D. Palandro. 2013. Lab tests on the biodegradation of chemically dispersed oil should consider the rapid dilution that occurs at sea. *Marine Pollution Bulletin*, 73: 314–318.
- 313 Lee, K., T. Nedwed, R.C. Prince, and D. Palandro. 2013. Lab tests on the biodegradation of chemically dispersed oil should consider the rapid dilution that occurs at sea. *Marine Pollution Bulletin*, 73: 314–318.
- 314 Prince RC. and JD. Butler. 2013. A protocol for assessing the effectiveness of oil spill dispersants in stimulating the biodegradation of oil. *Environ Sci Pollut Res Int*. Aug 2013.
- 315 Prince, R. and J. Butler. 2014. A protocol for assessing the effectiveness of oil spill dispersants in stimulating the biodegradation of oil. *Environmental Science and Pollution Research* 21(16): 9506-9510.

- 316 Venosa, A.D. and E.L. Holder. 2007. Biodegradability of dispersed crude oil at two different temperatures. *Marine Pollution Bull.* 54:545-553.
- 317 McFarlin, K. M., R.A. Perkins, W.W. Gardner, J.D. Word, and J.Q. Word. 2011. Toxicity of physically and chemically dispersed oil to selected Arctic Species. *Proceedings of the 2011 International Oil Spill Conference*. Portland, OR, #2011-149.
- 318 Brakstad OG, and Bonaunet K. 2006. Biodegradation of petroleum hydrocarbons in seawater at low temperatures (0-5 degrees C) and bacterial communities associated with degradation. *Biodegradation* 17: 71-82.
- 319 Margesin R, Gander S, Zacke G, Gounot AM, and Schinner F. 2003. Hydrocarbon degradation and enzyme activities of cold-adapted bacteria and yeasts. *Extremophiles* 7: 451-458.
- 320 Michaud L, Lo Giudice A, Saitta M, De Domenico M, and Bruni V. 2004. The biodegradation efficiency on diesel oil by two psychrotrophic AntArctic marine bacteria during a two-month-long experiment. *Mar Pollut Bull* 49: 405-409.
- 321 Hazen, T.C., E.A. Dubinsky, T.Z. DeSantis, G.L. Andersen, Y.M. Piceno, N. Singh, J.K. Jansson, A. Probst, S.E. Borglin, J.L. Fortney, W.T. Stringfellow, M. Bill, M.S. Conrad, L.M. Tom, K.L. Chavarria, T.R. Alusi, R. Lamendella, D.C. Joyner, C. Spier, J. Baelum, M. Auer, M.L. Zemla, R. Chakraborty, E.L. Sonnenthal, P. D'haeseleer, H.-Y.N. Holman, S. Osman, Z. Lu, J.D. Van Nostrand, Y. Deng, J. Zhou, and O.U. Mason. 2010. Deep-sea oil plume enriches indigenous oil-degrading bacteria. *Science*, August 24, 2010, doi: 10.1126/science.1195979.
- 322 Brakstad, O.G., Daling, P.S., Faksness, L-G, Almas, I.K., Vang, S-H, Syslak, L., and Leirvik, F. 2014. Depletion and biodegradation of hydrocarbons in dispersions and emulsions of the Macondo 252 oil generated in an oil-on-seawater mesocosm flume basin. *Marine Pollution Bulletin* 84 (2014) 125-134.
- 323 Potter S., Buist, I., Trudel K., Dickins D., and Owens E. 2012. *Spill response in the Arctic offshore*, Prepared for the American Petroleum Institute and the Joint Industry Programme on Oil Spill Recovery in Ice.
- 324 Fingas, M.F., F. Ackerman, K. Li, P.G. Lambert, Z. Wang, M.C. Bissonnette, P.R. Campagna, P. Boileau, N.D. Laroche, P. Jokuty, R.D. Nelson, R.D. Turpin, M.J. Trespalacios, G. Halley, J.M.R. Bélanger, J.R.J. Paré, N. Vanderkooy, E.J. Tennyson, D.V. Aurand, and R.R. Hiltabrand. 1994. The Newfoundland offshore burn experiment (NOBE) - Preliminary results of emissions measurement. *Proceedings Arctic and Marine Oilspill Program (AMOP) Technical Seminar*. No. 17b:1099-1164. Environment Canada, Ottawa, Canada.
- 325 McGrattan, K.B., H.R. Baum, and R.G. Rehm. 1994. Smoke plume trajectory from in-situ burning of crude oil in Alaska. *Proceedings Arctic and Marine Oilspill Program (AMOP) Technical Seminar*. No. 17, Vol. 1, pp. 725-733. Environment Canada, Ottawa, Canada.
- 326 McGrattan, K.B., W.D. Walton, A.D. Putorti, W.H. Twilley, J. McElroy, and D.D. Evans. 1995. Smoke plume trajectory from in-situ burning of crude oil in Alaska - Field experiments. *Proceedings Arctic and Marine Oilspill Program (AMOP) Technical Seminar*. No. 18, Vol. 2, pp. 901-913. Environment Canada, Ottawa, Canada.
- 327 Daykin, M., G. Sergy, D. Aurand, G. Shigenaka, Z. Wang, and A. Tang. 1994. Aquatic toxicity resulting from in-situ burning of oil-on-water. *Proceedings Arctic and Marine Oilspill Program (AMOP) Technical Seminar*. No. 17b:1165-1193. Environment Canada, Ottawa, Canada.
- 328 Blenkinsopp, S.A., G.A. Sergy, K.G. Doe, G.D. Wohlgeschaffen, K. Li, and M.F. Fingas. 1997. Evaluation of the toxicity of the weathered crude oil used at the Newfoundland offshore burn experiment (NOBE) and the resultant burn residue. *Proceedings Arctic and Marine Oilspill Program (AMOP) Technical Seminar*. No. 20a: 677-684. Environment Canada, Ottawa, Canada.
- 329 Martinelli, M., A. Luise, E. Tromellini, T. Sauer, J. Neff, and G. Douglas. 1995. The M/C Haven oil spill: Environmental assessment of exposure pathways and resource injury. *Proceedings 1995 International Oil Spill Conference*. American Petroleum Institute. Washington, D.C.
- 330 Moller, T.H. 1992. Recent experience of oil sinking. *Proceedings Arctic and Marine Oilspill Program (AMOP) Technical Seminar*. No. 15:11-14. Environment Canada, Ottawa, Canada.
- 331 Potter S., Buist, I., Trudel K., Dickins D., and Owens E. 2012. *Spill response in the Arctic offshore*. Prepared for the American Petroleum Institute and the Joint Industry Programme on Oil Spill Recovery in Ice.
- 332 OGP Fact Sheet. 2011. Research in Support of the Arctic Oil Spill Response Technology Joint Industry Programme.
- 333 Dickins, D.F. and I.A. Buist. 1981. *Oil and Gas Under Sea Ice Study: Vols. 1&2*. Prepared by Dome Petroleum Ltd. for COOSRA, Report CV-1, Calgary, AB, Canada (also published in *Proceedings 1981 Oil Spill Conference*, Atlanta, GA).
- 334 Fingas, M.F. and Hollebone, B. P. 2002. Behaviour of Oil in Freezing Environments: A Literature Review. *Proceedings Arctic and Marine Oilspill Program Technical Seminar*. No. 25, Vol. 2, pp. 1191-1205. Environment Canada, Ottawa.
- 335 Brandvik, P. J. 2007. *Behaviour and Weathering of Oil Spills Under Arctic Conditions and Implications for Response*. International Oil & Ice Workshop, Anchorage, AK, Minerals Management Service.
- 336 SL Ross, D. Dickins and E. Planning. 2010. *Beaufort Sea Oil Spills State of Knowledge Review and Identification of Key Issues*. Calgary, Alberta, Canada, Environmental Studies Research Funds: 126.
- 337 Dickins, D. F. 2011. *Behavior of Oil Spills in Ice and Implications for Arctic Spill Response*. Arctic Technology Conference, Houston, TX, Offshore Technology Conference.
- 338 Nelson, William G. and A. A. Allen. 1982. The physical interaction and cleanup of crude oil with slush and solid first year sea ice. *Proc. Fifth Arctic and Marine Oil Spill program Technical Seminar*. Environment Canada. Ottawa.
- 339 Buist, I. and D. Dickins. 1987. Experimental spills of crude oil in pack ice. *Proceedings 1987 International Oil Spill Conference*. American Petroleum Institute. Washington.
- 340 Lee, K., Z. Li, B. Robinson, P.E. Kepkay, M. Blouin, and B. Doyon. 2011. *Field trials of in-situ oil spill countermeasures in ice-infested waters*. Presented at the 2011 International Oil Spill Conference, Portland, Oregon. American Petroleum Institute, Washington, D.C., 16 pp.
- 341 Dickins, D., P.J. Brandvik, J. Bradford, L.-G. Faskness, L. Liberty, and R. Daniloff. 2008. *Svalbard 2006 Experimental Oil Spill Under Ice: Remote Sensing, Oil Weathering Under Arctic Conditions and Assessment of Oil Removal by In-situ Burning*. International Oil Spill Conference, American Petroleum Institute. Savannah, GA.
- 342 Sørstrøm, S. E., P.-J. Brandvik, I. Buist, P. Daling, D. Dickins, L.-G. Faksness, S. Potter, J. F. Rasmussen, and I. Singaas. 2010. *Joint Industry Program on Oil Spill Contingency for Arctic and Ice-covered Waters: Summary Report*. SINTEF Oil in Ice JIP, Trondheim, Norway.
- 343 SL Ross, D. Dickins, and E. Planning. 2010. *Beaufort Sea Oil Spills State of Knowledge Review and Identification of Key Issues*. Calgary, Alberta, Canada, Environmental Studies Research Funds: 126.
- 344 Brandvik, P. J. 2007. *Behaviour and Weathering of Oil Spills Under Arctic Conditions and Implications for Response*. International Oil & Ice Workshop, Anchorage, AK, Minerals Management Service.

345 Fingas, M. F. and B. P. Hollebone. 2002. *Behaviour of Oil in Freezing Environments: A Literature Review*. Arctic and Marine Oilspill Program Technical Seminar, Environment Canada.

346 DF Dickins Associates Ltd. and Fleet Technology Limited. 1992. *Behaviour of spilled oil at sea (BOSS): Oil-in-ice fate and behavior*.

Draft report submitted to Environment Canada, U.S. Minerals Management Service and American Petroleum Institute.

347 Cooke, Roger M., Ross, Heather L., and Stern, Adam, *Precursor Analysis for Offshore Oil and Gas Drilling*, Resources for the Future, RFF DP 10-61, Washington, D.C. January 2011.

